

STATE OF NORTH CAROLINA
DEPARTMENT OF TRANSPORTATION
RALEIGH, N.C.

C205035

CONTRACT AND
CONTRACT BONDS
FOR CONTRACT NO. C205035

WBS 39026.3.2 STATE FUNDED

T.I.P NO. U-3609B

COUNTY OF WAYNE

THIS IS THE ROADWAY & CULVERT CONTRACT

ROUTE NUMBER US-13 LENGTH 2.366 MILES

LOCATION US-13 (BERKELEY BLVD) FROM SR-1003 (NEW HOPE RD) TO US-70 BYPASS.

CONTRACTOR BRANCH CIVIL INC

ADDRESS P.O. BOX 40004
ROANOKE, VA 24022

BIDS OPENED FEBRUARY 17, 2026

CONTRACT EXECUTION 03/31/2026

STATE OF NORTH CAROLINA
DEPARTMENT OF TRANSPORTATION
RALEIGH, N.C.

PROPOSAL

DATE AND TIME OF BID OPENING: **Feb 17, 2026 AT 02:00 PM**

CONTRACT ID C205035
WBS 39026.3.2

FEDERAL-AID NO. STATE FUNDED
COUNTY WAYNE
T.I.P NO. U-3609B
MILES 2.366
ROUTE NO. US-13
LOCATION US-13 (BERKELEY BLVD) FROM SR-1003 (NEW HOPE RD) TO US-70
BYPASS.

TYPE OF WORK GRADING, DRAINAGE, PAVING, SIGNALS, AND CULVERT.

NOTICE:

ALL BIDDERS SHALL COMPLY WITH ALL APPLICABLE LAWS REGULATING THE PRACTICE OF GENERAL CONTRACTING AS CONTAINED IN CHAPTER 87 OF THE GENERAL STATUTES OF NORTH CAROLINA WHICH REQUIRES THE BIDDER TO BE LICENSED BY THE N.C. LICENSING BOARD FOR CONTRACTORS WHEN BIDDING ON ANY NON-FEDERAL AID PROJECT WHERE THE BID IS \$30,000 OR MORE, EXCEPT FOR CERTAIN SPECIALTY WORK AS DETERMINED BY THE LICENSING BOARD. BIDDERS SHALL ALSO COMPLY WITH ALL OTHER APPLICABLE LAWS REGULATING THE PRACTICES OF ELECTRICAL, PLUMBING, HEATING AND AIR CONDITIONING AND REFRIGERATION CONTRACTING AS CONTAINED IN CHAPTER 87 OF THE GENERAL STATUTES OF NORTH CAROLINA. NOTWITHSTANDING THESE LIMITATIONS ON BIDDING, THE BIDDER WHO IS AWARDED ANY FEDERAL - AID FUNDED PROJECT SHALL COMPLY WITH CHAPTER 87 OF THE GENERAL STATUTES OF NORTH CAROLINA FOR LICENSING REQUIREMENTS WITHIN 60 CALENDAR DAYS OF BID OPENING.

BIDS WILL BE RECEIVED AS SHOWN BELOW:

THIS IS A ROADWAY & CULVERT PROPOSAL

5% BID BOND OR BID DEPOSIT REQUIRED

**PROPOSAL FOR THE CONSTRUCTION OF
CONTRACT No. C205035 IN WAYNE COUNTY, NORTH CAROLINA
DEPARTMENT OF TRANSPORTATION,
RALEIGH, NORTH CAROLINA**

The Bidder has carefully examined the location of the proposed work to be known as Contract No. **C205035** has carefully examined the plans and specifications, which are acknowledged to be part of the proposal, the special provisions, the proposal, the form of contract, and the forms of contract payment bond and contract performance bond; and thoroughly understands the stipulations, requirements and provisions. The undersigned bidder agrees to bound upon his execution of the bid and subsequent award to him by the Board of Transportation in accordance with this proposal to provide the necessary contract payment bond and contract performance bond within fourteen days after the written notice of award is received by him. The undersigned Bidder further agrees to provide all necessary machinery, tools, labor, and other means of construction; and to do all the work and to furnish all materials, except as otherwise noted, necessary to perform and complete the said contract in accordance with the *2024 Standard Specifications for Roads and Structures* by the dates(s) specified in the Project Special Provisions and in accordance with the requirements of the Engineer, and at the unit or lump sum prices, as the case may be, for the various items given on the sheets contained herein.

The Bidder shall provide and furnish all the materials, machinery, implements, appliances and tools, and perform the work and required labor to construct and complete Contract No. **C205035** in **Wayne County**, for the unit or lump sum prices, as the case may be, bid by the Bidder in his bid and according to the proposal, plans, and specifications prepared by said Department, which proposal, plans, and specifications show the details covering this project, and hereby become a part of this contract.

The published volume entitled *North Carolina Department of Transportation, Raleigh, Standard Specifications for Roads and Structures, January 2024* with all amendments and supplements thereto, is by reference incorporated into and made a part of this contract; that, except as herein modified, all the construction and work included in this contract is to be done in accordance with the specifications contained in said volume, and amendments and supplements thereto, under the direction of the Engineer.

If the proposal is accepted and the award is made, the contract is valid only when signed either by the Contract Officer or such other person as may be designated by the Secretary to sign for the Department of Transportation. The conditions and provisions herein cannot be changed except over the signature of the said Contract Officer.

The quantities shown in the itemized proposal for the project are considered to be approximate only and are given as the basis for comparison of bids. The Department of Transportation may increase or decrease the quantity of any item or portion of the work as may be deemed necessary or expedient.

An increase or decrease in the quantity of an item will not be regarded as sufficient ground for an increase or decrease in the unit prices, nor in the time allowed for the completion of the work, except as provided for the contract.

Accompanying this bid is a bid bond secured by a corporate surety, or certified check payable to the order of the Department of Transportation, for five percent of the total bid price, which deposit is to be forfeited as liquidated damages in case this bid is accepted and the Bidder shall fail to provide the required payment and performance bonds with the Department of Transportation, under the condition of this proposal, within 14 calendar days after the written notice of award is received by him, as provided in the *Standard Specifications*; otherwise said deposit will be returned to the Bidder.



State Contract Officer

Signed by:

Ronald Elton Davenport, Jr.

5AE54B6DC24B4A9...

01/13/2026

TABLE OF CONTENTS

**COVER SHEET
PROPOSAL SHEET**

PROJECT SPECIAL PROVISIONS

HAUL ROADS:..... G-1
CONTRACT TIME AND LIQUIDATED DAMAGES: G-1
INTERMEDIATE CONTRACT TIME NUMBER 1 AND LIQUIDATED DAMAGES: G-1
INTERMEDIATE CONTRACT TIME NUMBER 2 AND LIQUIDATED DAMAGES: G-2
INTERMEDIATE CONTRACT TIME NUMBER 3 AND LIQUIDATED DAMAGES: G-3
INTERMEDIATE CONTRACT TIME NUMBER 4 AND LIQUIDATED DAMAGES: G-5
INTERMEDIATE CONTRACT TIME NUMBER 5 AND LIQUIDATED DAMAGES: G-5
INTERMEDIATE CONTRACT TIME NUMBER 6 AND LIQUIDATED DAMAGES: G-5
INTERMEDIATE CONTRACT TIME NUMBER 7 AND LIQUIDATED DAMAGES: G-6
PERMANENT VEGETATION ESTABLISHMENT:..... G-6
MAJOR CONTRACT ITEMS: G-7
SPECIALTY ITEMS:..... G-7
FUEL PRICE ADJUSTMENT:..... G-7
STEEL PRICE ADJUSTMENT:..... G-9
SCHEDULE OF ESTIMATED COMPLETION PROGRESS:..... G-20
MINORITY BUSINESS ENTERPRISE AND WOMEN BUSINESS ENTERPRISE:..... G-20
RESTRICTIONS ON ITS EQUIPMENT AND SERVICES:..... G-36
USE OF UNMANNED AIRCRAFT SYSTEM (UAS): G-36
EQUIPMENT IDLING GUIDELINES:..... G-36
SUBSURFACE INFORMATION:..... G-37
MAINTENANCE OF THE PROJECT: G-37
COOPERATION BETWEEN CONTRACTORS:..... G-38
TWELVE MONTH GUARANTEE:..... G-38
OUTSOURCING OUTSIDE THE USA:..... G-39
EROSION AND SEDIMENT CONTROL/STORMWATER CERTIFICATION: G-39
PROCEDURE FOR MONITORING BORROW PIT DISCHARGE:..... G-44
NOTE TO CONTRACTOR: G-46

ROADWAYR-1

STANDARD SPECIAL PROVISIONS

AVAILABILITY OF FUNDS – TERMINATION OF CONTRACTSSSP-1
NCDOT GENERAL SEED SPECIFICATION FOR SEED QUALITYSSP-2
ERRATA.....SSP-5
PLANT AND PEST QUARANTINESSSP-8
MINIMUM WAGESSSP-9
TITLE VI AND NONDISCRIMINATION:SSP-10
ON-THE-JOB TRAINING.....SSP-19

UNIT PROJECT SPECIAL PROVISIONS

GEOTECHNICAL.....GT-1.1
GEOENVIRONMENTAL..... GV-1
PAVEMENT MARKINGS PM-1
UTILITY CONSTRUCTION.....UC-1
UTILITY BY OTHERS..... UBO-1
EROSION CONTROL EC-1
TRAFFIC SIGNALSTS-1
STRUCTURE/CULVERTSST-1

PERMITS P-1

PROPOSAL ITEM SHEET

ITEM SHEET(S)

PROJECT SPECIAL PROVISIONS**GENERAL****HAUL ROADS:**

(7-16-24)

105

SP1 G04

Revise the *Standard Specifications* as follows:

Page 1-45, Article 105-15 RESTRICTION OF LOAD LIMITS, line 31, add the following after second sentence of the second paragraph:

At least 30 days prior to use, the Contractor shall notify the Engineer of any public road proposed for use as a haul road for the project.

CONTRACT TIME AND LIQUIDATED DAMAGES:

(7-1-95) (Rev. 5-16-23)

108

SP1 G08 A

The date of availability for this contract is **June 1, 2026**, except that work in jurisdictional waters and wetlands shall not begin until a meeting between NCDOT, Regulatory Agencies, and the Contractor is held as stipulated in the permits contained elsewhere in this proposal. This delay in availability has been considered in determining the contract time for this project.

The completion date for this contract is **March 30, 2030**.

Except where otherwise provided by the contract, observation periods required by the contract will not be a part of the work to be completed by the completion date and/or intermediate contract times stated in the contract. The acceptable completion of the observation periods that extend beyond the final completion date shall be a part of the work covered by the performance and payment bonds.

The liquidated damages for this contract are **Two Hundred Dollars (\$200.00)** per calendar day. These liquidated damages will not be cumulative with any liquidated damages which may become chargeable under Intermediate Contract Time Number 1.

INTERMEDIATE CONTRACT TIME NUMBER 1 AND LIQUIDATED DAMAGES:

(12-18-07) (Rev. 2-21-12)

108

SP1 G13 A

Except for that work required under the Project Special Provisions entitled *Planting, Reforestation* and/or *Permanent Vegetation Establishment*, included elsewhere in this proposal, the Contractor will be required to complete all work included in this contract and shall place and maintain traffic on same.

The date of availability for this intermediate contract time is **June 1, 2026**.

The completion date for this intermediate contract time is **October 1, 2029**.

The liquidated damages for this intermediate contract time are **Three Thousand Seven Hundred Dollars (\$3,700.00)** per calendar day.

Upon apparent completion of all the work required to be completed by this intermediate date, a final inspection will be held in accordance with Article 105-17 and upon acceptance, the Department will assume responsibility for the maintenance of all work except *Planting, Reforestation* and/or *Permanent Vegetation Establishment*. The Contractor will be responsible for and shall make corrections of all damages to the completed roadway caused by his planting operations, whether occurring prior to or after placing traffic through the project.

INTERMEDIATE CONTRACT TIME NUMBER 2 AND LIQUIDATED DAMAGES:

(2-20-07)

108

SP1 G14 A

The Contractor shall complete the required work of installing, maintaining, and removing the traffic control devices for lane closures and restoring traffic to the existing traffic pattern. The Contractor shall not close or narrow a lane of traffic on **-L- (US 13)** during the following time restrictions:

DAY AND TIME RESTRICTIONS

Monday thru Friday, 6:00 AM to 9:00 AM and 4:00 PM to 7:00PM

These Day and Time Restrictions do not apply to the long-term directional closure required during Phase I, Step #0 as detailed in the Transportation Management Plan. However, they do apply to any short-term lane closure installed during this long-term directional closure traffic pattern.

In addition, the Contractor shall not close or narrow a lane of traffic on **-L- (US 13)**, detain and/or alter the traffic flow on or during holidays, holiday weekends, special events, or any other time when traffic is unusually heavy, including the following schedules:

HOLIDAY AND HOLIDAY WEEKEND LANE CLOSURE RESTRICTIONS

1. For **unexpected occurrence** that creates unusually high traffic volumes, as directed by the Engineer.
2. For **New Year's Day**, between the hours of **6:00 AM** December 31st and **7:00 PM** January 2nd. If New Year's Day is on a Friday, Saturday, Sunday or Monday, then until **7:00 PM** the following Tuesday.
3. For **Easter**, between the hours of **6:00 AM** Thursday and **7:00 PM** Monday.
4. For **Memorial Day**, between the hours of **6:00 AM** Friday and **7:00 PM** Tuesday.
5. For **Independence Day**, between the hours of **6:00 AM** the day before Independence Day and **7:00 PM** the day after Independence Day.

If **Independence Day** is on a Friday, Saturday, Sunday or Monday, then between the hours of **6:00 AM** the Thursday before Independence Day and **7:00 PM** the Tuesday after Independence Day.

6. For **Labor Day**, between the hours of **6:00 AM** Friday and **7:00 PM** Tuesday.
7. For **Thanksgiving**, between the hours of **6:00 AM** Tuesday and **7:00 PM** Monday.
8. For **Christmas**, between the hours of **6:00 AM** the Friday before the week of Christmas Day and **7:00 PM** the following Tuesday after the week of Christmas Day.
9. For **Wings over Wayne Air Show**, between the hours of **7:00 PM** the Friday before the event to **6:00 AM** the Monday after the event.

Holidays and holiday weekends shall include New Year's, Easter, Memorial Day, Independence Day, Labor Day, Thanksgiving, and Christmas. The Contractor shall schedule his work so that lane closures will not be required during these periods, unless otherwise directed by the Engineer.

The time of availability for this intermediate contract work shall be the time the Contractor begins to install all traffic control devices for lane closures according to the time restrictions listed herein.

The completion time for this intermediate contract work shall be the time the Contractor is required to complete the removal of all traffic control devices for lane closures according to the time restrictions stated above and place traffic in the existing traffic pattern.

The liquidated damages are **Two Hundred Fifty Dollars (\$ 250.00)** per fifteen (15) minute time period.

INTERMEDIATE CONTRACT TIME NUMBER 3 AND LIQUIDATED DAMAGES:

(2-20-07)

108

SP1 G14 A

The Contractor shall complete the required work of installing, maintaining, and removing the traffic control devices for lane closures and restoring traffic to the existing traffic pattern. The Contractor shall not close or narrow a lane of traffic on **-Y1- (New Hope Road)** or **-Y11- (Tommys Road)** during the following time restrictions:

DAY AND TIME RESTRICTIONS

Monday thru Friday, 6:00 AM to 9:00 AM and 4:00 PM to 7:00PM

For -Y1- (New Hope Road), these Day and Time Restrictions do not apply to the long-term directional closure required during Phase I, Step #0 as detailed in the Transportation Management Plan. However, they do apply to any short-term lane closure installed during this long-term directional closure traffic pattern.

In addition, the Contractor shall not close or narrow a lane of traffic on **-Y1- (New Hope Road) or -Y11- (Tommys Road)**, detain and/or alter the traffic flow on or during holidays, holiday weekends, special events, or any other time when traffic is unusually heavy, including the following schedules:

HOLIDAY AND HOLIDAY WEEKEND LANE CLOSURE RESTRICTIONS

1. For **unexpected occurrence** that creates unusually high traffic volumes, as directed by the Engineer.
2. For **New Year's Day**, between the hours of **6:00 AM** December 31st and **7:00 PM** January 2nd. If New Year's Day is on a Friday, Saturday, Sunday or Monday, then until **7:00 PM** the following Tuesday.
3. For **Easter**, between the hours of **6:00 AM** Thursday and **7:00 PM** Monday.
4. For **Memorial Day**, between the hours of **6:00 AM** Friday and **7:00 PM** Tuesday.
5. For **Independence Day**, between the hours of **6:00 AM** the day before Independence Day and **7:00 PM** the day after Independence Day.

If **Independence Day** is on a Friday, Saturday, Sunday or Monday, then between the hours of **6:00 AM** the Thursday before Independence Day and **7:00 PM** the Tuesday after Independence Day.
6. For **Labor Day**, between the hours of **6:00 AM** Friday and **7:00 PM** Tuesday.
7. For **Thanksgiving**, between the hours of **6:00 AM** Tuesday and **7:00 PM** Monday.
8. For **Christmas**, between the hours of **6:00 AM** the Friday before the week of Christmas Day and **7:00 PM** the following Tuesday after the week of Christmas Day.
9. For **Wings over Wayne Air Show**, between the hours of **7:00 PM** the Friday before the event to **6:00 AM** the Monday after the event.

Holidays and holiday weekends shall include New Year's, Easter, Memorial Day, Independence Day, Labor Day, Thanksgiving, and Christmas. The Contractor shall schedule his work so that lane closures will not be required during these periods, unless otherwise directed by the Engineer.

The time of availability for this intermediate contract work shall be the time the Contractor begins to install all traffic control devices for lane closures according to the time restrictions listed herein.

The completion time for this intermediate contract work shall be the time the Contractor is required to complete the removal of all traffic control devices for lane closures according to the time restrictions stated above and place traffic in the existing traffic pattern.

The liquidated damages are **Two Hundred Fifty Dollars (\$ 250.00)** per hour.

INTERMEDIATE CONTRACT TIME NUMBER 4 AND LIQUIDATED DAMAGES:

(2-20-07) (Rev. 6-18-13)

108

SPI G14 G

The Contractor shall complete the work required of **Phase I, Step #0** as shown on Sheet **TMP-3** and shall place and maintain traffic on same.

The time of availability for this intermediate contract time is the time the Contractor begins the work.

The completion date for this intermediate contract time is the date which is **two hundred forty (240)** consecutive hours after the Contractor begins this work.

The Date and Time Restrictions listed in Intermediate Contract Time Number 2 and Intermediate Contract Time Number 3 do not apply to the long-term directional closure permitted by this intermediate contract time. However, Holiday and Holiday Weekend Lane Closure Restrictions shall apply to the long-term directional closure permitted by this intermediate contract time.

The liquidated damages are **Five Hundred Dollars (\$ 500.00)** per fifteen (15) minute time period.

INTERMEDIATE CONTRACT TIME NUMBER 5 AND LIQUIDATED DAMAGES:

(2-20-07) (Rev. 6-18-13)

108

SPI G14 H

The Contractor shall complete the work required of **Phase I, Step #1** as shown on Sheet **TMP-3** and shall place and maintain traffic on same.

The date of availability for this intermediate contract time is the date the Contractor elects to begin the work.

The completion date for this intermediate contract time is the date which is **ninety (90)** consecutive calendar days after and including the date the Contractor begins this work.

The liquidated damages are **Five Thousand Dollars (\$ 5,000.00)** per calendar day.

INTERMEDIATE CONTRACT TIME NUMBER 6 AND LIQUIDATED DAMAGES:

(2-20-07) (Rev. 6-18-13)

108

SPI G14 F

The Contractor shall complete the work required of **Phase I, Step #2A, Location #1** as shown on Sheet **TMP-3** and shall place and maintain traffic on same.

The time of availability for this intermediate contract time is the **Friday at 7:00 PM** that the Contractor elects to begin the work.

The completion time for this intermediate contract time is the following **Monday at 6:00 AM** after the time of availability.

The liquidated damages are **One Thousand Five Hundred Dollars (\$ 1,500.00)** per fifteen (15) minute time period.

INTERMEDIATE CONTRACT TIME NUMBER 7 AND LIQUIDATED DAMAGES:

(2-20-07) (Rev. 6-18-13)

108

SP1 G14 F

The Contractor shall complete the work required of **Phase I, Step #2A, Location #2** as shown on Sheet **TMP-3** and shall place and maintain traffic on same.

The time of availability for this intermediate contract time is the **Friday at 7:00 PM** that the Contractor elects to begin the work.

The completion time for this intermediate contract time is the following **Monday at 6:00 AM** after the time of availability.

The liquidated damages are **One Thousand Five Hundred Dollars (\$ 1,500.00)** per fifteen (15) minute time period.

PERMANENT VEGETATION ESTABLISHMENT:

(2-16-12)(Rev. 1-16-24)

104

SP1 G16

Establish a permanent stand of the vegetation mixture shown in the contract. During the period between initial vegetation planting and final project acceptance, perform all work necessary to establish permanent vegetation on all erodible areas within the project limits, as well as, in borrow and waste pits. This work shall include erosion control device maintenance and installation, repair seeding and mulching, supplemental seeding and mulching, mowing, and fertilizer topdressing, as directed. All work shall be performed in accordance with the applicable section of the *Standard Specifications*. All work required for initial vegetation planting shall be performed as a part of the work necessary for the completion and acceptance of the Intermediate Contract Time (ICT). Between the time of ICT and Final Project acceptance, or otherwise referred to as the vegetation establishment period, the Department will be responsible for preparing the required National Pollutant Discharge Elimination System (NPDES) inspection records.

Once the Engineer has determined that the permanent vegetation establishment requirement has been achieved at an 80% vegetation density (the amount of established vegetation per given area to stabilize the soil) and no erodible areas exist within the project limits, the Contractor will be notified to remove the remaining erosion control devices that are no longer needed. The Contractor will be responsible for, and shall correct any areas disturbed by operations performed in permanent vegetation establishment and the removal of temporary erosion control measures, whether occurring prior to or after placing traffic on the project.

Payment for *Response for Erosion Control, Seeding and Mulching, Repair Seeding, Supplemental Seeding, Mowing, Fertilizer Topdressing, Silt Excavation, and Stone for Erosion Control* will be made at contract unit prices for the affected items. Work required that is not represented by contract line items will be paid in accordance with Articles 104-7 or 104-3 of the *Standard Specifications*. No additional compensation will be made for maintenance and removal of temporary erosion control items.

MAJOR CONTRACT ITEMS:

(2-19-02)(Rev. 1-16-24)

104

SP1 G28

The following listed items are the major contract items for this contract (see Article 104-5 of the *Standard Specifications*):

Line #	Description
6	Borrow Excavation
38	Asphalt Conc Base Course, Type B25.0C
39	Asphalt Conc Intermediate Course, Type I19.0C
41	Asphalt Conc Surface Course, Type S9.5C
125	16" Water Line

SPECIALTY ITEMS:

(7-1-95)(Rev. 1-16-24)

108-6

SP1 G37

Items listed below will be the specialty items for this contract (see Article 108-6 of the *Standard Specifications*).

Line #	Description
75-80	Guardrail
84-94	Signing
108-111, 120	Long-Life Pavement Markings
121	Permanent Pavement Markers
122-141	Utility Construction
142-174, 176	Erosion Control
175	Reforestation
177-218	Signals/ITS System

FUEL PRICE ADJUSTMENT:

(11-15-05)(Rev. 1-16-24)

109-8

SP1 G43

Page 1-82, Article 109-8, FUEL PRICE ADJUSTMENTS, add the following:

The base index price for DIESEL #2 FUEL is \$ **2.2685** per gallon. Where any of the following are included as pay items in the contract, they will be eligible for fuel price adjustment.

The pay items and the fuel factor used in calculating adjustments to be made will be as follows:

Description	Units	Fuel Usage Factor Diesel
Unclassified Excavation	Gal/CY	0.29
Borrow Excavation	Gal/CY	0.29
Class IV Subgrade Stabilization	Gal/Ton	0.55
Aggregate Base Course	Gal/Ton	0.55
Sub-Ballast	Gal/Ton	0.55
Erosion Control Stone	Gal/Ton	0.55
Rip Rap, Class _____	Gal/Ton	0.55
Asphalt Concrete Base Course, Type _____	Gal/Ton	0.90 or 2.90
Asphalt Concrete Intermediate Course, Type _____	Gal/Ton	0.90 or 2.90
Asphalt Concrete Surface Course, Type _____	Gal/Ton	0.90 or 2.90
Open-Graded Asphalt Friction Course	Gal/Ton	0.90 or 2.90
Permeable Asphalt Drainage Course, Type _____	Gal/Ton	0.90 or 2.90
Sand Asphalt Surface Course, Type _____	Gal/Ton	0.90 or 2.90
Ultra-thin Bonded Wearing Course	Gal/Ton	0.90 or 2.90
Aggregate for Cement Treated Base Course	Gal/Ton	0.55
Portland Cement for Cement Treated Base Course	Gal/Ton	0.55
> 11" Portland Cement Concrete Pavement	Gal/SY	0.327
Concrete Shoulders Adjacent to > 11" Pavement	Gal/SY	0.327
9" to 11" Portland Cement Concrete Pavement	Gal/SY	0.272
Concrete Shoulders Adjacent to 9" to 11" Pavement	Gal/SY	0.272
< 9" Portland Cement Concrete Pavement	Gal/SY	0.245
Concrete Shoulders Adjacent to < 9" Pavement	Gal/SY	0.245

For the asphalt items noted in the chart as eligible for fuel adjustments, the bidder may include the *Fuel Usage Factor Adjustment Form* with their bid submission if they elect to use the fuel usage factor. The *Fuel Usage Factor Adjustment Form* is found at the following link:

<https://connect.ncdot.gov/letting/LetCentral/Fuel%20Usage%20Factor%20Adjustment%20Form%20-%20Starting%20Nov%202022%20Lettings.pdf>

Select either 2.90 Gal/Ton fuel factor or 0.90 Gal/Ton fuel factor for each asphalt line item on the *Fuel Usage Factor Adjustment Form*. The selected fuel factor for each asphalt item will remain in effect for the duration of the contract.

Failure to complete the *Fuel Usage Factor Adjustment Form* will result in using 2.90 gallons per ton as the Fuel Usage Factor for Diesel for the asphalt items noted above. The contractor will not be permitted to change the Fuel Usage Factor after the bids are submitted.

STEEL PRICE ADJUSTMENT:

(4-19-22)(Rev. 12-20-22)

SP1 G47

Description and Purpose

Steel price adjustments will be made to the payments due the Contractor for items as defined herein that are permanently incorporated into the work, when the price of raw steel mill products utilized on the contract have fluctuated. The Department will adjust monthly progress payments up or down as appropriate for cost changes in steel according to this provision.

Eligible Items

The list of eligible bid items for steel price adjustment can be found on the Departments website at the following address:

<https://connect.ncdot.gov/letting/LetCentral/Eligible%20Bid%20Items%20for%20Steel%20Price%20Adjustment.xlsx>

Nuts, bolts, anchor bolts, rebar chairs, connecting bands and other miscellaneous hardware associated with these items shall not be included in the price adjustment.

Adjustments will only be made for fluctuations in the material cost of the steel used in the above products as specified in the Product Relationship Table below. The producing mill is defined as the source of steel product before any fabrication has occurred (e.g., coil, plate, rebar, hot rolled shapes, etc.). No adjustment will be made for changes in the cost of fabrication, coating, shipping, storage, etc.

No steel price adjustments will be made for any products manufactured from steel having an adjustment date, as defined by the Product Relationship Table below, prior to the letting date.

Bid Submittal Requirements

The successful bidder, within 14 calendar days after the notice of award is received by him, shall provide the completed Form SPA-1 to the Department (State Contract Officer or Division Contract Engineer) along with the payment bonds, performance bonds and contract execution signature sheets in a single submittal. If Form SPA-1 is not included in the same submittal as the payment bonds, performance bonds and contract execution signature sheets, the Contractor will not be eligible for any steel price adjustment for any item in the contract for the life of the contract. Form SPA-1 can be found on the Department's website at the following address:

<https://connect.ncdot.gov/letting/LetCentral/Form%20SPA-1.xlsm>

The Contractor shall provide Form SPA-1 listing the Contract Line Number, (with corresponding Item Number, Item Description, and Category) for the steel products they wish to have an adjustment calculated. Only the contract items corresponding to the list of eligible item numbers for steel price adjustment may be entered on Form SPA-1. The Contractor may choose to have steel price adjustment applied to any, all, or none of the eligible items. However, the Contractor's selection of items for steel price adjustment or non-selection (non-participation)

may not be changed once Form SPA-1 has been received by the Department. Items the Bidder chooses for steel price adjustment must be designated by writing the word “Yes” in the column titled “Option” by each Pay Item chosen for adjustment. Should the bidder elect an eligible steel price item, the entire quantity of the line item will be subject to the price adjustment for the duration of the Contract. The Bidder’s designations on Form SPA-1 must be written in ink or typed and signed by the Bidder (Prime Contractor) to be considered complete. Items not properly designated, designated with “No”, or left blank on the Bidder’s Form SPA-1 will automatically be removed from consideration for adjustment. No steel items will be eligible for steel price adjustment on this Project if the Bidder fails to return Form SPA-1 in accordance with this provision.

Establishing the Base Price

The Department will use a blend of monthly average prices as reported from the Fastmarkets platform to calculate the monthly adjustment indices (BI and MI). This data is typically available on the first day of the month for the preceding month. The indices will be calculated by the Department for the different categories found on the Product Relationship Table below. For item numbers that include multiple types of steel products, the category listed for that item number will be used for adjusting each steel component.

The bidding index for Category 1 Steel items is **\$ 46.50** per hundredweight.
 The bidding index for Category 2 Steel items is **\$ 51.88** per hundredweight.
 The bidding index for Category 3 Steel items is **\$ 69.45** per hundredweight.
 The bidding index for Category 4 Steel items is **\$ 47.54** per hundredweight.
 The bidding index for Category 5 Steel items is **\$ 54.81** per hundredweight.
 The bidding index for Category 6 Steel items is **\$ 61.06** per hundredweight.
 The bidding index for Category 7 Steel items is **\$ 48.15** per hundredweight.

The bidding index represents a selling price of steel based on Fastmarkets data for the month of **December 2025**.

- MI = Monthly Index. – in Dollars (\$) per hundredweight (CWT). Use the adjustment indices from the month the steel was shipped from the producing mill, received on the project, or member cast as defined in the Product Relationship Table.
- BI = Bidding Index. - in Dollars (\$) per hundredweight (CWT). Use the adjustment indices as listed in the proposal.

<i>Product Relationship Table</i>			
<i>Steel Product (Title)</i>	BI, MI*	Adjustment Date for MI	Category
Reinforcing Steel, Bridge Deck, and SIP Forms	Based on one or more Fastmarkets indices	Delivery Date from Producing Mill	1
Structural Steel and Encasement Pipe	Based on one or more Fastmarkets indices	Delivery Date from Producing Mill	2
Steel H-Piles, Soldier Pile Walls	Based on one or more Fastmarkets indices	Delivery Date from Producing Mill	3
Guardrail Items and Pipe	Based on one or more	Material Received Date**	4

Piles	Fastmarkets indices		
Fence Items	Based on one or more Fastmarkets indices	Material Received Date**	5
Overhead Sign Assembly, Signal Poles, High Mount Standards	Based on one or more Fastmarkets indices	Material Received Date**	6
Prestressed Concrete Members	Based on one or more Fastmarkets indices	Cast Date of Member	7
* BI and MI are in converted units of Dollars per Hundredweight (\$/CWT)			
** Material Received Date is defined as the date the materials are received on the project site. If a material prepayment is made for a Category 4-6 item, the Adjustment Date to be used will be the date of the prepayment request instead of the Materials Received Date.			

Submit documentation to the Engineer for all items listed in the Contract for which the Contractor is requesting a steel price adjustment.

Submittal Requirements

The items in categories 1,2, and 3, shall be specifically stored, labeled, or tagged, recognizable by color marking, and identifiable by Project for inspection and audit verification immediately upon arrival at the fabricator.

Furnish the following documentation for all steel products to be incorporated into the work and documented on Form SPA-2, found on the Departments website at the following address:

<https://connect.ncdot.gov/projects/construction/Construction%20Forms/Form%20SPA-2.xlsx>

Submit all documentation to the Engineer prior to incorporation of the steel into the completed work. The Department will withhold progress payments for the affected contract line item if the documentation is not provided and at the discretion of the Engineer the work is allowed to proceed. Progress payments will be made upon receipt of the delinquent documentation.

Step 1 (Form SPA -2)

Utilizing Form SPA-2, submit separate documentation packages for each line item from Form SPA-1 for which the Contractor opted for a steel price adjustment. For line items with multiple components of steel, each component should be listed separately. Label each SPA-2 documentation package with a unique number as described below.

- a. Documentation package number: (Insert the contract line-item) - (Insert sequential package number beginning with "1").

Example: 412 - 1,
412 - 2,
424 - 1,
424 - 2,
424 - 3, etc.

- b. The steel product quantity in pounds

- i. The following sources should be used, in declining order of precedence, to determine the weight of steel/iron, based on the Engineers decision:
 1. Department established weights of steel/iron by contract pay item per pay unit;
 2. Approved Shop Drawings;
 3. Verified Shipping Documents;
 4. Contract Plans;
 5. Standard Drawing Sheets;
 6. Industry Standards (i.e., AISC Manual of Steel Construction, AWWA Standards, etc.); and
 7. Manufacture's data.
- ii. Any item requiring approved shop drawings shall have the weights of steel calculated and shown on the shop drawings or submitted and certified separately by the fabricator.
- c. The date the steel product, subject to adjustment, was shipped from the producing mill (Categories 1-3), received on the project (Categories 4-6), or casting date (Category 7).

Step 2 (Monthly Calculator Spreadsheet)

For each month, upon the incorporation of the steel product into the work, provide the Engineer the following:

- 1) Completed NCDOT Steel Price Adjustment Calculator Spreadsheet, summarizing all the steel submittal packages (Form SPA-2) actually incorporated into the completed work in the given month.
 - a. Contract Number
 - b. Bidding Index Reference Month
 - c. Contract Completion Date or Revised Completion Date
 - d. County, Route, and Project TIP information
 - e. Item Number
 - f. Line-Item Description
 - g. Submittal Number from Form SPA-2
 - h. Adjustment date
 - i. Pounds of Steel
- 2) An affidavit signed by the Contractor stating the documentation provided in the NCDOT Steel Price Adjustment Calculator Spreadsheet is true and accurate.

Price Adjustment Conditions

Download the Monthly Steel Adjustment Spreadsheet with the most current reference data from the Department's website each month at the following address:

<https://connect.ncdot.gov/projects/construction/Construction%20Forms/Form%20SPA-3%20NCDOT%20Steel%20Price%20Adjustment%20Calculator.xlsx>

If the monthly Fastmarkets data is not available, the data for the most recent immediately preceding month will be used as the basis for adjustment.

Price Adjustment Calculations

The price adjustment will be determined by comparing the percentage of change in index value listed in the proposal (BI) to the monthly index value (MI). (See included sample examples). Weights and date of shipment must be documented as required herein. The final price adjustment dollar value will be determined by multiplying this percentage increase or decrease in the index by the represented quantity of steel incorporated into the work, and the established bidding index (BI) subject to the limitations herein.

Price increase/decrease will be computed as follows:

$$\text{SPA} = ((\text{MI} / \text{BI}) - 1) * \text{BI} * (\text{Q} / 100)$$

Where;

SPA = Steel price adjustment in dollars

MI = Monthly Shipping Index. – in Dollars (\$) per hundredweight (CWT). Use the adjustment indices from the month the steel was shipped from the producing mill, received on the project, or member cast as defined in the Product Relationship Table.

BI = Bidding Index. - in Dollars (\$) per hundredweight (CWT). Use the adjustment indices as listed in the proposal.

Q = Quantity of steel, product, pounds actually incorporated into the work as documented by the Contractor, or Design Build Team and verified by the Engineer.

Calculations for price adjustment shall be shown separate from the monthly progress estimate and will not be included in the total cost of work for determination of progress or for extension of Contract time in accordance with Subarticle 108-10(B)(1).

Any apparent attempt to unbalance bids in favor of items subject to price adjustment may result in rejection of the bid proposal.

Adjustments will be paid or charged to the Contractor only. Any Contractor receiving an adjustment under this provision shall distribute the proper proportional part of such adjustments to the subcontractor who performed the applicable work.

Delays to the work caused by steel shortages may be justification for a Contract time extension but will not constitute grounds for claims for standby equipment, extended office overhead, or other costs associated with such delays.

If an increase in the steel material price is anticipated to exceed 50% of the original quoted price, the contractor must notify the Department within 7 days prior to purchasing the material. Upon receipt of such notification, the Department will direct the Contractor to either (1) proceed with the work or (2) suspend the work and explore the use of alternate options.

If the decrease in the steel material exceeds 50% of the original quoted price, the contractor may submit to the Department additional market index information specific to the item in question to dispute the decrease. The Department will review this information and determine if the decrease is warranted.

When the steel product adjustment date, as defined in the Product Relationship Table, is after the approved contract completion date, the steel price adjustments will be based on the lesser value of either the MI for the month of the approved contract completion date or the MI for the actual adjustment date.

If the price adjustment is based on estimated material quantities for that time, and a revision to the total material quantity is made in a subsequent or final estimate, an appropriate adjustment will be made to the price adjustment previously calculated. The adjustment will be based on the same indices used to calculate the price adjustment which is being revised. If the adjustment date of the revised material quantity cannot be determined, the adjustment for the quantity in question, will be based on the indices utilized to calculate the steel price adjustment for the last initial documentation package submission, for the steel product subject to adjustment, that was incorporated into the particular item of work, for which quantities are being finalized.

Example: Structural steel for a particular bridge was provided for in three different shipments with each having a different mill shipping date. The quantity of structural steel actually used for the bridge was calculated and a steel price adjustment was made in a progress payment. At the conclusion of the work an error was found in the plans of the final quantity of structural steel used for the bridge. The quantity to be adjusted cannot be directly related to any one of the three mill shipping dates. The steel price adjustment for the quantity in question would be calculated using the indices that were utilized to calculate the steel price adjustment for the quantity of structural steel represented by the last initial structural steel documentation package submission. The package used will be the one with the greatest sequential number.

Extra Work/Force Account:

When steel products, as specified herein, are added to the contract as extra work, in accordance with the provisions of Article 104-7 or 104-3, the Engineer will determine and specify in the supplemental agreement, the need for application of steel price adjustments on a case-by-case basis. No steel price adjustments will be made for any products manufactured from steel having an adjustment date prior to the supplemental agreement execution date. Price adjustments will be made as provided herein, except the Bidding Index will be based on the month in which the supplemental agreement pricing was executed.

For work performed on force account basis, reimbursement of actual material costs, along with the specified overhead and profit markup, will be considered to include full compensation for the current cost of steel and no steel price adjustments will be made.

Examples Form SPA-2

Steel Price Adjustment Submission Form

Contract Number C203394 Bid Reference Month January 2019

Submittal Date 8/31/2019

Contract Line Item 237

Line Item Description APPROX....LBS Structural Steel

Sequential Submittal Number 2

Supplier	Description of material	Location information	Quantity in lbs.	Adjustment Date
XYZ mill	Structural Steel	Structure 3, Spans A-C	1,200,000	May 4, 2020
ABC distributing	Various channel & angle shapes	Structure 3 Spans A-C	35,000	July 14, 2020
		Total Pounds of Steel	1,235,000	

- Note: Attach the following supporting documentation to this form.
- Bill of Lading to support the shipping dates
 - Supporting information for weight documentation (e.g., Pay item reference, Shop drawings, shipping documents, Standards Sheets, industry standards, or manufacturer's data)

By providing this data under my signature, I attest to the accuracy of and validity of the data on this form and certify that no deliberate misrepresentation in any manner has occurred.

Printed Name

Signature

Examples Form SPA-2
Steel Price Adjustment Submission Form

Contract Number C203394 Bid Reference Month January 2019

Submittal Date August 31, 2019

Contract Line Item 237

Line Item Description SUPPORT, OVRHD SIGN STR -DFEB – STA 36+00

Sequential Submittal Number 2

Supplier	Description of material	Location information	Quantity in lbs.	Adjustment Date
XYZ mill	Tubular Steel (Vertical legs)	<u>-DFEB – STA 36+00</u>	12000	December 11, 2021
PDQ Mill	4” Tubular steel (Horizontal legs)	<u>-DFEB – STA 36+00</u>	5900	December 11, 2021
ABC distributing	Various channel & angle shapes (see quote)	<u>-DFEB – STA 36+00</u>	1300	December 11, 2021
	Catwalk assembly	<u>-DFEB – STA 36+00</u>	2000	December 11, 2021
Nucor	Flat plate	<u>-DFEB – STA 36+00</u>	650	December 11, 2021
		Total Pounds of Steel	21,850	

Note: Attach the following supporting documentation to this form.

- Bill of Lading to support the shipping dates
- Supporting information for weight documentation (e.g., Pay item reference, Shop drawings, shipping documents, Standards Sheets, industry standards, or manufacturer's data)

By providing this data under my signature, I attest to the accuracy of and validity of the data on this form and certify that no deliberate misrepresentation in any manner has occurred.

Printed Name

Signature

Price Adjustment Sample Calculation (increase)

Project bid on September 17, 2019

Line Item 635 "Structural Steel" has a plan quantity of 2,717,000 lbs.

Bidding Index for Structural Steel (Category 2) in the proposal was \$36.12/CWT = BI

450,000 lbs. of Structural Steel for Structure 2 at Station 44+08.60 were shipped to fabricator from the producing mill in same month, May 2021.

Monthly Index for Structural Steel (Category 2) for May 2021 was \$64.89/CWT = MI

The Steel Price Adjustment formula is as follows:

$$\text{SPA} = ((\text{MI} / \text{BI}) - 1) * \text{BI} * (\text{Q} / 100)$$

Where; SPA = Steel price adjustment in dollars

BI = Bidding Index – in dollars (\$) per hundredweight (CWT). Use the adjustment indices as listed in the proposal.

MI = Mill Shipping Index – in dollars (\$) per hundredweight (CWT). Use the adjustment indices from the month the steel was shipped from the producing mill, received on the project, or member cast as defined in the Product Relationship Table.

Q = Quantity of steel product, in pounds (lbs.) actually incorporated into the work as documented by the Contractor, or Design Build Team and verified by the Engineer.

$$\text{BI} = \$36.12 / \text{CWT}$$

$$\text{MI} = \$64.89 / \text{CWT}$$

$$\% \text{ change} = ((\text{MI} / \text{BI}) - 1) = (\$64.89 / \$36.12 - 1) = (1.79651 - 1) = 0.79651162791$$

$$\text{Q} = 450,000 \text{ lbs.}$$

$$\text{SPA} = 0.79651162791 \times \$36.12 \times (450,000 / 100)$$

$$\text{SPA} = 0.79651162791 * \$36.12 * 4,500$$

$$\text{SPA} = \$129,465 \text{ pay adjustment to Contractor for Structural Steel (Structure 2 at Station 44+08.60)}$$

Price Adjustment Sample Calculation (decrease)

Project bid on December 18, 2018

Line Item 635 Structural Steel has a plan quantity of 2,717,000 lbs.

Bidding Index for Structural Steel (Category 2) in the proposal was \$46.72/CWT = BI

600,000 lbs. of Structural Steel for Structure 1 at Station 22+57.68 were shipped to fabricator from the producing mill in same month, August 2020.

Monthly Index for Structural Steel (Category 2) for August 2020 was \$27.03/CWT = MI

The Steel Price Adjustment formula is as follows:

$$\text{SPA} = ((\text{MI} / \text{BI}) - 1) * \text{BI} * (\text{Q} / 100)$$

Where; SPA = Steel price adjustment in dollars

BI = Bidding Index – in dollars (\$) per hundredweight (CWT). Use the adjustment indices as listed in the proposal.

MI = Mill Shipping Index – in dollars (\$) per hundredweight (CWT). Use the adjustment indices from the month the steel was shipped from the producing mill, received on the project, or member cast as defined in the Product Relationship Table.

Q = Quantity of steel product, in pounds (lbs.) actually incorporated into the work as documented by the Contractor, or Design Build Team and verified by the Engineer.

$$\text{BI} = \$46.72 / \text{CWT}$$

$$\text{MI} = \$27.03 / \text{CWT}$$

$$\% \text{ change} = ((\text{MI} / \text{BI}) - 1) = (\$27.03 / \$46.72 - 1) = (0.57855 - 1) = -0.421446917808$$

$$\text{Q} = 600,000 \text{ lbs.}$$

$$\text{SPA} = -0.421446917808 * \$46.72 * (600,000 / 100)$$

$$\text{SPA} = -0.421446917808 * \$46.72 * 6,000$$

$$\text{SPA} = \$ 118,140.00 \text{ Credit to the Department for Structural Steel (Structure 1 at Station 22+57.68)}$$

Price Adjustment Sample Calculation (increase)

Project bid on July 16, 2020

Line Item 614 Reinforced Concrete Deck Slab has a plan quantity of 241974 lbs.

Bidding Index Reference Month was May 2020. Bidding Index for Reinforced Concrete Deck Slab (Category 1) in the proposal was \$29.21/CWT = BI

51,621 lbs. of reinforcing steel and 52,311 lbs. of epoxy coated reinforcing steel for Structure 2 at Station 107+45.55 -L- was shipped to fabricator from the producing mill in same month, May 2021.

Monthly Index for Reinforced Concrete Deck Slab (Category 1) for May 2021 was \$43.13/CWT = MI

The Steel Price Adjustment formula is as follows:

$$\text{SPA} = ((\text{MI} / \text{BI}) - 1) * \text{BI} * (\text{Q} / 100)$$

Where; SPA = Steel price adjustment in dollars

BI = Bidding Index – in dollars (\$) per hundredweight (CWT). Use the adjustment indices as listed in the proposal.

MI = Mill Shipping Index – in dollars (\$) per hundredweight (CWT). Use the adjustment indices from the month the steel was shipped from the producing mill, received on the project, or member cast as defined in the Product Relationship Table.

Q = Quantity of steel product, in pounds (lbs.) actually incorporated into the work as documented by the Contractor, or Design Build Team and verified by the Engineer.

$$\text{BI} = \$29.21 / \text{CWT}$$

$$\text{MI} = \$43.13 / \text{CWT}$$

$$\% \text{ change} = ((\text{MI} / \text{BI}) - 1) = (\$43.13 / \$29.21 - 1) = (1.47655 - 1) = 0.47654912701$$

$$\text{Q} = 103932 \text{ lbs.}$$

$$\text{SPA} = 0.47654912701 * \$29.21 * (103,932 / 100)$$

$$\text{SPA} = 0.47654912701 * \$29.21 * 1,039.32$$

SPA = \$14,467.33 Pay Adjustment to Contractor for Reinforced Concrete Deck Slab (Category 1) at Station 107+45.55 -L-

SCHEDULE OF ESTIMATED COMPLETION PROGRESS:

(7-15-08)(Rev. 6-17-25)

108-2

SP1 G58

The Contractor's attention is directed to the Standard Special Provision entitled *Availability of Funds Termination of Contracts* included elsewhere in this proposal. The Department of Transportation's schedule of estimated completion progress for this project as required by that Standard Special Provision is as follows:

	<u>Fiscal Year</u>	<u>Progress (% of Dollar Value)</u>
2026	(7/01/25 - 6/30/26)	5% of Total Amount Bid
2027	(7/01/26 - 6/30/27)	36% of Total Amount Bid
2028	(7/01/27 - 6/30/28)	33% of Total Amount Bid
2029	(7/01/28 - 6/30/29)	23% of Total Amount Bid
2030	(7/01/29 - 6/30/30)	3% of Total Amount Bid

The Contractor shall also furnish his own progress schedule in accordance with Article 108-2 of the *Standard Specifications*. Any acceleration of the progress as shown by the Contractor's progress schedule over the progress as shown above shall be subject to the approval of the Engineer.

MINORITY BUSINESS ENTERPRISE AND WOMEN BUSINESS ENTERPRISE:

(10-16-07)(Rev. 10-21-25)

102-15(J)

SP1 G66

Description

The purpose of this Special Provision is to carry out the North Carolina Department of Transportation's policy of ensuring nondiscrimination in the award and administration of contracts financed in whole or in part with State funds.

Definitions

Additional MBE/WBE Subcontractors - Any MBE/WBE submitted at the time of bid that will not be used to meet the Combined MBE /WBE Goal. No submittal of a Letter of Intent is required.

Combined MBE/WBE Goal: A portion of the total contract, expressed as a percentage that is to be performed by committed MBE/WBE subcontractors.

Committed MBE/WBE Subcontractor - Any MBE/WBE submitted at the time of bid that is being used to meet the Combined MBE /WBE goal by submission of a Letter of Intent. Or any MBE or WBE used as a replacement for a previously committed MBE or WBE firm.

Contract Goal Requirement - The approved participation at time of award, but not greater than the advertised Combined MBE/WBE contract goal.

Goal Confirmation Letter - Written documentation from the Department to the bidder confirming the Contractor's approved, committed participation along with a listing of the committed MBE and WBE firms.

Manufacturer - A firm that owns (or leases) and operates or maintains a factory or establishment that produces on the premises, the materials or supplies obtained by the Contractor. A firm that makes minor modifications to the materials, supplies, articles, or equipment is not a manufacturer.

MBE Participation (Anticipated) - A portion of the total contract, expressed as a percentage that is anticipated to be performed by committed MBE subcontractor(s).

Minority Business Enterprise (MBE) - A firm certified as a Disadvantaged Minority-Owned Business Enterprise through the North Carolina Unified Certification Program.

Regular Dealer - A firm that owns (or leases), and operates a store, warehouse, or other establishment in which the materials or supplies required for the performance of the contract are bought, kept in sufficient quantities, and regularly sold to the public in the usual course of business. A regular dealer engages in, as its principal business and in its own name, the purchase and sale or lease of the products in question. A regular dealer in such bulk items as steel, concrete or concrete products, gravel, stone, asphalt and petroleum products need not keep such products in stock, if it owns and operates distribution equipment for the products. Any supplement of regular dealers' own distribution equipment shall be by a long-term operating lease and not on an ad hoc or contract-by-contract basis.

Distributor - A firm that engages in the regular sale or lease of the items specified by the contract. A distributor assumes responsibility for the items it purchases once they leave the point of origin (e.g., a manufacturer's facility), making it liable for any loss or damage not covered by the carrier's insurance.

Replacement / Substitution - A full or partial reduction in the amount of work subcontracted to a committed (or an approved substitute) MBE/WBE firm.

North Carolina Unified Certification Program (NCUCP) - A program that provides comprehensive services and information to applicants for MBE/WBE certification. The MBE/WBE program follows the same regulations as the federal Disadvantaged Business Enterprise (DBE) program in accordance with 49 CFR Part 26.

United States Department of Transportation (USDOT) - Federal agency responsible for issuing regulations (49 CFR Part 26) and official guidance for the DBE program.

WBE Participation (Anticipated) - A portion of the total contract, expressed as a percentage, that is anticipated to be performed by committed WBE subcontractor(s).

Women Business Enterprise (WBE) - A firm certified as a Disadvantaged Women-Owned Business Enterprise through the North Carolina Unified Certification Program.

Forms and Websites Referenced in this Provision

Payment Tracking System - On-line system in which the Contractor enters the payments made to MBE and WBE subcontractors who have performed work on the project.
<https://apps.dot.state.nc.us/Vendor/PaymentTracking/>

DBE-IS Subcontractor Payment Information - Form for reporting the payments made to all MBE/WBE firms working on the project. This form is for paper bid projects only.
<https://connect.ncdot.gov/business/Turnpike/Documents/Form%20DBE-IS%20Subcontractor%20Payment%20Information.pdf>

RF-1 MBE/WBE Replacement Request Form - Form for replacing a committed MBE or WBE.
<https://connect.ncdot.gov/projects/construction/Construction%20Forms/DBE%20MBE%20WBE%20Replacement%20Form%20and%20Instructions.pdf>

SAF Subcontract Approval Form - Form required for approval to sublet the contract.
<https://connect.ncdot.gov/projects/construction/Construction%20Forms/SAF%20Form%20-%20Subcontract%20Approval%20Form%20Revised%2004-19.xlsm>

JC-1 Joint Check Notification Form - Form and procedures for joint check notification. The form acts as a written joint check agreement among the parties providing full and prompt disclosure of the expected use of joint checks.
<http://connect.ncdot.gov/projects/construction/Construction%20Forms/Joint%20Check%20Notification%20Form.pdf>

Letter of Intent - Form signed by the Contractor and the MBE/WBE subcontractor, manufacturer or regular dealer that affirms that a portion of said contract is going to be performed by the signed MBE/WBE for the estimated amount (based on quantities and unit prices) listed at the time of bid.
<http://connect.ncdot.gov/letting/LetCentral/Letter%20of%20Intent%20to%20Perform%20as%20a%20Subcontractor.pdf>

Listing of MBE and WBE Subcontractors Form - Form for entering MBE/WBE subcontractors on a project that will meet the Combined MBE/WBE goal. This form is for paper bids only.
[http://connect.ncdot.gov/municipalities/Bid%20Proposals%20for%20LGA%20Content/09%20MBE-WBE%20Subcontractors%20\(State\).docx](http://connect.ncdot.gov/municipalities/Bid%20Proposals%20for%20LGA%20Content/09%20MBE-WBE%20Subcontractors%20(State).docx)

Subcontractor Quote Comparison Sheet - Spreadsheet for showing all subcontractor quotes in the work areas where MBEs and WBEs quoted on the project. This sheet is submitted with good faith effort packages.
<http://connect.ncdot.gov/business/SmallBusiness/Documents/DBE%20Subcontractor%20Quote%20Comparison%20Example.xls>

DBE Regular Dealer/Distributor Affirmation Form – Form is used to make a preliminary counting determination for each DBE listed as a regular dealer or distributor to assess its eligibility for 60 or 40 percent credit, respectively of the cost of materials or supplies based on its demonstrated capacity and intent to perform as a regular dealer or distributor, as defined in section 49 CFR 26.55 under the contract at issue. A Contractor will submit the completed form with the Letter of Intent.
<https://connect.ncdot.gov/projects/construction/Construction%20Forms/DBE%20Regular%20Dealer-Distributor%20Affirmation%20Form%20-%20USDOT%202024.pdf>

Combined MBE/WBE Goal

There is NO MBE/WBE Goal for this project.

Directory of Transportation Firms (Directory)

Real-time information is available about firms doing business with the Department and firms that are certified through NCUCP in the Directory of Transportation Firms. Only firms identified in the Directory as MBE and WBE certified shall be used to meet the Combined MBE/WBE Goal. The Directory can be found at the following link.

<https://www.ebs.nc.gov/VendorDirectory/default.html>

The listing of an individual firm in the directory shall not be construed as an endorsement of the firm's capability to perform certain work.

Listing of MBE/WBE Subcontractors

At the time of bid, bidders shall submit all MBE and WBE participation that they anticipate to use during the life of the contract. Only those identified to meet the Combined MBE/WBE Goal will be considered committed, even though the listing shall include both committed MBE/WBE subcontractors and additional MBE/WBE subcontractors. Any additional MBE/WBE subcontractor participation above the goal will follow the banking guidelines found elsewhere in this provision. All other additional MBE/WBE subcontractor participation submitted at the time of bid will be used toward the Department's overall race-neutral goals. Only those firms with current MBE and WBE certification at the time of bid opening will be acceptable for listing in the bidder's submittal of MBE and WBE participation. The Contractor shall indicate the following required information:

(A) Electronic Bids

Bidders shall submit a listing of MBE and WBE participation in the appropriate section of the electronic submittal file.

- (1) Submit the names and addresses of MBE and WBE firms identified to participate in the contract. If the bidder uses the updated listing of MBE and WBE firms shown in the electronic submittal file, the bidder may use the dropdown menu to access the name and address of the firms.
- (2) Submit the contract line numbers of work to be performed by each MBE and WBE firm. When no figures or firms are entered, the bidder will be considered to have no MBE or WBE participation.
- (3) The bidder shall be responsible for ensuring that the MBE and WBE are certified at the time of bid by checking the Directory of Transportation Firms. If the firm is not certified at the time of the bid-letting, that MBE's or WBE's participation will not count towards achieving the Combined MBE/WBE goal.

(B) Paper Bids

- (1) *If the Combined MBE/WBE Goal is more than zero,*
 - (a) Bidders, at the time the bid proposal is submitted, shall submit a listing of MBE/WBE participation, including the names and addresses on *Listing of MBE and WBE Subcontractors* contained elsewhere in the contract documents in order for the bid to be considered responsive. Bidders shall indicate the total dollar value of the MBE and WBE participation for the contract.
 - (b) If bidders have no MBE or WBE participation, they shall indicate this on the *Listing of MBE and WBE Subcontractors* by entering the word “None” or the number “0.” This form shall be completed in its entirety. **Blank forms will not be deemed to represent zero participation.** Bids submitted that do not have MBE and WBE participation indicated on the appropriate form will not be read publicly during the opening of bids. The Department will not consider these bids for award and the proposal will be rejected.
 - (c) The bidder shall be responsible for ensuring that the MBE/WBE is certified at the time of bid by checking the Directory of Transportation Firms. If the firm is not certified at the time of the bid-letting, that MBE’s or WBE’s participation will not count towards achieving the Combined MBE/WBE Goal.
- (2) *If the Combined MBE/WBE Goal is zero,* entries on the *Listing of MBE and WBE Subcontractors* are not required for the zero goal, however any MBE or WBE participation that is achieved during the project shall be reported in accordance with requirements contained elsewhere in the special provision.

MBE or WBE Prime Contractor

When a certified MBE or WBE firm bids on a contract that contains a Combined MBE/WBE goal, the firm is responsible for meeting the goal or making good faith efforts to meet the goal, just like any other bidder. In most cases, a MBE or WBE bidder on a contract will meet the Combined MBE/WBE Goal by virtue of the work it performs on the contract with its own forces. However, all the work that is performed by the MBE or WBE bidder and any other similarly certified subcontractors will count toward the goal. The MBE or WBE bidder shall list itself along with any MBE or WBE subcontractors, if any, in order to receive credit toward the goal.

MBE/WBE prime contractors shall also follow Sections A and B listed under *Listing of MBE/WBE Subcontractor* just as a non-MBE/WBE bidder would.

Written Documentation – Letter of Intent

The bidder shall submit written documentation for each MBE/WBE that will be used to meet the Combined MBE/WBE Goal of the contract, indicating the bidder’s commitment to use the

MBE/WBE in the contract. This documentation shall be submitted on the Department's form titled *Letter of Intent*.

The documentation shall be received in the office of the State Contractor Utilization Engineer or at DBE@ncdot.gov no later than 10:00 a.m. of the sixth calendar day following opening of bids, unless the sixth day falls on an official state holiday. In that situation, it is due in the office of the State Contractor Utilization Engineer no later than 10:00 a.m. on the next official state business day.

If the bidder fails to submit the Letter of Intent from each committed MBE and WBE to be used toward the Combined MBE/WBE Goal, or if the form is incomplete (i.e. both signatures are not present), the MBE/WBE participation will not count toward meeting the Combined MBE/WBE Goal. If the lack of this participation drops the commitment below the Combined MBE/WBE Goal, the Contractor shall submit evidence of good faith efforts for the goal, completed in its entirety, to the State Contractor Utilization Engineer or DBE@ncdot.gov no later than 10:00 a.m. on the eighth calendar day following opening of bids, unless the eighth day falls on an official state holiday. In that situation, it is due in the office of the State Contractor Utilization Engineer no later than 10:00 a.m. on the next official state business day.

Banking MBE/WBE Credit

If the bid of the lowest responsive bidder exceeds \$500,000 and if the committed MBE/WBE participation submitted exceeds the algebraic sum of the Combined MBE /WBE Goal by \$1,000 or more, the excess will be placed on deposit by the Department for future use by the bidder. Separate accounts will be maintained for MBE and WBE participation and these may accumulate for a period not to exceed 24 months.

When the apparent lowest responsive bidder fails to submit sufficient participation by MBE and WBE firms to meet the advertised goal, as part of the good faith effort, the Department will consider allowing the bidder to withdraw funds to meet the Combined MBE/WBE Goal as long as there are adequate funds available from the bidder's MBE and WBE bank accounts.

Submission of Good Faith Effort

If the bidder fails to meet or exceed the Combined MBE/WBE Goal, the apparent lowest responsive bidder shall submit to the Department documentation of adequate good faith efforts made to reach that specific goal.

A hard copy and an electronic copy of this information shall be received in the office of the State Contractor Utilization Engineer or at DBE@ncdot.gov no later than 10:00 a.m. on the sixth calendar day following opening of bids unless the sixth day falls on an official state holiday. In that situation, it would be due in the office of the State Contractor Utilization Engineer no later than 10:00 a.m. on the next official state business day. If the Contractor cannot send the information electronically, then one complete set and 5 copies of this information shall be received under the same time constraints above.

Note: Where the information submitted includes repetitious solicitation letters, it will be acceptable to submit a representative letter along with a distribution list of the firms that were

solicited. Documentation of MBE/WBE quotations shall be a part of the good faith effort submittal. This documentation may include written subcontractor quotations, telephone log notations of verbal quotations, or other types of quotation documentation.

Consideration of Good Faith Effort for Projects with a Combined MBE/WBE Goal More Than Zero

Adequate good faith efforts mean that the bidder took all necessary and reasonable steps to achieve the goal which, by their scope, intensity, and appropriateness, could reasonably be expected to obtain sufficient MBE/WBE participation. Adequate good faith efforts also mean that the bidder actively and aggressively sought MBE/WBE participation. Mere *pro forma* efforts are not considered good faith efforts.

The Department will consider the quality, quantity, and intensity of the different kinds of efforts a bidder has made. Listed below are examples of the types of actions a bidder will take in making a good faith effort to meet the goals and are not intended to be exclusive or exhaustive, nor is it intended to be a mandatory checklist.

- (A) Soliciting through all reasonable and available means (e.g. attendance at pre-bid meetings, advertising, written notices, use of verifiable electronic means through the use of the NCDOT Directory of Transportation Firms) the interest of all certified MBEs/WBEs that are also prequalified subcontractors. The bidder must solicit this interest within at least 10 days prior to bid opening to allow the MBEs/WBEs to respond to the solicitation. Solicitation shall provide the opportunity to MBEs/WBEs within the Division and surrounding Divisions where the project is located. The bidder must determine with certainty if the MBEs/WBEs are interested by taking appropriate steps to follow up initial solicitations.
- (B) Selecting portions of the work to be performed by MBEs/WBEs in order to increase the likelihood that the Combined MBE/WBE Goal will be achieved.
 - (1) Where appropriate, break out contract work items into economically feasible units to facilitate MBE/WBE participation, even when the prime contractor might otherwise prefer to perform these work items with its own forces.
 - (2) Negotiate with subcontractors to assume part of the responsibility to meet the advertised goal when the work to be sublet includes potential for MBE/WBE participation (2nd and 3rd tier subcontractors).
- (C) Providing interested certified MBEs/WBEs that are also prequalified subcontractors with adequate information about the plans, specifications, and requirements of the contract in a timely manner to assist them in responding to a solicitation.
- (D)
 - (1) Negotiating in good faith with interested MBEs/WBEs. It is the bidder's responsibility to make a portion of the work available to MBE/WBE subcontractors and suppliers and to select those portions of the work or material needs consistent with the available MBE/WBE subcontractors and suppliers, so as to facilitate MBE/WBE participation. Evidence of such negotiation includes the

names, addresses, and telephone numbers of MBEs/WBEs that were considered; a description of the information provided regarding the plans and specifications for the work selected for subcontracting; and evidence as to why additional agreements could not be reached for MBEs/WBEs to perform the work.

- (2) A bidder using good business judgment would consider a number of factors in negotiating with subcontractors, including MBE/WBE subcontractors, and would take a firm's price and capabilities as well as the advertised goal into consideration. However, the fact that there may be some additional costs involved in finding and using MBEs/WBEs is not in itself sufficient reason for a bidder's failure to meet the contract goal, as long as such costs are reasonable. Also, the ability or desire of a prime contractor to perform the work of a contract with its own organization does not relieve the bidder of the responsibility to make good faith efforts. Bidding contractors are not, however, required to accept higher quotes from MBEs/WBEs if the price difference is excessive or unreasonable.
- (E) Not rejecting MBEs/WBEs as being unqualified without sound reasons based on a thorough investigation of their capabilities. The bidder's standing within its industry, membership in specific groups, organizations, or associates and political or social affiliations (for example, union vs. non-union employee status) are not legitimate causes for the rejection or non-solicitation of bids in the bidder's efforts to meet the project goal.
- (F) Making efforts to assist interested MBEs/WBEs in obtaining bonding, lines of credit, or insurance as required by the recipient or bidder.
- (G) Making efforts to assist interested MBEs/WBEs in obtaining necessary equipment, supplies, materials, or related assistance or services.
- (H) Effectively using the services of available minority/women community organizations; minority/women contractors' groups; Federal, State, and local minority/women business assistance offices; and other organizations as allowed on a case-by-case basis to provide assistance in the recruitment and placement of MBEs/WBEs. Contact within 7 days from the bid opening the Business Opportunity and Work Force Development Unit at BOWD@ncdot.gov to give notification of the bidder's inability to get MBE or WBE quotes.
- (I) Any other evidence that the bidder submits which shows that the bidder has made reasonable good faith efforts to meet the advertised goal.

In addition, the Department may take into account the following:

- (1) Whether the bidder's documentation reflects a clear and realistic plan for achieving the Combined MBE/WBE Goal.
- (2) The bidders' past performance in meeting the contract goal.

- (3) The performance of other bidders in meeting the advertised goal. For example, when the apparent successful bidder fails to meet the goal, but others meet it, you may reasonably raise the question of whether, with additional reasonable efforts the apparent successful bidder could have met the goal. If the apparent successful bidder fails to meet the advertised goal, but meets or exceeds the average MBE and WBE participation obtained by other bidders, the Department may view this, in conjunction with other factors, as evidence of the apparent successful bidder having made a good faith effort.

If the Department does not award the contract to the apparent lowest responsive bidder, the Department reserves the right to award the contract to the next lowest responsive bidder that can satisfy to the Department that the Combined MBE/WBE Goal can be met or that an adequate good faith effort has been made to meet the advertised goal.

Non-Good Faith Appeal

The State Prequalification Engineer will notify the Contractor verbally and in writing of non-good faith. A Contractor may appeal a determination of non-good faith made by the Goal Compliance Committee. If a Contractor wishes to appeal the determination made by the Committee, they shall provide written notification to the State Prequalification Engineer. The appeal shall be made within 2 business days of notification of the determination of non-good faith.

Counting MBE/WBE Participation Toward Meeting the Combined MBE/WBE Goal

(A) Participation

The total dollar value of the participation by a committed MBE/WBE will be counted toward the contract goal requirements. The total dollar value of participation by a committed MBE/WBE will be based upon the value of work performed by the MBE/WBE and the actual payments to MBE/WBE firms by the Contractor.

(B) Joint Checks

Prior notification of joint check use shall be required when counting MBE/WBE participation for services or purchases that involves the use of a joint check. Notification shall be through submission of Form JC-1 (*Joint Check Notification Form*) and the use of joint checks shall be in accordance with the Department's Joint Check Procedures.

(C) Subcontracts (Non-Trucking)

A MBE/WBE may enter into subcontracts. Work that a MBE subcontracts to another MBE firm may be counted toward the anticipated MBE participation. The same holds true for work that a WBE subcontracts to another WBE firm. Work that a MBE/WBE subcontracts to a non-MBE/WBE firm does not count toward the contract goal requirement. It should be noted that every effort shall be made by MBE and WBE contractors to subcontract to the same certification (i.e., MBEs to MBEs and WBEs to

WBEs), in order to fulfill the MBE or WBE participation breakdown. This, however, may not always be possible due to the limitation of firms in the area. If the MBE or WBE firm shows a good faith effort has been made to reach out to similarly certified firms and there is no interest or availability, and they can get assistance from other certified firms, the Engineer will not hold the prime responsible for meeting the individual MBE or WBE breakdown. If a MBE or WBE contractor or subcontractor subcontracts a significantly greater portion of the work of the contract than would be expected on the basis of standard industry practices, it shall be presumed that the MBE or WBE is not performing a commercially useful function.

(D) Joint Venture

When a MBE or WBE performs as a participant in a joint venture, the Contractor may count toward its contract goal requirement a portion of the total value of participation with the MBE or WBE in the joint venture, that portion of the total dollar value being a distinct clearly defined portion of work that the MBE or WBE performs with its forces.

(E) Manufacturer, Regular Dealer, Distributor

A Contractor may count toward its MBE/WBE requirement 40 percent of its expenditures for materials or supplies (including transportation costs) from a MBE/WBE distributor, 60 percent of its expenditures for materials or supplies (including transportation costs) from a MBE/WBE regular dealer and 100 percent of such expenditures obtained from a MBE/WBE manufacturer.

A Contractor may count toward its MBE/WBE requirement the following expenditures to MBE/WBE firms that are not manufacturers, regular dealers or distributors:

- (1) The fees or commissions charged by a MBE/WBE firm for providing a *bona fide* service, such as professional, technical, consultant, or managerial services, or for providing bonds or insurance specifically required for the performance of a DOT-assisted contract, provided the fees or commissions are determined to be reasonable and not excessive as compared with fees and commissions customarily allowed for similar services.
- (2) With respect to materials or supplies purchased from a MBE/WBE, which is neither a manufacturer, regular dealer, nor a distributor count the entire amount of fees or commissions charged that the Department deems to be reasonable, including transportation charges for the delivery of materials or supplies. Do not count any portion of the cost of the materials and supplies themselves.

A Contractor will submit a completed *DBE Regular Dealer/Distributor Affirmation Form* with the Letter of Intent to the State Contractor Utilization Engineer or DBE@ncdot.gov. The State Contractor Utilization Engineer will make a preliminary assessment as to whether a MBE/WBE supplier has the demonstrated capacity to perform a commercially useful function (CUF) on a contract-by-contract basis *prior* to its participation.

Commercially Useful Function**(A) MBE/WBE Utilization**

The Contractor may count toward its contract goal requirement only expenditures to MBEs and WBEs that perform a commercially useful function in the work of a contract. A MBE/WBE performs a commercially useful function when it is responsible for execution of the work of the contract and is carrying out its responsibilities by performing, managing, and supervising the work involved. To perform a commercially useful function, the MBE/WBE shall also be responsible with respect to materials and supplies used on the contract, for negotiating price, determining quality and quantity, ordering the material and installing (where applicable) and paying for the material itself. To determine whether a MBE/WBE is performing a commercially useful function, the Department will evaluate the amount of work subcontracted, industry practices, whether the amount the firm is to be paid under the contract is commensurate with the work it is performing and the MBE/WBE credit claimed for its performance of the work, and any other relevant factors. If it is determined that a MBE or WBE is not performing a Commercially Useful Function, the contractor may present evidence to rebut this presumption to the Department.

(B) MBE/WBE Utilization in Trucking

The following factors will be used to determine if a MBE or WBE trucking firm is performing a commercially useful function:

- (1) The MBE/WBE shall be responsible for the management and supervision of the entire trucking operation for which it is responsible on a particular contract, and there shall not be a contrived arrangement for the purpose of meeting the Combined MBE/WBE Goal.
- (2) The MBE/WBE shall itself own and operate at least one fully licensed, insured, and operational truck used on the contract.
- (3) The MBE/WBE receives credit for the total value of the transportation services it provides on the contract using trucks it owns, insures, and operates using drivers it employs.
- (4) The MBE may subcontract the work to another MBE firm, including an owner-operator who is certified as a MBE. The same holds true that a WBE may subcontract the work to another WBE firm, including an owner-operator who is certified as a WBE. When this occurs, the MBE or WBE who subcontracts work receives credit for the total value of the transportation services the subcontracted MBE or WBE provides on the contract. It should be noted that every effort shall be made by MBE and WBE contractors to subcontract to the same certification (i.e., MBEs to MBEs and WBEs to WBEs), in order to fulfill the participation breakdown. This, however, may not always be possible due to the limitation of firms in the area. If the MBE or WBE firm shows a good faith

effort has been made to reach out to similarly certified transportation service providers and there is no interest or availability, and they can get assistance from other certified providers, the Engineer will not hold the prime responsible for meeting the individual MBE or WBE participation breakdown.

- (5) The MBE/WBE may also subcontract the work to a non-MBE/WBE firm, including from an owner-operator. The MBE/WBE who subcontracts the work to a non-MBE/WBE is entitled to credit for the total value of transportation services provided by the non-MBE/WBE subcontractor not to exceed the value of transportation services provided by MBE/WBE-owned trucks on the contract. Additional participation by non-MBE/WBE subcontractors receives credit only for the fee or commission it receives as a result of the subcontract arrangement. The value of services performed under subcontract agreements between the MBE/WBE and the Contractor will not count towards the MBE/WBE contract requirement.
- (6) A MBE/WBE may lease truck(s) from an established equipment leasing business open to the general public. The lease must indicate that the MBE/WBE has exclusive use of and control over the truck. This requirement does not preclude the leased truck from working for others during the term of the lease with the consent of the MBE/WBE, so long as the lease gives the MBE/WBE absolute priority for use of the leased truck. This type of lease may count toward the MBE/WBE's credit as long as the driver is under the MBE/WBE's payroll.
- (7) Subcontracted/leased trucks shall display clearly on the dashboard the name of the MBE/WBE that they are subcontracted/leased to and their own company name if it is not identified on the truck itself. Magnetic door signs are not permitted.

MBE/WBE Replacement

When a Contractor has relied on a commitment to a MBE or WBE subcontractor (or an approved substitute MBE or WBE subcontractor) to meet all or part of a contract goal requirement, the contractor shall not terminate the MBE/WBE subcontractor or any portion of its work for convenience. This includes, but is not limited to, instances in which the Contractor seeks to perform the work of the terminated subcontractor with another MBE/WBE subcontractor, a non-MBE/WBE subcontractor, or with the Contractor's own forces or those of an affiliate.

The Contractor must give notice in writing both by certified mail and email to the MBE/WBE subcontractor, with a copy to the Engineer of its intent to request to terminate a MBE/WBE subcontractor or any portion of its work, and the reason for the request. The Contractor must give the MBE/WBE subcontractor five (5) business days to respond to the Contractor's Notice of Intent to Request Termination and/or Substitution. If the MBE/WBE subcontractor objects to the intended termination/substitution, the MBE/WBE, within five (5) business days must advise the Contractor and the Department of the reasons why the action should not be approved. The five-day notice period shall begin on the next business day after written notice is provided to the MBE/WBE subcontractor.

A committed MBE/WBE subcontractor may only be terminated or any portion of its work after receiving the Department's written approval based upon a finding of good cause for the proposed termination and/or substitution. Good cause does not exist if the Contractor seeks to terminate a MBE/WBE or any portion of its work that it relied upon to obtain the contract so that the Contractor can self-perform the work for which the MBE/WBE was engaged, or so that the Contractor can substitute another MBE/WBE or non-MBE/WBE contractor after contract award. For purposes of this section, good cause shall include the following circumstances:

- (a) The listed MBE/WBE subcontractor fails or refuses to execute a written contract;
- (b) The listed MBE/WBE subcontractor fails or refuses to perform the work of its subcontract in a way consistent with normal industry standards. Provided, however, that good cause does not exist if the failure or refusal of the MBE/WBE subcontractor to perform its work on the subcontract results from the bad faith or discriminatory action of the prime contractor;
- (c) The listed MBE/WBE subcontractor fails or refuses to meet the prime contractor's reasonable, nondiscriminatory bond requirements;
- (d) The listed MBE/WBE subcontractor becomes bankrupt, insolvent, or exhibits credit unworthiness;
- (e) The listed MBE/WBE subcontractor is ineligible to work on public works projects because of suspension and debarment proceedings pursuant to 2 CFR parts 180, 215 and 1200 or applicable State law;
- (f) The listed MBE/WBE subcontractor is not a responsible contractor;
- (g) The listed MBE/WBE voluntarily withdraws from the project and provides written notice of withdrawal;
- (h) The listed MBE/WBE is ineligible to receive MBE/WBE credit for the type of work required;
- (i) A MBE/WBE owner dies or becomes disabled with the result that the listed MBE/WBE contractor is unable to complete its work on the contract; and
- (j) Other documented good cause that compels the termination of the MBE/WBE subcontractor.

The Contractor shall comply with the following for replacement of a committed MBE/WBE:

(A) Performance Related Replacement

When a committed MBE/WBE is terminated for good cause as stated above, an additional MBE/WBE that was submitted at the time of bid may be used to fulfill the MBE/WBE commitment to meet the Combined MBE/WBE Goal. A good faith effort will only be required for removing a committed MBE/WBE if there were no additional MBE/WBEs submitted at the time of bid to cover the same amount of work as the MBE/WBE that was terminated.

If a replacement MBE/WBE is not found that can perform at least the same amount of work as the terminated MBE/WBE, the Contractor shall submit a good faith effort documenting the steps taken. Such documentation shall include, but not be limited to, the following:

- (1) Copies of written notification to MBE/WBEs that their interest is solicited in contracting the work defaulted by the previous MBE/WBE or in subcontracting other items of work in the contract.
 - (2) Efforts to negotiate with MBE/WBEs for specific subbids including, at a minimum:
 - (a) The names, addresses, and telephone numbers of MBE/WBEs who were contacted.
 - (b) A description of the information provided to MBE/WBEs regarding the plans and specifications for portions of the work to be performed.
 - (3) A list of reasons why MBE/WBE quotes were not accepted.
 - (4) Efforts made to assist the MBE/WBEs contacted, if needed, in obtaining bonding or insurance required by the Contractor.
- (B) Decertification Replacement
- (1) When a committed MBE/WBE is decertified by the Department after the SAF (*Subcontract Approval Form*) has been received by the Department, the Department will not require the Contractor to solicit replacement MBE/WBE participation equal to the remaining work to be performed by the decertified firm. The participation equal to the remaining work performed by the decertified firm will count toward the contract goal requirement but not the overall goal.
 - (i) If the MBE/WBE's ineligibility is caused solely by its having exceeded the size standard during the performance of the contract. The Department may continue to count participation equal to the remaining work performed by the decertified firm which will count toward the contract goal requirement and overall goal.
 - (ii) If the MBE/WBE's ineligibility is caused solely by its acquisition by or merger with a non- MBE/WBE during the performance of the contract. The Department may not continue to count the portion of the decertified firm's performance on the contract remaining toward either the contract goal or the overall goal, even if the Contractor has executed a subcontract with the firm or the Department has executed a prime contract with the MBE/WBE that was later decertified.
 - (2) When a committed MBE/WBE is decertified prior to the Department receiving the SAF (*Subcontract Approval Form*) for the named MBE/WBE firm, the

Contractor shall take all necessary and reasonable steps to replace the MBE/WBE subcontractor with another MBE/WBE subcontractor to perform at least the same amount of work to meet the Combined MBE/WBE goal requirement. If a MBE/WBE firm is not found to do the same amount of work, a good faith effort must be submitted to NCDOT (see A herein for required documentation).

All requests for replacement of a committed MBE/WBE firm shall be submitted to the Engineer for approval on Form RF-1 (*DBE Replacement Request*). If the Contractor fails to follow this procedure, the Contractor may be disqualified from further bidding for a period of up to 6 months.

Changes in the Work

When the Engineer makes changes that result in the reduction or elimination of work to be performed by a committed MBE/WBE, the Contractor will not be required to seek additional participation. When the Engineer makes changes that result in additional work to be performed by a MBE/WBE based upon the Contractor's commitment, the MBE/WBE shall participate in additional work to the same extent as the MBE/WBE participated in the original contract work.

When the Engineer makes changes that result in extra work, which has more than a minimal impact on the contract amount, the Contractor shall seek additional participation by MBEs/WBEs unless otherwise approved by the Engineer.

When the Engineer makes changes that result in an alteration of plans or details of construction, and a portion or all of the work had been expected to be performed by a committed MBE/WBE, the Contractor shall seek participation by MBEs/WBEs unless otherwise approved by the Engineer.

When the Contractor requests changes in the work that result in the reduction or elimination of work that the Contractor committed to be performed by a MBE/WBE, the Contractor shall seek additional participation by MBEs/WBEs equal to the reduced MBE/WBE participation caused by the changes.

Reports and Documentation

A SAF (*Subcontract Approval Form*) shall be submitted for all work which is to be performed by a MBE/WBE subcontractor. The Department reserves the right to require copies of actual subcontract agreements involving MBE/WBE subcontractors.

When using transportation services to meet the contract commitment, the Contractor shall submit a proposed trucking plan in addition to the SAF. The plan shall be submitted prior to beginning construction on the project. The plan shall include the names of all trucking firms proposed for use, their certification type(s), the number of trucks owned by the firm, as well as the individual truck identification numbers, and the line item(s) being performed.

Within 30 calendar days of entering into an agreement with a MBE/WBE for materials, supplies or services, not otherwise documented by the SAF as specified above, the Contractor shall

furnish the Engineer a copy of the agreement. The documentation shall also indicate the percentage (60% or 100%) of expenditures claimed for MBE/WBE credit.

Reporting Minority and Women Business Enterprise Participation

The Contractor shall provide the Engineer with an accounting of payments made to all MBE/WBE firms, including material suppliers and contractors at all levels (prime, subcontractor, or second tier subcontractor). This accounting shall be furnished to the Engineer for any given month by the end of the following month. Failure to submit this information accordingly may result in the following action:

- (A) Withholding of money due in the next partial pay estimate; or
- (B) Removal of an approved contractor from the prequalified bidders' list or the removal of other entities from the approved subcontractors list.

While each contractor (prime, subcontractor, 2nd tier subcontractor) is responsible for accurate accounting of payments to MBEs/WBEs, it shall be the prime contractor's responsibility to report all monthly and final payment information in the correct reporting manner.

Failure on the part of the Contractor to submit the required information in the time frame specified may result in the disqualification of that contractor and any affiliate companies from further bidding until the required information is submitted.

Failure on the part of any subcontractor to submit the required information in the time frame specified may result in the disqualification of that contractor and any affiliate companies from being approved for work on future DOT projects until the required information is submitted.

Contractors reporting transportation services provided by non-MBE/WBE lessees shall evaluate the value of services provided during the month of the reporting period only.

At any time, the Engineer can request written verification of subcontractor payments.

The Contractor shall report the accounting of payments through the Department's Payment Tracking System.

Failure to Meet Contract Requirements

Failure to meet contract requirements in accordance with Subarticle 102-15(J) of the *Standard Specifications* may be cause to disqualify the Contractor.

RESTRICTIONS ON ITS EQUIPMENT AND SERVICES:

(11-17-20)

SP01 G090

All telecommunications, video or other ITS equipment or services installed or utilized on this project must be in conformance with UNIFORM ADMINISTRATIVE REQUIREMENTS, COST PRINCIPLES, AND AUDIT REQUIREMENTS FOR FEDERAL AWARDS **2 CFR, § 200.216 Prohibition on certain telecommunications and video surveillance services or equipment.**

USE OF UNMANNED AIRCRAFT SYSTEM (UAS):

(8-20-19)(Rev. 8-19-25)

SP1 G092

The Contractor shall adhere to all Federal, State and Local regulations and guidelines for the use of Unmanned Aircraft Systems (UAS). This includes but is not limited to US 14 CFR Part 107, NC GS 15A-300, all FAA rules, regulations and policies and all NCDOT UAS Policies. The required operator certifications include possessing a current Federal Aviation Administration (FAA) Remote Pilot Certificate, as well as operating a UAS registered with the FAA.

All UAS operations shall be approved by the Engineer prior to beginning the operations.

All contractors or subcontractors operating UAS shall have UAS specific general liability insurance to cover all operations under this contract.

The use of UAS is at the Contractor's discretion. No measurement or payment will be made for the use of UAS. In the event that the Department directs the Contractor to utilize UAS, payment will be in accordance with Article 104-7 Extra Work.

EQUIPMENT IDLING GUIDELINES:

(1-19-21)

107

SP1 G096

Exercise reduced fuel consumption and reduced equipment emissions during the construction of all work associated with this contract. Employees engaged in the construction of this project should turn off vehicles when stopped for more than thirty (30) minutes and off-highway equipment should idle no longer than fifteen (15) consecutive minutes.

These guidelines for turning off vehicles and equipment when idling do not apply to:

1. Idling when queuing.
2. Idling to verify the vehicle is in safe operating condition.
3. Idling for testing, servicing, repairing or diagnostic purposes.
4. Idling necessary to accomplish work for which the vehicle was designed (such as operating a crane, mixing concrete, etc.).
5. Idling required to bring the machine system to operating temperature.
6. Emergency vehicles, utility company, construction, and maintenance vehicles where the engines must run to perform needed work.
7. Idling to ensure safe operation of the vehicle.
8. Idling when the propulsion engine is providing auxiliary power for other than heating or air conditioning. (such as hydraulic systems for pavers)

9. When specific traffic, safety, or emergency situations arise.
10. If the ambient temperature is less than 32 degrees Fahrenheit. Limited idling to provide for the safety of vehicle occupants (e.g. to run the heater).
11. If the ambient temperature is greater than 90 degrees Fahrenheit. Limited idling to provide for the safety of vehicle occupants of off-highway equipment (e.g. to run the air conditioning) no more than 30 minutes.
12. Diesel powered vehicles may idle for up to 30 minutes to minimize restart problems.

Any vehicle, truck, or equipment in which the primary source of fuel is natural gas or electricity is exempt from the idling limitations set forth in this special provision.

SUBSURFACE INFORMATION:

(7-1-95)

450

SP1 G112 C

Subsurface information is available on the roadway and structure portions of this project.

MAINTENANCE OF THE PROJECT:

(11-20-07)(Rev. 1-16-24)

104-10

SP1 G125

Revise the *Standard Specifications* as follows:

Page 1-35, Article 104-10 Maintenance of the Project, line 3, add the following after the first sentence of the first paragraph:

All guardrail/guiderail within the project limits shall be included in this maintenance.

Page 1-35, Article 104-10 MAINTENANCE OF THE PROJECT, line 8, add the following as the last sentence of the first paragraph:

The Contractor shall perform weekly inspections of guardrail and guiderail and shall report damages to the Engineer on the same day of the weekly inspection. *Where damaged guardrail or guiderail is repaired or replaced as a result of maintaining the project in accordance with this article, such repair or replacement shall be performed within 7 consecutive calendar days of such inspection report.*

Page 1-35, Article 104-10 MAINTENANCE OF THE PROJECT, lines 20-22, replace the last sentence of the last paragraph with the following:

The Contractor will not be directly compensated for any maintenance operations necessary, except for maintenance of guardrail/guiderail, as this work will be considered incidental to the work covered by the various contract items. The provisions of Article 104-7, Extra Work, and Article 104-8, Compensation and Record Keeping will apply to authorized maintenance of guardrail/guiderail. Performance of weekly inspections of guardrail/guiderail, and the damage reports required as described above, will be considered to be an incidental part of the work being paid for by the various contract items.

COOPERATION BETWEEN CONTRACTORS:

(7-1-95)(Rev. 1-16-24)

105-7

SPI G133

The Contractor's attention is directed to Article 105-7 of the *Standard Specifications*.

U-5724 (C204540) is located in the vicinity of this project. U-5724 is currently under construction and not anticipated to be completed prior to the letting of this project.

The Contractor on this project shall cooperate with the Contractor working within or adjacent to the limits of this project to the extent that the work can be carried out to the best advantage of all concerned.

TWELVE MONTH GUARANTEE:

(7-15-03)

108

SPI G145

- (A) The Contractor shall guarantee materials and workmanship against latent and patent defects arising from faulty materials, faulty workmanship or negligence for a period of twelve months following the date of final acceptance of the work for maintenance and shall replace such defective materials and workmanship without cost to the Department. The Contractor will not be responsible for damage due to faulty design, normal wear and tear, for negligence on the part of the Department, and/or for use in excess of the design.
- (B) Where items of equipment or material carry a manufacturer's guarantee for any period in excess of twelve months, then the manufacturer's guarantee shall apply for that particular piece of equipment or material. The Department's first remedy shall be through the manufacturer although the Contractor is responsible for invoking the warranted repair work with the manufacturer. The Contractor's responsibility shall be limited to the term of the manufacturer's guarantee. NCDOT would be afforded the same warranty as provided by the Manufacturer.

This guarantee provision shall be invoked only for major components of work in which the Contractor would be wholly responsible for under the terms of the contract. Examples would include pavement structures, bridge components, and sign structures. This provision will not be used as a mechanism to force the Contractor to return to the project to make repairs or perform additional work that the Department would normally compensate the Contractor for. In addition, routine maintenance activities (i.e. mowing grass, debris removal, ruts in earth shoulders,) are not parts of this guarantee.

Appropriate provisions of the payment and/or performance bonds shall cover this guarantee for the project.

To ensure uniform application statewide the Division Engineer will forward details regarding the circumstances surrounding any proposed guarantee repairs to the Chief Engineer for review and approval prior to the work being performed.

OUTSOURCING OUTSIDE THE USA:

(9-21-04) (Rev. 5-16-06)

SPI G150

All work on consultant contracts, services contracts, and construction contracts shall be performed in the United States of America. No work shall be outsourced outside of the United States of America.

Outsourcing for the purpose of this provision is defined as the practice of subcontracting labor, work, services, staffing, or personnel to entities located outside of the United States.

The North Carolina Secretary of Transportation shall approve exceptions to this provision in writing.

EROSION AND SEDIMENT CONTROL/STORMWATER CERTIFICATION:

(1-16-07) (Rev. 10-15-24)

105-16, 225-2, 16

SPI G180

General

Schedule and conduct construction activities in a manner that will minimize soil erosion and the resulting sedimentation and turbidity of surface waters. Comply with the requirements herein regardless of whether or not a National Pollution discharge Elimination System (NPDES) permit for the work is required.

Establish a chain of responsibility for operations and subcontractors' operations to ensure that the *Erosion and Sediment Control/Stormwater Pollution Prevention Plan* is implemented and maintained over the life of the contract.

- (A) *Certified Supervisor* - Provide a certified Erosion and Sediment Control/Stormwater Supervisor to manage the Contractor and subcontractor operations, insure compliance with Federal, State and Local ordinances and regulations, and manage the Quality Control Program.
- (B) *Certified Foreman* - Provide a certified, trained foreman for each construction operation that increases the potential for soil erosion or the possible sedimentation and turbidity of surface waters.
- (C) *Certified Installer* - Provide a certified installer to install or direct the installation for erosion or sediment/stormwater control practices.
- (D) *Certified Designer* - Provide a certified designer for the design of the erosion and sediment control/stormwater component of reclamation plans and, if applicable, for the design of the project erosion and sediment control/stormwater plan.

Roles and Responsibilities

- (A) *Certified Erosion and Sediment Control/Stormwater Supervisor* - The Certified Supervisor shall be Level II and responsible for ensuring the erosion and sediment control/stormwater plan is adequately implemented and maintained on the project and for conducting the quality control program. The Certified Supervisor shall be on the project

within 24 hours notice from initial exposure of an erodible surface to the project's final acceptance. Perform the following duties:

- (1) Manage Operations - Coordinate and schedule the work of subcontractors so that erosion and sediment control/stormwater measures are fully executed for each operation and in a timely manner over the duration of the contract.
 - (a) Oversee the work of subcontractors so that appropriate erosion and sediment control/stormwater preventive measures are conformed to at each stage of the work.
 - (b) Prepare the required National Pollutant Discharge Elimination System (NPDES) Inspection Record and submit to the Engineer.
 - (c) Attend all weekly or monthly construction meetings to discuss the findings of the NPDES inspection and other related issues.
 - (d) Implement the erosion and sediment control/stormwater site plans requested.
 - (e) Provide any needed erosion and sediment control/stormwater practices for the Contractor's temporary work not shown on the plans, such as, but not limited to work platforms, temporary construction, pumping operations, plant and storage yards, and cofferdams.
 - (f) Acquire applicable permits and comply with requirements for borrow pits, dewatering, and any temporary work conducted by the Contractor in jurisdictional areas.
 - (g) Conduct all erosion and sediment control/stormwater work in a timely and workmanlike manner.
 - (h) Fully perform and install erosion and sediment control/stormwater work prior to any suspension of the work.
 - (i) Coordinate with Department, Federal, State and Local Regulatory agencies on resolution of erosion and sediment control/stormwater issues due to the Contractor's operations.
 - (j) Ensure that proper cleanup occurs from vehicle tracking on paved surfaces or any location where sediment leaves the Right-of-Way.
 - (k) Have available a set of erosion and sediment control/stormwater plans that are initialed and include the installation date of Best Management Practices. These practices shall include temporary and permanent groundcover and be properly updated to reflect necessary plan and field changes for use and review by Department personnel as well as regulatory agencies.

- (2) Requirements set forth under the NPDES Permit - The Department's NPDES Stormwater permit (NCS000250) outlines certain objectives and management measures pertaining to construction activities. The permit references *NCG010000, General Permit to Discharge Stormwater* under the NPDES, and states that the Department shall incorporate the applicable requirements into its delegated Erosion and Sediment Control Program for construction activities disturbing one or more acres of land. The Department further incorporates these requirements on all contracted bridge and culvert work at jurisdictional waters, regardless of size. Some of the requirements are, but are not limited to:

- (a) Control project site waste to prevent contamination of surface or ground waters of the state, i.e. from equipment operation/maintenance, construction materials, concrete washout, chemicals, litter, fuels, lubricants, coolants, hydraulic fluids, any other petroleum products, and sanitary waste.
 - (b) Inspect erosion and sediment control/stormwater devices and stormwater discharge outfalls at least once every 7 calendar days and within 24 hours after a rainfall event equal to or greater than 1.0 inch that occurs within a 24 hour period. Additional monitoring may be required at the discretion of Division of Water Resources personnel if the receiving stream is 303(d) listed for turbidity and the project has had documented problems managing turbidity.
 - (c) Maintain an onsite rain gauge or use the Department's Multi-Sensor Precipitation Estimate website to maintain a daily record of rainfall amounts and dates.
 - (d) Maintain erosion and sediment control/stormwater inspection records for review by Department and Regulatory personnel upon request.
 - (e) Implement approved reclamation plans on all borrow pits, waste sites and staging areas.
 - (f) Maintain a log of turbidity test results as outlined in the Department's Procedure for Monitoring Borrow Pit Discharge.
 - (g) Provide secondary containment for bulk storage of liquid materials.
 - (h) Provide training for employees concerning general erosion and sediment control/stormwater awareness, the Department's NPDES Stormwater Permit NCS000250 requirements, and the applicable requirements of the *General Permit, NCG010000*.
 - (i) Report violations of the NPDES permit to the Engineer immediately who will notify the Division of Water Quality Regional Office within 24 hours of becoming aware of the violation.
- (3) Quality Control Program - Maintain a quality control program to control erosion, prevent sedimentation and follow provisions/conditions of permits. The quality control program shall:
- (a) Follow permit requirements related to the Contractor and subcontractors' construction activities.
 - (b) Ensure that all operators and subcontractors on site have the proper erosion and sediment control/stormwater certification.
 - (c) Notify the Engineer when the required certified erosion and sediment control/stormwater personnel are not available on the job site when needed.
 - (d) Conduct the inspections required by the NPDES permit.
 - (e) Take corrective actions in the proper timeframe as required by the NPDES permit for problem areas identified during the NPDES inspections.
 - (f) Incorporate erosion control into the work in a timely manner and stabilize disturbed areas with mulch/seed or vegetative cover on a section-by-section basis.

- (g) Use flocculants approved by state regulatory authorities where appropriate and where required for turbidity and sedimentation reduction.
 - (h) Ensure proper installation and maintenance of temporary erosion and sediment control devices.
 - (i) Remove temporary erosion or sediment control devices when they are no longer necessary as agreed upon by the Engineer.
 - (j) The Contractor's quality control and inspection procedures shall be subject to review by the Engineer. Maintain NPDES inspection records and make records available at all times for verification by the Engineer.
- (B) *Certified Foreman* - At least one Certified Foreman shall be onsite for each type of work listed herein during the respective construction activities to control erosion, prevent sedimentation and follow permit provisions:
- (1) Foreman in charge of grading activities
 - (2) Foreman in charge of bridge or culvert construction over jurisdictional areas
 - (3) Foreman in charge of utility activities

The Contractor may request to use the same person as the Level II Supervisor and Level II Foreman. This person shall be onsite whenever construction activities as described above are taking place. This request shall be approved by the Engineer prior to work beginning.

The Contractor may request to name a single Level II Foreman to oversee multiple construction activities on small bridge or culvert replacement projects. This request shall be approved by the Engineer prior to work beginning.

- (C) *Certified Installers* - Provide at least one onsite, Level I Certified Installer for each of the following erosion and sediment control/stormwater crew:
- (1) Seeding and Mulching
 - (2) Temporary Seeding
 - (3) Temporary Mulching
 - (4) Sodding
 - (5) Silt fence or other perimeter erosion/sediment control device installations
 - (6) Erosion control blanket installation
 - (7) Hydraulic tackifier installation
 - (8) Turbidity curtain installation
 - (9) Rock ditch check/sediment dam installation
 - (10) Ditch liner/matting installation
 - (11) Inlet protection
 - (12) Riprap placement
 - (13) Stormwater BMP installations (such as but not limited to level spreaders, retention/detention devices)
 - (14) Pipe installations within jurisdictional areas

If a Level I *Certified Installer* is not onsite, the Contractor may substitute a Level II Foreman for a Level I Installer, provided the Level II Foreman is not tasked to another crew requiring Level II Foreman oversight.

- (D) *Certified Designer* - Include the certification number of the Level III Certified Designer on the erosion and sediment control/stormwater component of all reclamation plans and if applicable, the certification number of the Level III Certified Designer on the design of the project erosion and sediment control/stormwater plan.

Preconstruction Meeting

Furnish the names of the *Certified Erosion and Sediment Control/Stormwater Supervisor*, *Certified Foremen*, *Certified Installers* and *Certified Designer* and notify the Engineer of changes in certified personnel over the life of the contract within 2 days of change.

Ethical Responsibility

Any company performing work for the North Carolina Department of Transportation has the ethical responsibility to fully disclose any reprimand or dismissal of an employee resulting from improper testing or falsification of records.

Revocation or Suspension of Certification

Upon recommendation of the Chief Engineer to the certification entity, certification for *Supervisor*, *Certified Foremen*, *Certified Installers* and *Certified Designer* may be revoked or suspended with the issuance of an *Immediate Corrective Action (ICA)*, *Notice of Violation (NOV)*, or *Cease and Desist Order* for erosion and sediment control/stormwater related issues.

The Chief Engineer may recommend suspension or permanent revocation of certification due to the following:

- (A) Failure to adequately perform the duties as defined within this certification provision.
- (B) Issuance of an ICA, NOV, or Cease and Desist Order.
- (C) Failure to fully perform environmental commitments as detailed within the permit conditions and specifications.
- (D) Demonstration of erroneous documentation or reporting techniques.
- (E) Cheating or copying another candidate's work on an examination.
- (F) Intentional falsification of records.
- (G) Directing a subordinate under direct or indirect supervision to perform any of the above actions.
- (H) Dismissal from a company for any of the above reasons.
- (I) Suspension or revocation of one's certification by another entity.

Suspension or revocation of a certification will be sent by certified mail to the certificant and the Corporate Head of the company that employs the certificant.

A certificant has the right to appeal any adverse action which results in suspension or permanent revocation of certification by responding, in writing, to the Chief Engineer within 10 calendar days after receiving notice of the proposed adverse action.

Chief Engineer
1536 Mail Service Center
Raleigh, NC 27699-1536

Failure to appeal within 10 calendar days will result in the proposed adverse action becoming effective on the date specified on the certified notice. Failure to appeal within the time specified will result in a waiver of all future appeal rights regarding the adverse action taken. The certificant will not be allowed to perform duties associated with the certification during the appeal process.

The Chief Engineer will hear the appeal and make a decision within 7 days of hearing the appeal. Decision of the Chief Engineer will be final and will be made in writing to the certificant.

If a certification is temporarily suspended, the certificant shall pass any applicable written examination and any proficiency examination, at the conclusion of the specified suspension period, prior to having the certification reinstated.

Measurement and Payment

All work described within this provision and the role of Certified Erosion and Sediment Control/Stormwater Supervisor, Certified Foremen, Certified Installers and Certified Designer will be incidental to the project for which no direct compensation will be made.

PROCEDURE FOR MONITORING BORROW PIT DISCHARGE:

(2-20-07) (Rev. 1-16-24)

105-16, 230, 801

SP1 G181

Water discharge from borrow pit sites shall not cause surface waters to exceed 50 NTUs (nephelometric turbidity unit) in streams not designated as trout waters and 10 NTUs in streams, lakes or reservoirs designated as trout waters. For lakes and reservoirs not designated as trout waters, the turbidity shall not exceed 25 NTUs. If the turbidity exceeds these levels due to natural background conditions, the existing turbidity level shall not be increased.

If during any operating day, the downstream water quality exceeds the standard, the Contractor shall do all of the following:

- (A) Either cease discharge or modify the discharge volume or turbidity levels to bring the downstream turbidity levels into compliance, or
- (B) Evaluate the upstream conditions to determine if the exceedance of the standard is due to natural background conditions. If the background turbidity measurements exceed the standard, operation of the pit and discharge can continue as long as the stream turbidity levels are not increased due to the discharge.

- (C) Measure and record the turbidity test results (time, date and sampler) at all defined sampling locations 30 minutes after startup and at a minimum, one additional sampling of all sampling locations during that 24-hour period in which the borrow pit is discharging.
- (D) Notify DWQ within 24 hours of any stream turbidity standard exceedances that are not brought into compliance.

During the Environmental Assessment required by Article 230-4 of the *Standard Specifications*, the Contractor shall define the point at which the discharge enters into the State's surface waters and the appropriate sampling locations. Sampling locations shall include points upstream and downstream from the point at which the discharge enters these waters. Upstream sampling location shall be located so that it is not influenced by backwater conditions and represents natural background conditions. Downstream sampling location shall be located at the point where complete mixing of the discharge and receiving water has occurred.

The discharge shall be closely monitored when water from the dewatering activities is introduced into jurisdictional wetlands. Any time visible sedimentation (deposition of sediment) on the wetland surface is observed, the dewatering activity will be suspended until turbidity levels in the stilling basin can be reduced to a level where sediment deposition does not occur. Staining of wetland surfaces from suspended clay particles, occurring after evaporation or infiltration, does not constitute sedimentation. No activities shall occur in wetlands that adversely affect the functioning of a wetland. Visible sedimentation will be considered an indication of possible adverse impacts on wetland use.

The Engineer will perform independent turbidity tests on a random basis. These results will be maintained in a log within the project records. Records will include, at a minimum, turbidity test results, time, date and name of sampler. Should the Department's test results exceed those of the Contractor's test results, an immediate test shall be performed jointly with the results superseding the previous test results of both the Department and the Contractor.

The Contractor shall use the *NCDOT Turbidity Reduction Options for Borrow Pits Matrix*, available at <https://connect.ncdot.gov/resources/roadside/FieldOperationsDocuments/TurbidityReductionOptionSheet.pdf> to plan, design, construct, and maintain BMPs to address water quality standards. Tier I Methods include stilling basins which are standard compensatory BMPs. Other Tier I methods are noncompensatory and shall be used when needed to meet the stream turbidity standards. Tier II Methods are also noncompensatory and are options that may be needed for protection of rare or unique resources or where special environmental conditions exist at the site which have led to additional requirements being placed in the DWQ's 401 Certifications and approval letters, Isolated Wetland Permits, Riparian Buffer Authorization or a DOT Reclamation Plan's Environmental Assessment for the specific site. Should the Contractor exhaust all Tier I Methods on a site exclusive of rare or unique resources or special environmental conditions, Tier II Methods may be required by regulators on a case by case basis per supplemental agreement.

The Contractor may use cation exchange capacity (CEC) values from proposed site borings to plan and develop the bid for the project. CEC values exceeding 15 milliequivalents per 100 grams of soil may indicate a high potential for turbidity and should be avoided when dewatering into surface water is proposed.

No additional compensation for monitoring borrow pit discharge will be paid.

NOTE TO CONTRACTOR:

If dead bats are observed during clearing, demolition, or any construction related activities, the contractor shall immediately notify the Engineer, who will then inform the Division Environmental Officer (DEO). The DEO will collect and preserve the bats for identification. If the DEO suspects dead bats of being NLEB or TCB, such bats will be placed in a freezer until coordination can be made with the USFWS Raleigh Field Office to arrange transfer.

PROJECT SPECIAL PROVISIONS**ROADWAY****CLEARING AND GRUBBING - METHOD III:**

(4-6-06)(Rev. 3-19-24)

200

SP2 R02B

Perform clearing on this project to the limits established by Method - III shown on Standard Drawing No. 200.03 of the *Roadway Standard Drawings*. Conventional clearing methods may be used except where permit drawings or conditions have been included in the proposal which require certain areas to be cleared by hand methods.

BUILDING REMOVAL:

(1-1-02)(Rev. 1-16-24)

215

SP2 R15 D

Remove the buildings, underground storage tanks and appurtenances listed below in accordance with Section 215 of the *Standard Specifications*:

Building Removal No. 1 / Parcel 103

Description: 1 Story Metal Commercial Building

Right of Survey Station 101+50 to S.S. 103+75, SL-L-

When the description of the work for an item indicates a building partially inside and partially outside the right of way and/or construction area, but does not require the building to be cut off, the entire building shall be removed. This paragraph pertains to Building Removal No. 1.

LUMP SUM GRADING:

(8-17-10)(Rev. 1-16-24)

226

SP2 R16

Lump sum grading shall be performed in accordance with Section 226 Comprehensive Grading of the *Standard Specifications* except as follows:

Delete all references to **Section 230 Borrow Excavation (Item 0106)**.

SHOULDER AND FILL SLOPE MATERIAL:

(5-21-02)(Rev. 1-16-24)

235, 560

SP2 R45 A

Description

Perform the required shoulder and slope construction for this project in accordance with the applicable requirements of Section 560 and Section 235 of the *Standard Specifications*.

Measurement and Payment

Where the material has been obtained from an authorized stockpile or from a borrow source and *Borrow Excavation* is not included in the contract, no direct payment will be made for this work, as the cost of this work will be part of the work being paid at the contract lump sum price for *Grading*. If *Borrow Excavation* is included in this contract and the material has been obtained from an authorized stockpile or from a borrow source, measurement and payment will be as provided in Section 230 of the *Standard Specifications for Borrow Excavation*.

BORROW EXCAVATION (In Place or Truck Measurement):

(7-1-95)(Rev. 1-16-24)

230

SP2 R58

The borrow material used on this project will be measured for payment by in place measurement as provided in Article 230-5 of the *Standard Specifications*, or by truck measurement as provided in Article 230-5 of the *Standard Specifications*, as directed by the Engineer.

MANUFACTURED QUARRY FINES IN EMBANKMENTS:

(01-17-17)(Rev. 4-16-24)

235

SP02 R72

Description

This specification addresses the use of manufactured quarry fines that are not classified as select materials. The specification allows the Contractor an option, with the approval of the Engineer, to use manufactured quarry fines (MQFs) in embankments as a substitute for conventional borrow material. Furnish and place geotextile for subgrade stabilization in accordance with the contract. Geotextile for subgrade stabilization is required to prevent pavement cracking and provide separation between the subgrade and pavement section at embankment locations where manufactured quarry fines are utilized and as directed by the Engineer.

Materials

Manufactured Quarry Fines.

Site specific approval of MQFs material will be required prior to beginning construction as detailed in the preconstruction requirements of this provision.

The following MQFs are unacceptable:

- (A) Frozen material,
- (B) Material with a maximum dry unit weight of less than 90 pounds per cubic foot when tested in accordance with AASHTO T 99 Method A or C.
- (C) Material with greater than 80% by weight Passing the #200 sieve

Collect and transport MQFs in a manner that will prevent nuisances and hazards to public health and safety. Moisture condition the MQFs as needed and transport in covered trucks to prevent dusting. If MQFs are blended with natural earth material, follow Borrow Criteria in Section 1018 of the *Standard Specifications*.

Preconstruction Requirements

When MQFs are to be used as a substitute for earth borrow material, request written approval from the Engineer at least ninety (90) days in advance of the intent to use MQFs and include the following details:

- (A) Description, purpose and location of project.
- (B) Estimated start and completion dates of project.
- (C) Estimated volume of MQFs to be used on project with specific locations and construction details of the placement.
- (D) The names, address, and contact information for the generator of the MQFs.
- (E) Physical location of the site at which the MQFs were generated.

The Engineer will forward this information to the State Materials Engineer for review and material approval.

Construction Methods

Place MQFs in the core of the embankment section with at least 4 feet of earth cover to the outside limits of the embankments or subgrade.

Construct embankments by placing MQFs in level uniform lifts with no more than a lift of 10 inches and compacted to at least a density of 95 percent as determined by test methods in AASHTO T 99, Determination of Maximum Dry Density and Optimum Moisture Content, Method A or C depending upon particle size of the product. Provide a moisture content at the time of compaction of within 4 percent of optimum but not greater than one percent above optimum as determined by AASHTO T 99, Method A or C.

In embankments where MQFs are incorporated, geotextile for subgrade stabilization shall be used. Refer to Article 505-2 of the *Standard Specifications* for geotextile type and Article 505-3 of the *Standard Specifications* for the geotextile construction methods.

Measurement and Payment

Borrow Excavation will be measured by truck volume and paid in cubic yards in accordance with Article 230-5 of the *Standard Specifications*. As an alternate weigh tickets can be provided and payment made by converting weight to cubic yards based on the verifiable unit weight. Where the pay item for *Borrow Excavation* is not included in the original contract then no separate payment will be made for this item and payment will be included in the lump sum price bid for *Grading*.

Geotextile for Subgrade Stabilization will be measured and paid in accordance with Article 505-4 of the *Standard Specifications*. When the pay item for *Geotextile for Subgrade Stabilization* is

not included in the original contract then no payment will be made for this item and will be considered incidental to the use of MQFs in embankment.

FLOWABLE FILL:

(9-17-02) (Rev. 1-16-24)

300, 340, 1000, 1530, 1540, 1550

SP3 R30

Description

This work consists of all work necessary to place flowable fill in accordance with these provisions, the plans, and as directed.

Materials

Refer to Division 10 of the *Standard Specifications*.

Item

Flowable Fill

Section

1000-7

Construction Methods

Discharge flowable fill material directly from the truck into the space to be filled, or by other approved methods. The mix may be placed full depth or in lifts as site conditions dictate. The Contractor shall provide a method to plug the ends of the existing pipe in order to contain the flowable fill.

Measurement and Payment

At locations where flowable fill is called for on the plans and a pay item for flowable fill is included in the contract, *Flowable Fill* will be measured in cubic yards and paid as the actual number of cubic yards that have been satisfactorily placed and accepted. Such price and payment will be full compensation for all work covered by this provision including, but not limited to, the mix design, furnishing, hauling, placing and containing the flowable fill.

Payment will be made under:

Pay Item

Flowable Fill

Pay Unit

Cubic Yard

CORRUGATED ALUMINUM ALLOY CULVERT PIPE:

(9-21-21)(Rev. 1-16-24)

305, 310

SP3 R34

Revise the *Standard Specifications* as follows:

Page 3-5, Article 305-2, MATERIALS, add the following after line 16:

Item

Waterborne Paint

Hot Bitumen

Section

1080-9

1081-3

Page 3-5, Article 305-3, CONSTRUCTION METHODS, add the following after line 26:

Coating must be applied to the aluminum when in contact with concrete. Immediately prior to coating, aluminum surfaces to be coated shall be cleaned by a method that will remove all dirt, oil, grease, chips, and other foreign substances. Aluminum to be coated shall be given one coat of suitable quality coating such as:

Approved waterborne paint (Section 1080-9)

Approved Hot Bitumen (Section 1081-3)

Other coating materials may be submitted to the Engineer for approval.

Page 3-7, Article 310-6, MEASUREMENT AND PAYMENT, lines 10-11, delete the fourth sentence and replace with the following:

Select bedding and backfill material and coating will be included in the cost of the installed pipe.

STABILIZATION OF COASTAL PLAIN SANDS:

(11-18-14)

510

SP5 R12

Description

As directed by the Engineer, stabilize sandy subgrade material with Class IV aggregate to prevent rutting of the subgrade prior to paving directly on the subgrade. Remove material as needed in cut areas prior to placing the Class IV aggregate.

Materials

Refer to Division 10.

Item

Select Material, Class IV

Section

1016

Use Class IV Select Material for Class IV Aggregate Stabilization.

Construction Methods

Class IV Aggregate Stabilization

As directed by the Engineer, place aggregate by end dumping aggregate on approved subgrade soils to provide a working platform and reduce wheel rutting of subgrade material. Place the Class IV aggregate stabilization to a thickness of 2 to 3 inches.

Maintenance

Maintain aggregate stabilization in an acceptable condition and minimize the use of heavy equipment on aggregate in order to avoid damaging the subgrade. Provide and maintain drainage ditches and drains as required to prevent entrapping water in aggregate stabilization.

Measurement and Payment

Class IV Aggregate Stabilization will be measured and paid in tons. Aggregate will be measured by weighing in trucks in accordance with Article 106-7. The contract unit price for *Class IV Aggregate Stabilization* will be full compensation for furnishing, hauling, handling, placing, mixing, compacting and maintaining aggregate.

The work to excavate material to place Class IV Aggregate Stabilization below subgrade is considered incidental to the work of placing the aggregate and no separate payment will be made.

Payment will be made under:

Pay Item	Pay Unit
Class IV Aggregate Stabilization	Ton

PRICE ADJUSTMENT - ASPHALT BINDER FOR PLANT MIX:

(11-21-00)(Rev. 1-16-24)

620

SP6 R25

Price adjustments for asphalt binder for plant mix will be made in accordance with Section 620 of the *Standard Specifications*.

The base price index for asphalt binder for plant mix is \$ **552.50** per ton.

This base price index represents an average of F.O.B. selling prices of asphalt binder at supplier's terminals on **January 1, 2026**.

FINAL SURFACE TESTING REQUIRED:

(1-20-25)

610

SP6 R045B

Perform final surface testing in accordance with Article 610-13 of the *Standard Specifications* in areas that meet the criteria outlined in Article 610-13 of the *Standard Specifications* or otherwise delineated in the contract.

FINAL SURFACE TESTING ASPHALT PAVEMENT:

(11-18-25)

610

SP6 R048

Revise the *Standard Specifications* as follows:

Page 6-24, Article 610-13 FINAL SURFACE TESTING AND ACCEPTANCE, line 35, delete the last sentence of the first paragraph of the Article and replace with the following:

Final surface testing is not required on SR-designated routes, on any alignment where the speed limit is less than 45 mph, on roundabouts, ramps, loops and turn lanes, or where the paving limits are less than one mile in length.

JOINT REPAIR:**Description**

The Contractor's attention is directed to the Joint Repair Detail in the plans. Joint repair is required at various locations throughout the project limits as directed by the Engineer. This work shall consist of sawing or milling the joint, removal of existing asphalt and concrete, cleaning the joint, and placing Asphalt Concrete Base Course, Type B25.0C in the cleaned joint. Work shall be done in accordance with the Joint Repair Detail in the plans and the applicable requirements of the *Standard Specifications*.

Method of Measurement

Joint Repair will be based on the actual tonnage required of **Asphalt Concrete Base Course, Type B25.0C and/or Asphalt Concrete Intermediate Course, Type I19.0C** to fill each joint.

Basis of Payment

Joint Repair will be paid for at the contract unit price per ton for "*Joint Repair*".

Payment for joint repair will be made only in areas that have been examined and approved by the Engineer or his designated representative.

The unit price shown in the contract shall be full compensation for all material, labor, tools, equipment, maintenance of traffic, and all other incidentals necessary to complete the work.

Payment will be made under:

Pay Item	Pay Unit
Joint Repair	Ton

DETECTABLE WARNING SURFACE AT CURB RAMPS:

(8-19-25)

848

SP8 R52A

Description

Install detectable warning surface at curb ramps as shown in the plans or as directed by the Engineer, in accordance with Section 848 of the *Standard Specifications* and this special provision.

Materials

Detectable warning surface materials shall consist of raised truncated domes found on the NCDOT APL, meet the requirements of Article 848-2 of the *Standard Specifications* and be capable of being affixed to or anchored in the concrete sidewalk, including green concrete defined as concrete that has set but not appreciably hardened, cured concrete, or asphalt pavement. Surface applied such as glued or stick down applications are prohibited for permanent installations unless approved by the Engineer.

The detectable warning surface shall be uniform in color and texture, be free of cracks or other defects. The color shall be an approximate visual match to the color specified in the contract or as approved by the Engineer.

Construction Methods

Install all detectable warning surface in accordance with the manufacturer's recommendations, Article 848-3 of the *Standard Specifications* and as approved by the Engineer. Ensure the surface is free of debris and irregularities prior to placing the detectable warning on the surface. Place in fresh concrete, before the concrete has reached initial set, or on a hardened cement concrete surface or asphalt pavement surface. Secure permanent installations with mechanical fasteners. No cutting of the coated colored truncated domes is allowed. Embossing or stamping the wet concrete to achieve the truncated dome pattern or using a mold into which a catalyst-hardened material is applied is not allowed. Detectable warning surfaces shall be 24 inches in the direction of travel and extend the full width of the flush surface. The detectable warning surface shall show no appreciable fading, lifting or shrinkage and fit contours, breaks and faults of concrete and asphalt surfaces and show no significant tearing, rollback, lifting or other signs of poor adhesion.

Remove and replace any damaged or misaligned detectable warning surfaces and repair any damage to adjacent facilities prior to final acceptance at no cost to the Department. The finished installation shall meet all applicable ADA and Public Right-of-Way Accessibility Guidelines (PROWAG) requirements for placement, orientation, surface condition, and visual contrast.

Measurement and Payment

The detectable warning surface at curb ramps are incidental to *Concrete Curb Ramps, Retrofit Existing Curb Ramps, and/or Remove and Replace Curb Ramps* in accordance with Article 848-4 of the *Standard Specifications*.

FOUNDATIONS AND ANCHOR ROD ASSEMBLIES FOR METAL POLES:

(1-17-12)(Rev. 1-16-24)

9, 14, 17

SP9 R05

Description

Foundations for metal poles include foundations for signals, cameras, overhead and dynamic message signs (DMS) and high mount and light standards supported by metal poles or upright trusses. Foundations consist of footings with pedestals and drilled piers with or without grade beams or wings. Anchor rod assemblies consist of anchor rods (also called anchor bolts) with nuts and washers on the exposed ends of rods and nuts and a plate or washers on the other ends of rods embedded in the foundation.

Construct concrete foundations with the required resistances and dimensions and install anchor rod assemblies in accordance with the contract and accepted submittals. Construct drilled piers consisting of cast-in-place reinforced concrete cylindrical sections in excavated holes. Provide temporary casings or polymer slurry as needed to stabilize drilled pier excavations. Use a prequalified Drilled Pier Contractor to construct drilled piers for metal poles. Define "excavation" and "hole" as a drilled pier excavation and "pier" as a drilled pier.

This provision does not apply to foundations for signal pedestals; see Section 1743 of the *Standard Specifications* and Roadway Standard Drawing No. 1743.01.

Materials

Refer to the *Standard Specifications*.

Item	Section
Conduit	1091-3
Grout, Type 2	1003
Polymer Slurry	411-2(B)(2)
Portland Cement Concrete	1000
Reinforcing Steel	1070
Rollers and Chairs	411-2(C)
Temporary Casings	411-2(A)

Provide Type 3 material certifications in accordance with Article 106-3 of the *Standard Specifications* for conduit, rollers, chairs and anchor rod assemblies. Store steel materials on blocking at least 12" above the ground and protect it at all times from damage; and when placing in the work make sure it is free from dirt, dust, loose mill scale, loose rust, paint, oil or other foreign materials. Load, transport, unload and store foundation and anchor rod assembly materials so materials are kept clean and free of damage. Bent, damaged or defective materials will be rejected.

Use conduit type in accordance with the contract. Use Class A concrete for footings and pedestals, Class Drilled Pier concrete for drilled piers and Class AA concrete for grade beams and wings including portions of drilled piers above bottom of wings elevations. Corrugated temporary casings may be accepted at the discretion of the Engineer. A list of approved polymer slurry products is available from:

connect.ncdot.gov/resources/Geological/Pages/Products.aspx

Provide anchor rod assemblies in accordance with the contract consisting of the following:

- (A) Straight anchor rods,
- (B) Heavy hex top and leveling nuts and flat washers on exposed ends of rods, and
- (C) Nuts and either flat plates or washers on the other ends of anchor rods embedded in foundations.

Do not use lock washers. Use steel anchor rods, nuts and washers that meet ASTM F1554 for Grade 55 rods and Grade A nuts. Use steel plates and washers embedded in concrete with a thickness of at least 1/4". Galvanize anchor rods and exposed nuts and washers in accordance with Article 1076-4 of the *Standard Specifications*. It is not necessary to galvanize nuts, plates and washers embedded in concrete.

Construction Methods

Install the required size and number of conduits in foundations in accordance with the plans and accepted submittals. Construct top of piers, footings, pedestals, grade beams and wings flat, level and within 1" of elevations shown in the plans or approved by the Engineer. Provide an Ordinary Surface finish in accordance with Subarticle 825-6(B) of the *Standard Specifications* for portions of foundations exposed above finished grade. Do not remove anchor bolt templates or pedestal or grade beam forms or erect metal poles or upright trusses onto foundations until concrete attains a compressive strength of at least 3,000 psi.

(A) Drilled Piers

Before starting drilled pier construction, hold a predrill meeting to discuss the installation, monitoring and inspection of the drilled piers. Schedule this meeting after the Drilled Pier Contractor has mobilized to the site. The Resident or Division Traffic Engineer, Contractor and Drilled Pier Contractor Superintendent will attend this predrill meeting.

Do not excavate holes, install piles or allow equipment wheel loads or vibrations within 20 ft of completed piers until 16 hours after Drilled Pier concrete reaches initial set.

Check for correct drilled pier alignment and location before beginning drilling. Check plumbness of holes frequently during drilling.

Construct drilled piers with the minimum required diameters shown in the plans. Install piers with tip elevations no higher than shown in the plans or approved by the Engineer.

Excavate holes with equipment of the sizes required to construct drilled piers. Depending on the subsurface conditions encountered, drilling through rock and boulders may be required. Do not use blasting for drilled pier excavations.

Contain and dispose of drilling spoils and waste concrete as directed and in accordance with Section 802 of the *Standard Specifications*. Drilling spoils consist of all materials and fluids removed from excavations.

If unstable, caving or sloughing materials are anticipated or encountered, stabilize holes with temporary casings and/or polymer slurry. Do not use telescoping temporary casings. If it becomes necessary to replace a temporary casing during drilling, backfill the excavation, insert a larger casing around the casing to be replaced or stabilize the excavation with polymer slurry before removing the temporary casing.

If temporary casings become stuck or the Contractor proposes leaving casings in place, temporary casings should be installed against undisturbed material. Unless otherwise approved, do not leave temporary casings in place for mast arm poles and cantilever signs. The Engineer will determine if casings may remain in place. If the Contractor proposes leaving temporary casings in place, do not begin drilling until a casing installation method is approved.

Use polymer slurry and additives to stabilize holes in accordance with the slurry manufacturer's recommendations. Provide mixing water and equipment suitable for polymer slurry. Maintain the required slurry properties at all times except for sand content.

Define a "sample set" as slurry samples collected from mid-height and within 2 ft of the bottom of holes. Take sample sets from excavations to test polymer slurry immediately after filling holes with slurry, at least every 4 hours thereafter and immediately before placing concrete. Do not place Drilled Pier concrete until both slurry samples from an excavation meet the required polymer slurry properties. If any slurry test results do not meet the requirements, the Engineer may suspend drilling until both samples from a sample set meet the required polymer slurry properties.

Remove soft and loose material from bottom of holes using augers to the satisfaction of the Engineer. Assemble rebar cages and place cages and Drilled Pier concrete in accordance with Subarticle 411-4(E) of the *Standard Specifications* except for the following:

- (1) Inspections for tip resistance and bottom cleanliness are not required,
- (2) Temporary casings may remain in place if approved, and
- (3) Concrete placement may be paused near the top of pier elevations for anchor rod assembly installation and conduit placement or
- (4) If applicable, concrete placement may be stopped at bottom of grade beam or wings elevations for grade beam or wing construction.

If wet placement of concrete is anticipated or encountered, do not place Drilled Pier concrete until a concrete placement procedure is approved. If applicable, temporary casings and fluids may be removed when concrete placement is paused or stopped in accordance with the exceptions above provided holes are stable. Remove contaminated concrete from exposed Drilled Pier concrete after removing casings and fluids. If holes are unstable, do not remove temporary casings until a procedure for placing anchor rod assemblies and conduit or constructing grade beams or wings is approved.

Use collars to extend drilled piers above finished grade. Remove collars after Drilled Pier concrete sets and round top edges of piers.

If drilled piers are questionable, pile integrity testing (PIT) and further investigation may be required in accordance with Article 411-5 of the *Standard Specifications*. A drilled pier will be considered defective in accordance with Subarticle 411-5(D) of the *Standard Specifications* and drilled pier acceptance is based in part on the criteria in Article 411-6 of the *Standard Specifications* except for the top of pier tolerances in Subarticle 411-6(C) of the *Standard Specifications*.

If a drilled pier is under further investigation, do not grout core holes, backfill around the pier or perform any work on the drilled pier until the Engineer accepts the pier. If the drilled pier is accepted, dewater and grout core holes and backfill around the pier with approved material to finished grade. If the Engineer determines a pier is unacceptable,

remediation is required in accordance with Article 411-6 of the *Standard Specifications*. No extension of completion date or time will be allowed for remediation of unacceptable drilled piers or post repair testing.

Permanently embed a plate in or mark top of piers with the pier diameter and depth, size and number of vertical reinforcing bars and the minimum compressive strength of the concrete mix at 28 days.

(B) Footings, Pedestals, Grade Beams and Wings

Excavate as necessary for footings, grade beams and wings in accordance with the plans, accepted submittals and Section 410 of the *Standard Specifications*. If unstable, caving or sloughing materials are anticipated or encountered, shore foundation excavations as needed with an approved method. Notify the Engineer when foundation excavation is complete. Do not place concrete or reinforcing steel until excavation dimensions and foundation material are approved.

Construct cast-in-place reinforced concrete footings, pedestals, grade beams and wings with the dimensions shown in the plans and in accordance with Section 825 of the *Standard Specifications*. Use forms to construct portions of pedestals and grade beams protruding above finished grade. Provide a chamfer with a 3/4" horizontal width for pedestal and grade beam edges exposed above finished grade. Place concrete against undisturbed soil or backfill and fill in accordance with Article 410-8 of the *Standard Specifications*. Proper compaction around footings and wings is critical for foundations to resist uplift and torsion forces.

(C) Anchor Rod Assemblies

Size anchor rods for design and the required projection above top of foundations. Determine required anchor rod projections from nut, washer and base plate thicknesses, the protrusion of 3 to 5 anchor rod threads above top nuts after tightening and the distance of one nut thickness between top of foundations and bottom of leveling nuts.

Protect anchor rod threads from damage during storage and installation of anchor rod assemblies. Before placing anchor rods in foundations, turn nuts onto and off rods past leveling nut locations. Turn nuts with the effort of one workman using an ordinary wrench without a cheater bar. Report any thread damage to the Engineer that requires extra effort to turn nuts.

Arrange anchor rods symmetrically about center of base plate locations as shown in the plans. Set anchor rod elevations based on required projections above top of foundations. Securely brace and hold rods in the correct position, orientation and alignment with a steel template. Do not weld to reinforcing steel, temporary casings or anchor rods.

Install top and leveling (bottom) nuts, washers and the base plate for each anchor rod assembly in accordance with the following procedure:

- (1) Turn leveling nuts onto anchor rods to a distance of one nut thickness between the top of foundation and bottom of leveling nuts. Place washers over anchor rods on top of leveling nuts.
- (2) Determine if nuts are level using a flat rigid template on top of washers. If necessary, lower leveling nuts to level the template in all directions or if applicable, lower nuts to tilt the template so the metal pole or upright truss will lean as shown in the plans. If leveling nuts and washers are not in full contact with the template, replace washers with galvanized beveled washers.
- (3) Verify the distance between the foundation and leveling nuts is no more than one nut thickness.
- (4) Place base plate with metal pole or upright truss over anchor rods on top of washers. High mount luminaires may be attached before erecting metal poles but do not attach cables, mast arms or trusses to metal poles or upright trusses at this time.
- (5) Place washers over anchor rods on top of base plate. Lubricate top nut bearing surfaces and exposed anchor rod threads above washers with beeswax, paraffin or other approved lubricant.
- (6) Turn top nuts onto anchor rods. If nuts are not in full contact with washers or washers are not in full contact with the base plate, replace washers with galvanized beveled washers.
- (7) Tighten top nuts to snug-tight with the full effort of one workman using a 12" wrench. Do not tighten any nut all at once. Turn top nuts in increments. Follow a star pattern cycling through each nut at least twice.
- (8) Repeat (7) for leveling nuts.
- (9) Replace washers above and below the base plate with galvanized beveled washers if the slope of any base plate face exceeds 1:20 (5%), any washer is not in firm contact with the base plate or any nut is not in firm contact with a washer. If any washers are replaced, repeat (7) and (8).
- (10) With top and leveling nuts snug-tight, mark each top nut on a corner at the intersection of 2 flats and a corresponding reference mark on the base plate. Mark top nuts and base plate with ink or paint that is not water-soluble. Use the turn-of-nut method for pretensioning. Do not pretension any nut all at once. Turn top nuts in increments for a total turn that meets the following nut rotation requirements:

NUT ROTATION REQUIREMENTS (Turn-of-Nut Pretensioning Method)	
Anchor Rod Diameter, inch	Requirement
$\leq 1 \frac{1}{2}$	1/3 turn (2 flats)
$> 1 \frac{1}{2}$	1/6 turn (1 flat)

Follow a star pattern cycling through each top nut at least twice.

- (11) Ensure nuts, washers and base plate are in firm contact with each other for each anchor rod. Cables, mast arms and trusses may now be attached to metal poles and upright trusses.
- (12) Between 4 and 14 days after pretensioning top nuts, use a torque wrench

calibrated within the last 12 months to check nuts in the presence of the Engineer. Completely erect mast arm poles and cantilever signs and attach any hardware before checking top nuts for these structures. Check that top nuts meet the following torque requirements:

TORQUE REQUIREMENTS	
Anchor Rod Diameter, inch	Requirement, ft-lb
7/8	180
1	270
1 1/8	380
1 1/4	420
≥ 1 1/2	600

If necessary, retighten top nuts in the presence of the Engineer with a calibrated torque wrench to within ± 10 ft-lb of the required torque. Do not overtighten top nuts.

- (13) Do not grout under base plate.

Measurement and Payment

Foundations and anchor rod assemblies for metal poles and upright trusses will be measured and paid for elsewhere in the contract.

No payment will be made for temporary casings that remain in drilled pier excavations. No payment will be made for PIT. No payment will be made for further investigation of defective piers. Further investigation of piers that are not defective will be paid as extra work in accordance with Article 104-7 of the *Standard Specifications*. No payment will be made for remediation of unacceptable drilled piers or post repair testing.

HIGH STRENGTH CONCRETE FOR DRIVEWAYS:

(11-21-00)(Rev. 1-16-24)

848

SP10 R02

Use high early strength concrete for all driveways shown in the plans and as directed by the Engineer. Provide high early strength concrete that meets the requirements of Article 1000-6 of the *Standard Specifications*.

Measurement and payment will be in accordance with Section 848 of the *Standard Specifications*.

ELECTRONIC TICKETING SYSTEM:

(7-16-24)(Rev. 12-17-24)

1020

SP10 R20

Description

At the contractor's option, the use of an electronic ticketing system for reporting individual and cumulative asphalt material deliveries may be utilized on this project. At the preconstruction conference, the contractor shall notify the Engineer if they intend to utilize an electronic ticketing system for reporting individual and cumulative asphalt material deliveries to the project.

Electronic Ticketing Requirements

- a. The electronic ticketing system must be fully integrated with the load read-out system at the plant. The system shall be designed so data inputs from scales cannot be altered by either the Contractor or the Department.
- b. Material supplier must test to confirm that ticketing data can be shared from the originating system no less than 30 days prior to project start.
- c. After each truck is loaded, ticket data must be electronically captured, and ticket information uploaded via Application Programming Interface (API) to the Department.
- d. Obtain security token from NCDOT for access to E-Ticketing portal (to send tickets). To request a Security Key, fill out the below E-Ticketing Security Request Form: <https://forms.office.com/g/XnT7QeRtgt>
- e. Obtain API from NCDOT containing the required e-ticketing data fields and format. Download the API from the NCDOT E-ticketing Webpage: <https://connect.ncdot.gov/projects/construction/E-Ticketing/Pages/default.aspx>
- f. Provide all ticket information in real time and daily summaries to the Department's designated web portal. If the project contains locations with limited cellular service, an alternative course of action must be agreed upon.
- g. Electronic ticketing submissions must be sent between the Material Supplier and the Department.
- h. The electronic ticket shall contain the following information:

Date
Contract Number
Supplier Name
Contractor Name
Material
JMF
Gross Weight
Tare Weight
Net Weight
Load Number
Cumulative Weight
Truck Number
Weighmaster Certification
Weighmaster Expiration
Weighmaster Name
Facility Name
Plant Certification Number
Ticket Number

Hauling Firm (optional)
 Voided Ticket Number (if necessary)
 Original Ticket Number (if necessary)
 Supplier Revision (If necessary)

The Contractor/supplier can use the electronic ticketing system of their choice to meet the requirements of this provision.

Measurement and Payment

No measurement or payment will be made for utilizing an electronic ticketing system as the cost of such shall be included in the contract price bid for the material being provided.

GLASS BEAD GRADATION FOR PAVEMENT MARKINGS:

(9-17-24)

1087

SP10 R87

Revise the *Standard Specifications* as follows:

Page 10-187, Subarticle 1087-4(C), Gradation & Roundness, after line 6, delete and replace Table 1087-2 with the following:

TABLE 1087-2		
GLASS BEAD GRADATION REQUIREMENTS		
Sieve Size	Gradation Requirements	
	Minimum	Maximum
Passing #20	100%	--
Retained on #30	5%	15%
Retained on #50	40%	80%
Retained on #80	15%	40%
Passing #80	0%	10%
Retained on #200	0%	5%

TEMPORARY SHORING:

(2-20-07)(Rev. 1-16-24)

SP11 R02

Description

Temporary shoring includes cantilever, braced and anchored shoring and temporary mechanically stabilized earth (MSE) walls. Temporary shoring does not include trench boxes. At the Contractor’s option, use any type of temporary shoring unless noted otherwise in the plans or as directed. Design and construct temporary shoring based on actual elevations and shoring dimensions in accordance with the contract and accepted submittals. Construct temporary shoring at locations shown in the plans and as directed. Temporary shoring is required to maintain traffic when a 2:1 (H:V) slope from the top of an embankment or bottom of an excavation will intersect the existing ground line less than 5 feet from the edge of pavement of an open travelway. This provision does not apply to pipe, inlet or utility installation unless noted otherwise in the plans.

Positive protection includes concrete barrier and temporary guardrail. Provide positive protection for temporary shoring at locations shown in the plans and as directed. Positive

protection is required if temporary shoring is located in the clear zone in accordance with the *AASHTO Roadside Design Guide*.

(A) Cantilever and Braced Shoring

Cantilever shoring consists of steel sheet piles or H-piles with timber lagging. Braced shoring consists of sheet piles or H-piles with timber lagging and bracing such as beams, plates, walers, struts, rakers, etc. Define “piles” as sheet piles or H-piles.

(B) Anchored Shoring

Anchored shoring consists of sheet piles with walers or H-piles with timber lagging anchored with ground or helical anchors. Driven anchors may be accepted at the discretion of the Engineer. A ground anchor consists of a grouted steel bar or multi-strand tendon with an anchorage. A helical anchor consists of a lead section with a central steel shaft and at least one helix steel plate followed by extensions with only central shafts (no helixes) and an anchorage. Anchorages consist of steel bearing plates with washers and hex nuts for bars or steel wedge plates and wedges for strands. Use a prequalified Anchored Wall Contractor to install ground anchors. Define “anchors” as ground, helical or driven anchors.

(C) Temporary MSE Walls

Temporary MSE walls include temporary geosynthetic and wire walls. Define “temporary wall” as a temporary MSE wall and “Temporary Wall Vendor” as the vendor supplying the temporary MSE wall. Define “reinforcement” as geotextile, geogrid, geostrip, welded wire grid or metallic strip reinforcement.

Temporary geosynthetic walls consist of geotextiles or geogrids wrapped behind welded wire facing or geostrips connected to welded wire facing. Define “temporary geotextile wall” as a temporary geosynthetic wall with geotextile reinforcement, “temporary geogrid wall” as a temporary geosynthetic wall with geogrid reinforcement and “temporary geostrip wall” as a temporary geosynthetic wall with geostrip reinforcement.

Temporary wire walls consist of welded wire grid or metallic strip reinforcement connected to welded wire facing. Define “Wire Wall Vendor” as the vendor supplying the temporary wire wall.

(D) Embedment

Define “embedment” for cantilever, braced and anchored shoring as the pile depth below the grade in front of shoring. Define “embedment” for temporary walls as the wall embedment below the grade at the wall face.

(E) Positive Protection

Define “unanchored or anchored portable concrete barrier” as portable concrete barrier (PCB) that meets *Roadway Standard Drawing* No. 1170.01. Define “concrete barrier” as

unanchored or anchored PCB or an approved equal. Define “temporary guardrail” as temporary steel beam guardrail that meets *Roadway Standard Drawing* No. 862.02.

Materials

Refer to the *Standard Specifications*.

Item	Section
Concrete Barrier Materials	1170-2
Flowable Fill, Excavatable	1000-7
Geosynthetics	1056
Grout, Type 1	1003
Portland Cement	1024-1
Portland Cement Concrete	1000
Select Materials	1016
Steel Beam Guardrail Materials	862-2
Steel Plates	1072-2
Steel Sheet Piles and H-Piles	1084
Untreated Timber	1082-2
Water	1024-4
Welded Wire Reinforcement	1070-3

Provide Type 6 material certifications for shoring materials in accordance with Article 106-3 of the *Standard Specifications*. Use Class IV select material for temporary guardrail and Class A concrete that meets Article 450-2 of the *Standard Specifications* or Type 1 grout for drilled-in piles. Provide untreated timber with a thickness of at least 3 inches and a bending stress of at least 1,000 pounds per square inch for timber lagging. Provide steel bracing that meets ASTM A36.

(A) Shoring Backfill

Use Class II, Type 1, Class III, Class V or Class VI select material or material that meets AASHTO M 145 for soil classification A-2-4 with a maximum PI of 6 for shoring backfill except do not use A-2-4 soil for backfill around culverts.

(B) Anchors

Store anchor materials on blocking a minimum of 12 inches above the ground and protect it at all times from damage; and when placing in the work make sure it is free from dirt, dust, loose mill scale, loose rust, paint, oil or other foreign materials. Load, transport, unload and store anchor materials so materials are kept clean and free of damage. Bent, damaged or defective materials will be rejected.

(1) Ground Anchors

Use high-strength deformed steel bars that meet AASHTO M 275 or seven-wire strands that meet ASTM A886 or Article 1070-5 of the *Standard Specifications*. Splice bars in accordance with Article 1070-9 of the *Standard Specifications*.

Do not splice strands. Use bondbreakers, spacers and centralizers that meet Article 6.3.5 of the *AASHTO LRFD Bridge Construction Specifications*.

Use neat cement grout that only contains cement and water with a water cement ratio of 0.4 to 0.5 which is approximately 5.5 gallons of water per 94 pounds of Portland cement. Provide grout with a compressive strength at 3 and 28 days of at least 1,500 and 4,000 psi, respectively.

(2) Helical Anchors

Use helical anchors with an ICC Evaluation Service, Inc. (ICC-ES) report. Provide couplers, thread bar adapters and bolts recommended by the Anchor Manufacturer to connect helical anchors together and to piles.

(3) Anchorages

Provide steel plates for bearing plates and steel washers, hex nuts, wedge plates and wedges recommended by the Anchor Manufacturer.

(C) Temporary Walls

(1) Welded Wire Facing

Use welded wire reinforcement for welded wire facing, struts and wires. For temporary wire walls, provide welded wire facing supplied by the Wire Wall Vendor or a manufacturer approved or licensed by the vendor. For temporary wire walls with separate reinforcement and facing components, provide connectors (e.g., bars, clamps, plates, etc.) and fasteners (e.g., bolts, nuts, washers, etc.) required by the Wire Wall Vendor.

(2) Geotextiles

Provide Type 2 geotextile for separation and retention geotextiles. Provide Type 5a geotextile for geotextile reinforcement with ultimate tensile strengths in accordance with the accepted submittals.

(3) Geogrid and Geostrip Reinforcement

Use geogrids with a roll width of at least 4 feet. Use geogrids for geogrid reinforcement and geostrips for geostrip reinforcement with an “approved” status code in accordance with the NCDOT Geosynthetic Reinforcement Evaluation Program. The list of approved geogrids and geostrips is available from: connect.ncdot.gov/resources/Geological/Pages/Products.aspx

Provide geogrids and geostrips with design strengths in accordance with the accepted submittals. Geogrids and geostrips are approved for short-term design strengths (3-year design life) in the machine direction (MD) and cross-machine direction (CD) based on material type. Define material type from the website

above for shoring backfill as follows:

Material Type	Shoring Backfill
Borrow	A-2-4 Soil
Fine Aggregate	Class II, Type 1 or Class III Select Material
Coarse Aggregate	Class V or VI Select Material

(4) Welded Wire Grid and Metallic Strip Reinforcement

Provide welded wire grid and metallic strip reinforcement supplied by the Wire Wall Vendor or a manufacturer approved or licensed by the vendor. Use welded wire grid reinforcement (“mesh”, “mats” and “ladders”) that meet Article 1070-3 of the *Standard Specifications* and metallic strip reinforcement (“straps”) that meet ASTM A572 or A1011.

Preconstruction Requirements

(A) Concrete Barrier

Define “clear distance” behind concrete barrier as the horizontal distance between the barrier and edge of pavement. The minimum required clear distance for concrete barrier is shown in the plans. At the Contractor’s option or if the minimum required clear distance is not available, set concrete barrier next to and up against traffic side of temporary shoring except for barrier above temporary walls. Concrete barrier with the minimum required clear distance is required above temporary walls.

(B) Temporary Guardrail

Define “clear distance” behind temporary guardrail as the horizontal distance between guardrail posts and temporary shoring. At the Contractor’s option or if clear distance for cantilever, braced and anchored shoring is less than 4 feet, attach guardrail to traffic side of shoring as shown in the plans. Place ABC in clear distance and around guardrail posts instead of pavement. Do not use temporary guardrail above temporary walls.

(C) Temporary Shoring Designs

Before beginning temporary shoring design, survey existing ground elevations in the vicinity of shoring locations to determine actual design heights (H). Submit PDF files of working drawings and design calculations for temporary shoring designs in accordance with Article 105-2 of the *Standard Specifications*. Submit working drawings showing plan views, shoring profiles, typical sections and details of temporary shoring design and construction sequence. Do not begin shoring construction until a design submittal is accepted.

Have cantilever and braced shoring designed, detailed and sealed by an engineer licensed in the state of North Carolina. Use a prequalified Anchored Wall Design Consultant to design anchored shoring. Provide anchored shoring designs sealed by a Design Engineer approved as a Geotechnical Engineer (key person) for an Anchored Wall Design

Consultant. Include details in anchored shoring working drawings of anchor locations and lock-off loads, unit grout/ground bond strengths for ground anchors or minimum installation torque and torsional strength rating for helical anchors and if necessary, obstructions extending through shoring or interfering with anchors. Include details in the anchored shoring construction sequence of pile and anchor installation, excavation and anchor testing.

Provide temporary wall designs sealed by a Design Engineer licensed in the state of North Carolina and employed or contracted by the Temporary Wall Vendor. Include details in temporary wall working drawings of geotextile and reinforcement types, locations and directions and obstructions extending through walls or interfering with reinforcement.

(1) Soil Parameters

Design temporary shoring for the assumed soil parameters and groundwater or flood elevations shown in the plans. Assume the following soil parameters for shoring backfill:

(a) Unit weight (γ) = 120 pcf,

(b)	Friction Angle (ϕ)	Shoring Backfill
	30°	A-2-4 Soil
	34°	Class II, Type 1 or Class III Select Material
	38°	Class V or VI Select Material

(c) Cohesion (c) = 0 psf.

(2) Traffic Surcharge

Design temporary shoring for a traffic surcharge of 250 pounds per square foot if traffic will be above and within H of shoring. This traffic surcharge does not apply to construction traffic. Design temporary shoring for any construction surcharge if construction traffic will be above and within H of shoring. Design temporary shoring for a traffic (live load) surcharge in accordance with Article 11.5.6 of the *AASHTO LRFD Bridge Design Specifications*.

(3) Cantilever, Braced and Anchored Shoring Designs

Use shoring backfill for fill sections and voids between cantilever, braced and anchored shoring and the critical failure surface. Use concrete or Type 1 grout for embedded portions of drilled-in H-piles. Do not use drilled-in sheet piles.

Define “top of shoring” for cantilever, braced and anchored shoring as where the grade intersects the back of sheet piles or H-piles and timber lagging. Design cantilever, braced and anchored shoring for a traffic impact load of 2,000 pounds per foot applied 18 inches above top of shoring if concrete barrier is above and next to shoring or temporary guardrail is above and attached to shoring. Extend

cantilever, braced and anchored shoring at least 32 inches above top of shoring if shoring is designed for traffic impact. Otherwise, extend shoring at least 6 inches above top of shoring.

Design cantilever, braced and anchored shoring for a maximum deflection of 3 inches if the horizontal distance to the closest edge of pavement or structure is less than H. Otherwise, design shoring for a maximum deflection of 6 inches. Design cantilever and braced shoring in accordance with the plans and *AASHTO Guide Design Specifications for Bridge Temporary Works*.

Design anchored shoring in accordance with the plans and Article 11.9 of the *AASHTO LRFD Bridge Design Specifications*. Use a resistance factor of 0.80 for tensile resistance of anchors with bars, strands or shafts. Extend the unbonded length for ground anchors and the shallowest helix for helical anchors at least 5 feet behind the critical failure surface. Do not extend anchors beyond right-of-way or easement limits. If existing or future obstructions such as foundations, guardrail posts, pavements, pipes, inlets or utilities will interfere with anchors, maintain a clearance of at least 6 inches between obstructions and anchors.

(4) Temporary Wall Designs

Use shoring backfill in the reinforced zone of temporary walls. Separation geotextiles are required between shoring backfill and backfill, natural ground or culverts along the sides of the reinforced zone perpendicular to the wall face. For Class V or VI select material in the reinforced zone, separation geotextiles are also required between shoring backfill and backfill or natural ground on top of and at the back of the reinforced zone.

Design temporary walls in accordance with the plans and Article 11.10 of the *AASHTO LRFD Bridge Design Specifications*. Embed temporary walls at least 18 inches except for walls on structures or rock as determined by the Engineer. Use a uniform reinforcement length throughout the wall height of at least 0.7H or 6 feet, whichever is longer. Extend the reinforced zone at least 6 inches beyond end of reinforcement. Do not locate the reinforced zone outside right-of-way or easement limits.

Use the simplified method for determining maximum reinforcement loads in accordance with the AASHTO LRFD specifications. For geotextile reinforcement, use geotextile properties approved by the Department or default values in accordance with the AASHTO LRFD specifications. For geogrid and geostrip reinforcement, use approved geosynthetic reinforcement properties available from the website shown elsewhere in this provision. Use geosynthetic properties for the direction reinforcement will be installed, a 3-year design life and shoring backfill to be used in the reinforced zone.

Do not use more than 4 different reinforcement strengths for each temporary geosynthetic wall. Design temporary geotextile walls for a reinforcement coverage ratio (R_c) of 1.0. For temporary geogrid walls with an R_c of less than

1.0, use a maximum horizontal clearance between geogrids of 3 feet and stagger reinforcement so geogrids are centered over gaps in the reinforcement layer below.

For temporary geosynthetic walls, use “L” shaped welded wire facing with 18 to 24 inch long legs. Locate geosynthetic reinforcement so reinforcement layers are at the same level as the horizontal legs of welded wire facing. Use vertical reinforcement spacing equal to facing height. Wrap geotextile or geogrid reinforcement behind welded wire facing and extend reinforcement at least 3 feet back behind facing into shoring backfill. Attach geostrip reinforcement to welded wire facing with a connection approved by the Department.

For temporary wire walls with separate reinforcement and facing components, attach welded wire grid or metallic strip reinforcement to welded wire facing with a connection approved by the Department. For temporary geogrid, geostrip and wire walls, retain shoring backfill at welded wire facing with retention geotextiles and extend geotextiles at least 3 feet back behind facing into backfill.

(D) Preconstruction Meeting

The Engineer may require a shoring preconstruction meeting to discuss the construction, inspection and testing of the temporary shoring. If required and if this meeting occurs before all shoring submittals have been accepted, additional preconstruction meetings may be required before beginning construction of temporary shoring without accepted submittals. The Resident, District or Bridge Maintenance Engineer, Area Construction Engineer, Geotechnical Operations Engineer, Contractor and Shoring Contractor Superintendent will attend preconstruction meetings.

Construction Methods

Control drainage during construction in the vicinity of shoring. Direct run off away from shoring and shoring backfill. Contain and maintain backfill and protect material from erosion.

Install positive protection in accordance with the contract and accepted submittals. Use PCB in accordance with Section 1170 of the *Standard Specifications* and *Roadway Standard Drawing* No. 1170.01. Use temporary guardrail in accordance with Section 862 of the *Standard Specifications* and *Roadway Standard Drawing* Nos. 862.01, 862.02 and 862.03.

(A) Tolerances

Construct shoring with the following tolerances:

- (1) Horizontal wires of welded wire facing are level in all directions,
- (2) Shoring location is within 6 inches of horizontal and vertical alignment shown in the accepted submittals, and
- (3) Shoring plumbness (batter) is not negative and within 2 degrees of vertical.

(B) Cantilever, Braced and Anchored Shoring Installation

If overexcavation behind cantilever, braced or anchored shoring is shown in the accepted submittals, excavate before installing piles. Otherwise, install piles before excavating for shoring. Install cantilever, braced or anchored shoring in accordance with the construction sequence shown in the accepted submittals. Remove piles and if applicable, timber lagging when shoring is no longer needed.

(1) Pile Installation

Install piles with the minimum required embedment and extension in accordance with Subarticles 450-3(D) and 450-3(E) of the *Standard Specifications* except that a pile driving equipment data form is not required. Piles may be installed with a vibratory hammer as approved by the Engineer.

Do not splice sheet piles. Use pile excavation to install drilled-in H-piles. After filling holes with concrete or Type 1 grout to the elevations shown in the accepted submittals, remove any fluids and fill remaining portions of holes with flowable fill. Cure concrete or grout at least 7 days before excavating.

Notify the Engineer if refusal is reached before pile excavation or driven piles attain the minimum required embedment. When this occurs, a revised design submittal may be required.

(2) Excavation

Excavate in front of piles from the top down in accordance with the accepted submittals. For H-piles with timber lagging and braced and anchored shoring, excavate in staged horizontal lifts with a maximum height of 5 feet. Remove flowable fill and material in between H-piles as needed to install timber lagging. Position lagging with at least 3 inches of contact in the horizontal direction between the lagging and pile flanges. Do not excavate the next lift until timber lagging for the current lift is installed and if applicable, bracing and anchors for the current lift are accepted. Backfill behind cantilever, braced or anchored shoring with shoring backfill.

(3) Anchor Installation

If applicable, install foundations located behind anchored shoring before installing anchors. Fabricate and install ground anchors in accordance with the accepted submittals, Articles 6.4 and 6.5 of the *AASHTO LRFD Bridge Construction Specifications* and the following unless otherwise approved:

- (a) Materials in accordance with this provision are required instead of materials conforming to Articles 6.4 and 6.5.3 of the *AASHTO LRFD Specifications*,

- (b) Encapsulation-protected ground anchors in accordance with Article 6.4.1.2 of the AASHTO LRFD specifications are not required, and
- (c) Corrosion protection for unbonded lengths of ground anchors and anchorage covers are not required.
- (d) Mix and place neat cement grout in accordance with Subarticles 1003-5, 1003-6 and 1003-7 of the *Standard Specifications*. Measure grout temperature, density and flow during grouting with at least the same frequency grout cubes are made for compressive strength. Perform density and flow field tests in the presence of the Engineer in accordance with American National Standards Institute/American Petroleum Institute Recommended Practice 13B-1 (Section 4, Mud Balance) and ASTM C939 (Flow Cone), respectively.

Install helical anchors in accordance with the accepted submittals and Anchor Manufacturer's instructions. Measure torque during installation and do not exceed the torsional strength rating of the helical anchor. Attain the minimum required installation torque and penetration before terminating anchor installation. When replacing a helical anchor, embed last helix of the replacement anchor at least 3 helix plate diameters past the location of the first helix of the previous anchor.

(4) Anchor Testing

Proof test and lock-off anchors in accordance with the accepted submittals and Article 6.5.5 of the *AASHTO LRFD Bridge Construction Specifications* except for the acceptance criteria in Article 6.5.5.5. For the AASHTO LRFD specifications, "ground anchor" refers to a ground or helical anchor and "tendon" refers to a bar, strand or shaft.

(a) Anchor Acceptance

Anchor acceptance is based in part on the following criteria.

- (i) For ground and helical anchors, total movement is less than 0.04 inches between the 1 and 10 minute readings or less than 0.08 inches between the 6 and 60 minute readings.
- (ii) For ground anchors, total movement at maximum test load exceeds 80% of the theoretical elastic elongation of the unbonded length.

(b) Anchor Test Results

Submit PDF files of anchor test records including movement versus load plots for each load increment within 24 hours of completing each row of anchors. The Engineer will review the test records to determine if the anchors are acceptable.

If the Engineer determines an anchor is unacceptable, revise the anchor design or installation methods. Submit a revised anchored shoring design for acceptance and provide an acceptable anchor with the revised design or installation methods. If required, replace the anchor or provide additional anchors with the revised design or installation methods.

(C) Temporary Wall Installation

Excavate as necessary for temporary walls in accordance with the plans and accepted submittals. If applicable, install foundations located in the reinforced zone before placing shoring backfill or reinforcement unless otherwise approved. Notify the Engineer when foundation excavation is complete. Do not place shoring backfill or reinforcement until excavation dimensions and foundation material are approved.

Erect welded wire facing so the wall position is as shown in the plans and accepted submittals. Set welded wire facing adjacent to each other in the horizontal and vertical direction to completely cover the wall face with facing. Stagger welded wire facing to create a running bond by centering facing over joints in the row below.

Attach geostrip reinforcement to welded wire facing and wrap geotextile reinforcement and retention geotextiles behind welded wire facing as shown in the plans and accepted submittals. Cover geotextiles with at least 3" of shoring backfill. Overlap adjacent geotextile reinforcement and retention and separation geotextiles at least 18 inches with seams oriented perpendicular to the wall face. Hold geotextiles in place with wire staples or anchor pins as needed.

Place reinforcement within 3 inches of locations shown in the plans and accepted submittals. Before placing shoring backfill, pull geosynthetic reinforcement taut so it is in tension and free of kinks, folds, wrinkles or creases. Install reinforcement with the direction shown in the plans and accepted submittals. For temporary wire walls with separate reinforcement and facing components, attach welded wire grid or metallic strip reinforcement to welded wire facing as shown in the accepted submittals. Do not splice or overlap reinforcement so seams are parallel to the wall face. Contact the Engineer when unanticipated existing or future obstructions such as foundations, pavements, pipes, inlets or utilities will interfere with reinforcement.

Place shoring backfill in the reinforced zone in 8 to 10 inch thick lifts. Compact A-2-4 soil and Class II, Type 1 and Class III select material in accordance with Subarticle 235-3(C) of the *Standard Specifications*. Use only hand operated compaction equipment to compact backfill within 3 feet of welded wire facing. At a distance greater than 3 feet, compact shoring backfill with at least 4 passes of an 8 to 10 ton vibratory roller in a direction parallel to the wall face. Smooth wheeled or rubber tired rollers are also acceptable for compacting backfill. Do not use sheepsfoot, grid rollers or other types of compaction equipment with feet. Do not displace or damage reinforcement when placing and compacting shoring backfill. End dumping directly on geosynthetics is not permitted. Do not operate heavy equipment on reinforcement until it is covered with at least 8 inches of shoring backfill. Replace any damaged reinforcement to the satisfaction of the Engineer.

Backfill for temporary walls outside the reinforced zone in accordance with Article 410-8 of the *Standard Specifications*. Bench temporary walls into the sides of excavations where applicable. For temporary geosynthetic walls with top of wall within 5 feet of finished grade, remove top facing and incorporate top reinforcement layer into fill when placing fill in front of wall. Temporary walls remain in place permanently unless otherwise required.

Measurement and Payment

Temporary Shoring will be measured and paid in square feet. Temporary walls will be measured as the square feet of exposed wall face area. Cantilever, braced or anchored shoring will be measured as the square feet of exposed shoring face area with the shoring height equal to the difference between the top and bottom of shoring elevations. Define “top of shoring” as where the grade intersects the back of sheet piles or H-piles and timber lagging. Define “bottom of shoring” as where the grade intersects front of sheet piles or H-piles and timber lagging. No measurement will be made for any embedment, shoring extension above top of shoring or pavement thickness above temporary walls.

The contract unit price for *Temporary Shoring* will be full compensation for providing shoring designs, submittals and materials, excavating, backfilling, hauling and removing excavated materials and supplying all labor, tools, equipment and incidentals necessary to construct temporary shoring.

No payment will be made for temporary shoring not shown in the plans or required by the Engineer including shoring for OSHA reasons or the Contractor’s convenience. No value engineering proposals will be accepted based solely on revising or eliminating shoring locations shown in the plans or estimated quantities shown in the bid item sheets as a result of actual field measurements or site conditions.

PCB will be measured and paid in accordance with Article 1170-4 of the *Standard Specifications*. No additional payment will be made for anchoring PCB for temporary shoring. Costs for anchoring PCB will be incidental to temporary shoring.

Temporary guardrail will be measured and paid for in accordance with Article 862-6 of the *Standard Specifications*.

Payment will be made under:

Pay Item

Temporary Shoring

Pay Unit

Square Foot

CONES:

(3-19-24)

1135

SP11 R35

Revise the *Standard Specifications* as follows:

Page 11-11, Article 1135-3 CONSTRUCTION METHODS, lines 19-20, delete the third sentence of the first paragraph, "Do not use cones in the upstream taper of lane or shoulder closures for multi-lane roadways."

FLAGGERS:

(12-17-24)(Rev. 12-23-25)

1150

SP11 R50

Revise Section 1150 of the *Standard Specification* as follows:

Page 11-13, Article 1150-1, DESCRIPTION, add the following after line 31:

Alternatively, at the discretion of the Contractor, the Contractor may furnish, install, place in operation, repair, maintain, relocate, and remove remotely controlled Automated Flagging Assistance Devices (AFAD) or Temporary Portable Traffic Signal units (PTS units) to assist, supplement, or replace human flaggers for one-lane, two-way traffic maintenance during construction in accordance with this provision and the *Standard Specifications*.

For the purpose of this provision, an "approach" refers to a single lane of traffic moving in one direction toward a point of control or work zone. Flaggers, AFAD and PTS units are only used to control one lane of approaching traffic in a specific direction.

Page 11-13, Article 1150-2, MATERIALS, add the following after line 34:

Provide documentation to the Engineer that the AFAD or PTS units meets or exceeds the requirements of this special provision and is on the NCDOT APL or ITS and Signals QPL.

(A) Automated Flagging Assistance Devices (AFAD)**(1) AFAD General**

Cover the automated gate arm with Department approved Type VII, VIII or IX retroreflective sheeting of vertical alternating red and white stripes at 16 inch intervals measured horizontally. When the gate arm is in the down position the minimum vertical aspect of the arm and sheeting shall be 4 inches. The retroreflectorized sheeting shall be on both sides of the gate arm. With the AFAD parked or positioned 2 feet outside or in a location deemed acceptable for the lane being controlled, the gate arm shall reach at least to the center of the lane but shall not exceed the width of the lane being controlled.

Design the system to be fail-safe. Provide a conflict monitor, malfunction monitoring unit, or similar device that monitors for malfunctions and prevents the display of conflicting indications. This system shall be electronic and operated by remote control.

(2) AFAD Type I System: RED/YELLOW

Provide a Red/Yellow AFAD with at least one set of CIRCULAR RED and CIRCULAR YELLOW lenses in a vertical configuration that are 12 inches in diameter. The bottom of the housing (including brackets) shall be at least 7 feet (2.1 meters) above the pavement.

This system is required to have yellow 12 inch aluminum or polycarbonate vehicle signal heads with 10 inch tunnel visors, backplates, and Light Emitting Diode (LED) modules. Provide signal heads, backplates, and LED modules listed on the ITS and Signals QPL available on the Department's website.

Provide an automated gate arm on the AFAD that descends to a down position across the approaching lane of traffic when the steady CIRCULAR RED lens is illuminated and then ascends to an upright position when the flashing CIRCULAR YELLOW lens is illuminated. The automated gate arm is to be designed such that if a motorist pulls underneath the gate arm while lowering, no damage to the vehicle occurs.

A STOP HERE ON RED (R10-6 or R10-6a) sign shall be installed on the right-hand side of the approach at the point at which drivers are expected to stop when the steady CIRCULAR RED lens is illuminated.

To stop traffic, the AFAD shall transition from the flashing CIRCULAR YELLOW lens by initiating a minimum 5 second steadily illuminated CIRCULAR YELLOW lens followed by the CIRCULAR RED lens.

Once the CIRCULAR RED lens is displayed, the system is to have a minimum 2 second delay between the time the steady CIRCULAR RED is displayed and the time the gate arm begins to lower. The maximum delay between CIRCULAR RED and the time the gate arm lowers is 4 seconds. To permit stopped road users to proceed, the AFAD shall display the flashing CIRCULAR YELLOW lens and the gate arm shall be placed in the upright position.

Ensure the system monitors for a lack of yellow or red signal voltage, total loss of indication in any direction, presence of multiple indications on any approach and low power conditions.

Additional sets of CIRCULAR RED and CIRCULAR YELLOW lenses located over the roadway or on the left side of the approach and operated in unison with the primary set, may be used to improve visibility of the AFAD. If the set of lenses is located over any portion of the roadway that can be used by motor vehicles, the bottom of the housing (including brackets) shall be at least 15 feet (4.6 meters) above the pavement.

(3) AFAD Type II System: STOP/SLOW

Provide STOP/SLOW signs that are octagonal in shape, made of rigid material, and at least 36 inch x 36 inch in size. Letters shall be a minimum of 8 inches high. The STOP face shall have a red background with white letters and border.

The SLOW face shall be diamond shaped, orange, or yellow background with black letters and border. Cover both faces in a Department approved Type VII, VIII or IX

retroreflective sheeting. The minimum mounting height for the sign faces shall be 7 feet above the pavement to the bottom of the sign.

The AFAD's STOP/SLOW signs shall be supplemented with active conspicuity devices by incorporating a stop beacon (red lens) and a warning beacon (yellow lens). The stop beacon shall be no more than 24 inches above the STOP face. Mount the warning beacon no more than 24 inches above or beside of the SLOW face. Except for the mounting locations, the beacons shall conform to the provisions of Chapter 4L of the MUTCD and have 12 inch signal lenses.

Strobe/flashing lights are an acceptable alternative to flashing beacons. If utilized, they shall be either white or red flashing lights located within the STOP face and white or yellow flashing lights within the SLOW face and conform to the provisions of Chapter 6D of the MUTCD. If used, the lens diameter shall be a minimum of 5 inches with a minimum height of 6 inches. Equip strobes/flashing lights for both dual and quad flash patterns.

Type B warning lights shall not be used in lieu of the beacons or the strobe lights.

The faces of the AFADs STOP/SLOW sign may include louvers. If louvers are used, design the louvers such that the aspect of the sign face to approaching traffic is a full sign face at a distance of 50 feet or greater.

A WAIT ON STOP (R1-7) sign and a GO ON SLOW (R1-8) sign shall be displayed to traffic approaching the AFAD. Position signs on the same support structure as the AFAD. Both signs shall have black legends and borders on white Type III sheeting backgrounds. Each of these signs shall be rectangular in shape and be at least 24 inch x 30 inch size with letters at least 6 inches high.

Provide an automated gate arm on the AFAD that descends to a down position across the approaching lane of traffic when the STOP face is displayed and then ascends to an upright position when the SLOW face is displayed.

The automated gate arm is to be designed such that if a motorist pulls underneath the gate arm while lowering, no damage to the vehicle occurs.

A STOP HERE ON RED (R10-6 or R10-6a) sign shall be installed on the right-hand side of the approach at the point at which drivers are expected to stop when the STOP face is displayed.

When approaching motorists are to proceed, display the SLOW face and the warning beacon or strobes are to flash on the AFAD. When approaching motorists are will be stopped, display the STOP face and the stop beacon or strobes are to flash on the AFAD.

To stop traffic, the AFAD will transition from the SLOW face to the STOP face by initiating a minimum 5 second change cycle. First, the warning beacon is to steadily illuminated for the change cycle. If strobes are used in lieu of a warning beacon, they are to be placed in the quad flash pattern. At the end of the change

cycle, the STOP face is to be displayed with the stop beacon flashing and the warning beacon or strobes are to stop flashing. Once the STOP face is displayed, the system is to have a minimum 2 second delay between the time the STOP face is displayed and the time the gate arm begins to lower. The maximum delay between the time the STOP face is displayed and the time the gate arm lowers is 4 seconds.

To permit stopped road users to proceed, the gate arm shall be placed in the upright position and the AFAD shall display the SLOW face and the warning beacon or strobes are to flash in the dual flash pattern.

Do not flash the stop beacon when the SLOW face is displayed, and do not flash the warning beacon when the STOP face is displayed.

(B) Portable Traffic Signals (PTS) Units

Provide PTS units with at least one set of CIRCULAR RED, CIRCULAR YELLOW, and CIRCULAR GREEN lenses in a vertical configuration that are 12 inch diameter aluminum or polycarbonate vehicle signal heads with 10 inch tunnel visors, backplates, and Light Emitting Diode (LED) modules. All signal heads, tunnel visors, and backplates shall be yellow in color.

The bottom of the housing (including brackets) shall be at least 7 feet above the pavement for single set units. Additional signal heads on units with more than one signal head shall be capable of extending over the travel lane.

Communication Requirements

All PTS units within the signal set up systems shall maintain communication at all times by either hardwire cable or wireless radio link communication. If the hardwire cable communication is utilized the communication cable shall be deployed in a manner that will not intrude in the direct work area of the project or obstruct vehicular and pedestrian traffic. Utilize radio communication with 900MHz frequency band and frequency hopping capability. The radio link communication system shall have a minimum range of 1 mile.

Fault Mode Requirements

Revert PTS units to a flashing red mode upon system default unless otherwise specified by the Engineer. Equip the PTS units with a remote monitoring system. Where cell communication availability exists, the remote monitoring system shall adhere to the remote monitoring system section of this provision.

Remote Monitoring System

The remote monitoring system (RMS) shall be capable of reporting signal location, battery voltage / battery history and system default. Provide a password protected website viewable from any computer with internet capability for the RMS. In the event

of a system default, the RMS shall provide specific information concerning the cause of the system default (i.e. red lamp on signal number 1). Equip the RMS with a mechanism capable of immediately contacting a minimum of three previously designated individuals via text messaging and/or email upon a default.

The running program operating the PTS units shall be always available and viewable through the RMS website. Maintain a history of the RMS operating system in each signal including operating hours and events and the location of the PTS units.

Trailer / Cart

The AFAD and PTS units may be mounted on either a trailer or a moveable cart system.

Finish all exterior metal surfaces with Federal orange enamel per AMS-STD-595, color chip ID# 13538 or 12473 respectively with a minimum paint thickness of 2.5 mils (64 microns).

Design and test the AFAD or PTS units trailer / cart to withstand an 80 MPH wind load while in the operational position. Provide independent certification that the assembly meets the design wind load.

Equip the AFAD or PTS units with leveling jacks capable of stabilizing the unit in a horizontal position when located on slopes 6:1 or flatter.

Equip trailers in compliance with North Carolina Law governing motor vehicles and include a 12-volt trailer lighting system complying with *Federal Motor Carrier Safety Regulations 393*, safety chains and a minimum 2 inch ball hitch.

Provide a minimum 4 inch wide strip of fluorescent conspicuity sheeting retroreflective sheeting to the frame of the trailer. Apply the sheeting to all sides of the trailer. The sheeting shall meet the ASTM requirements of Type VII, VIII or IX.

Power System

Design the systems to operate both with and without an external power source. Furnish transmitters, generators, batteries, controls and all other components necessary to operate the device.

Provide equipment that is solar powered and supplemented with a battery backup system that includes a minimum 110/120 VAC powered on-board charging system capable of powering the unit for 7 continuous days with no solar power. Each unit shall also be capable of being powered by standard 110/120 VAC power sources, if applicable.

Locate batteries and electronic controls in a locked, weather and vandal resistant housings.

Page 11-14, Article 1150-3, CONSTRUCTION METHODS, add the following after line 11:

Flaggers shall have a path to escape an errant approaching vehicle at all times, unimpeded by barrier, guardrail, guiderail, parked vehicles, construction materials, slopes steeper than 2:1, or

any other obstruction at all times. If an unimpeded path cannot be maintained, the Contractor shall use AFAD or PTS units in lieu of a flagger.

Provide documentation to the Engineer prior to deploying the device that the AFAD or PTS units operator(s) are qualified flagger(s) that have been properly trained through an NCDOT approved training agency or other NCDOT approved training provider and that the qualified flagger(s) have received manufacturer training to operate that specific device. This training shall include proper installation, remote control operation, central control systems and maintenance of the AFAD or PTS units. The training shall take place off the project site where training conditions are removed from live traffic. The documentation shall include the names of the authorized trainer, the trainees, the device on which they have been trained and the date of the training. Provide updated documentation to the Engineer prior to deploying any additional operators.

Install advance warning signs and operate AFADs in accordance with the attached detail drawings in this provision.

Install advance warning signs and operate PTS units in accordance with *NCDOT Roadway Standard Drawings* No. 1101.02, Sheet 17.

AFAD and PTS units shall only be used in situations where there is only one lane of approaching traffic in the direction to be controlled. **At no time shall an AFAD unit controlling traffic through the work area be placed in an autonomous mode and/or left unattended.**

Signal timing and operation of PTS units shall be field verified and accepted by the Engineer before use.

Do not use AFAD or PTS units in locations where queueing from the AFAD or PTS units will extend to within 150 feet of a signalized intersection or railroad crossing. Do not use AFAD and PTS units as a substitute for or a replacement for a continuously operating temporary traffic control signal as described in Section 6F.84 of the MUTCD.

If used at night, illuminate each AFAD or PTS units as described in Section 6D of the MUTCD.

Provide a complete AFAD or PTS units that is capable of being relocated as traffic conditions demand.

If AFADs or PTS units become inoperative, be prepared at all times to replace the unit with the same type and model of AFAD or PTS units, revert to human flagging operations or terminate all construction activities requiring the use of the AFAD or PTS units until the AFAD or PTS units become operative or qualified human flaggers are available.

When the work requiring the AFAD or PTS units is not pursued for 30 minutes or longer, power off each AFAD or PTS units. Remove the AFAD or PTS units from the travel lane and relocated to a minimum of 5 feet from the edge line. AFAD gate arms shall be in the upright position. Remove all traffic control devices from the road, place two cones by each AFAD or PTS units and all signs associated with the lane closure operation shall be removed or laid down. At the end of each workday, remove all AFADs or PTS units from the roadway and shoulder areas.

Ensure the system's wireless communication links continuously monitor and verify proper transmission and reception of data used to monitor and control each AFAD or PTS units. Ensure ambient mobile or other radio transmissions or adverse weather conditions do not affect the system.

In the event of a loss of communications, immediately display the flashing RED or STOP indication on all AFAD or PTS units.

AFAD Specific Construction Methods

The flagger/operator controlling the AFAD units shall be on the project site at all times. If multiple AFAD units are used, one AFAD unit shall be the Main AFAD unit and all other units shall be remote AFAD units. Ensure that each device meets the physical display and operational characteristics as specified in the MUTCD.

Multiple AFAD units may be controlled with **one** flagger/operator when the AFAD units meet each of the following requirements:

- (1) AFAD units are spaced no greater than the manufacturer's recommendations.
- (2) Both AFAD units can be seen at the same time from the flagger/operator's position, or the AFAD is operating on its own secure network with malfunction detection and notification to the flagger/operator.
- (3) The flagger/operator has an unobstructed view of approaching traffic in both directions from the flagger/operator position or the AFAD is operating on its own secure network, with cameras that provide the flagger/operator an unobstructed view of approaching traffic from both directions. The flagger/operator may control the AFAD units from a pilot vehicle.

If any of the above requirements are not met, flagger/operator control each AFAD unit.

AFAD operators may either control traffic at side streets or driveways between the AFAD units or operate the pilot car while operating the AFAD system if approved by the Engineer. AFAD units must continue to be within clear sight of the operator during these work activities.

Page 11-14, Article 1150-4, MEASUREMENT AND PAYMENT, add the following after line 24:

Each AFAD or PTS unit will be measured and paid for as *Flaggers* paid by day in accordance with Article 1150-4 of the *Standard Specifications*. Where the pay item for *Flaggers* is not included in the original contract then no separate payment will be made for this item and payment will be included in the lump sum price bid for *Temporary Traffic Control* found elsewhere in this contract. Each approach controlled by AFAD or PTS units will be measured and paid as one flagger, irrespective of the number of devices used. If multiple PTS units are required to control a single approach, these units will collectively be considered as replacing one flagger.

No separate measurement or payment will be made for AFAD or PTS unit operators, as the cost of such including their training and operational costs shall be included in the unit or lump sum price for *Flaggers* or *Temporary Traffic Control*. Such price and payment also includes the relocation, maintenance, and removal during repair periods of AFAD or PTS units as well as the signal controller, communication, vehicle detection system, traffic signal software of PTS units and any other incidentals necessary to complete the work.

Red/Yellow Lens AFAD (TYPE I)

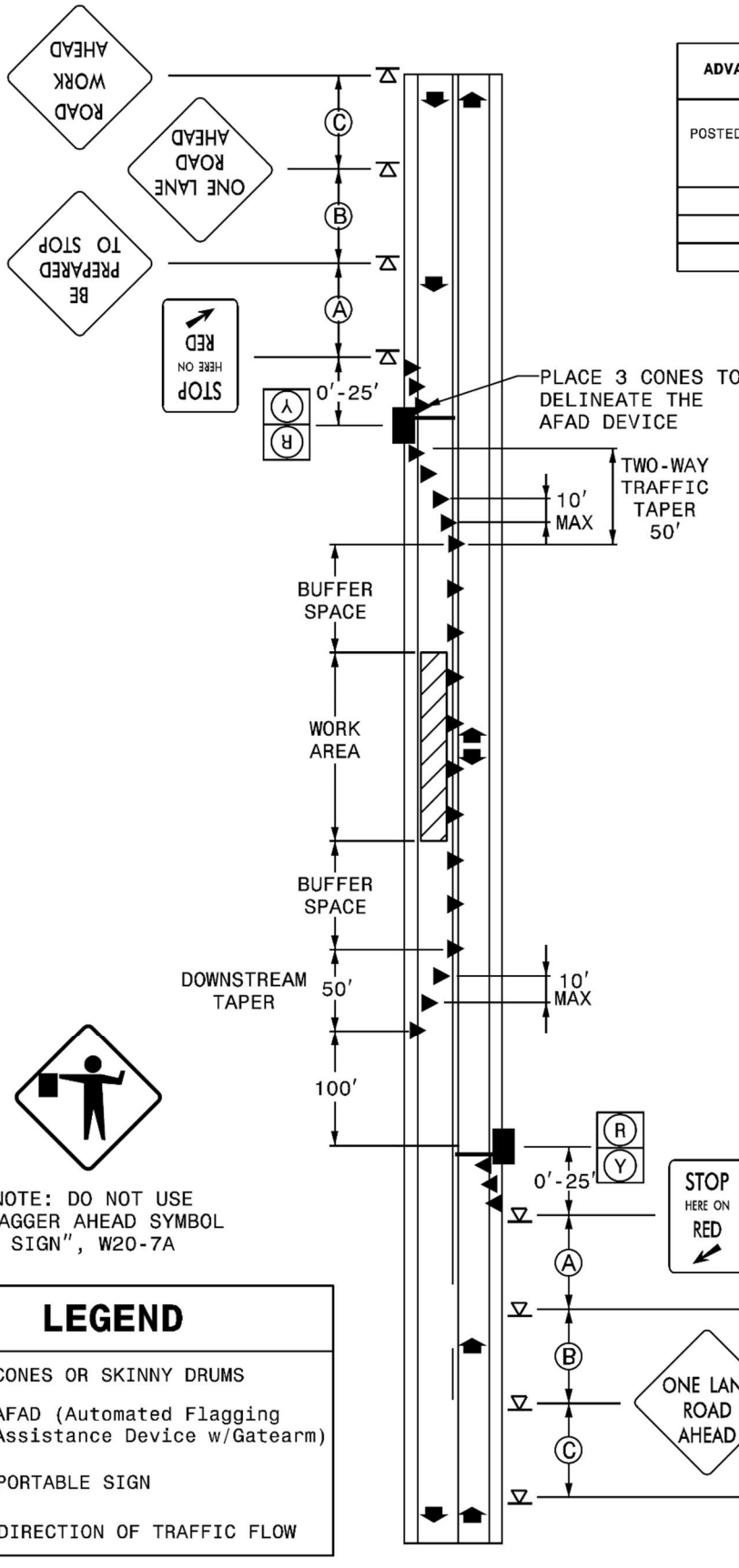





ADVANCE WARNING SIGN SPACING CHART			
POSTED SPEED LIMIT (MPH)	RECOMMENDED DISTANCE BETWEEN SIGNS FEET (+/-) SEE NOTE #1		
	(A)	(B)	(C)
≤ 35	200	200	200
40-50	350	350	350
55	500	500	500

DESIGN SPEED (MPH)	BUFFER SPACE (FEET)
30	85
35	120
40	155
45	195
50	240
55	290
60	345
65	405
70	470
75	540
80	615

NOTE: DO NOT USE "FLAGGER AHEAD SYMBOL SIGN", W20-7A

LEGEND

-  CONES OR SKINNY DRUMS
-  AFAD (Automated Flagging Assistance Device w/Gatearm)
-  PORTABLE SIGN
-  DIRECTION OF TRAFFIC FLOW

PORTABLE CONCRETE BARRIER:

(12-17-24)

1170

SP11 R70

Revise the *Standard Specifications* as follows:

Page 11-17, Subarticle 1170-3(A)(1) Portable Concrete Barrier, after line 25, add the following:

For MASH approved F-Shape K-Wall, install anchorage transitions between unanchored portable concrete barrier and temporary crash cushions, and between unanchored portable concrete barrier and portable concrete barrier (anchored) as shown in the *Roadway Standard Drawings*, No. 1170.01.

Page 11-19, Article 1170-4 MEASUREMENT AND PAYMENT, line 16, after the second sentence of the first paragraph add the following:

Crash cushion to unanchored concrete requires a transition

Page 11-19, Article 1170-4 MEASUREMENT AND PAYMENT, line 13, delete and replace “*Portable Concrete Barrier (____)*” with “*Portable Concrete Barrier*”.

Page 11-19, Article 1170-4 MEASUREMENT AND PAYMENT, line 16, after the second sentence of the first paragraph add the following:

As shown in the *Roadway Standard Drawings*, No. 1170.01, anchorage transition sections between *Portable Concrete Barrier* and *Temporary Crash Cushions* as found in Section 1160 will be measured and paid as *Portable Concrete Barrier*. No additional payment will be made for equipment, materials or labor to meet the anchorage transition requirements.

Page 11-19, Article 1170-4 MEASUREMENT AND PAYMENT, line 16, after the first paragraph add the following:

Portable Concrete Barrier (Anchored) will be measured and paid as the maximum number of linear feet furnished, satisfactorily installed, accepted by the Engineer, maintained and removed, at any one time during the life of the project, including anchorage transition sections between portable concrete barrier and portable concrete barrier (anchored) as shown in the *Roadway Standard Drawings*, No. 1170.01. Measurement will be made by counting the number of barrier units used and multiplying by the length of a unit.

Page 11-19, Article 1170-4 MEASUREMENT AND PAYMENT, line 21, delete and replace “*Remove and Reset Portable Concrete Barrier (____)*” with “*Remove and Reset Portable Concrete Barrier*”.

Page 11-19, Article 1170-4 MEASUREMENT AND PAYMENT, line 24, after the second sentence of the third paragraph add the following:

As shown in the *Roadway Standard Drawings*, No. 1170.01, anchorage transition sections between *Portable Concrete Barrier* and *Temporary Crash Cushions* as found in Section 1160 will be measured and paid as *Remove and Reset Portable Concrete Barrier*. No additional

payment will be made for equipment, materials or labor to meet the anchorage transition requirements.

Page 11-19, Article 1170-4 MEASUREMENT AND PAYMENT, line 28, after the third paragraph add the following:

Remove and Reset Portable Concrete Barrier (Anchored) will be measured and paid as the number of linear feet of barrier moved from one location on the project to another location on the project, including anchorage transition sections between portable concrete barrier and portable concrete barrier (anchored) as shown in the Roadway Standard Drawings, No. 1170.01. Measurement will be made by counting the number of barrier units moved during any one move and multiplying by the length of a unit. Where barrier units are moved more than once, each move will be measured separately. Whenever the Engineer directs the Contractor to move barrier units from an installed location to a stockpile either on or off the project and then back to another installed location, the complete move from the first installed location to the next installed location will be measured as 2 moves.

SNOWPLOWABLE DELINEATION:

(10-15-24)

1253

SP12 R53

Description

Furnish, install and maintain snowplowable delineation.

There are five snowplowable delineation alternate options approved for use in North Carolina. They include the following markers and markings options:

- (1) Polycarbonate H-shaped Markers
- (2) Inlaid Raised Pavement Markers
- (3) 10' Rumble Skips
- (4) Inlaid Cradle Markers
- (5) 10' Inlaid Pavement Markings

Only one type of snowplowable delineation will be allowed on a single project.

Materials

Refer to Division 10 of the *Standard Specifications*.

Item	Section
Epoxy	1081
Pavement Markings	1087
Snowplowable Pavement Markers	1086-3

Any snowplowable pavement delineation shall conform to the applicable requirements of Sections 1086, 1087, and 1081 of the *Standards and Specifications*. Use snowplowable delineation markers and markings listed on the NCDOT APL. Any treatment that requires pavement cutting or milling shall be installed within 7 calendar days of the pavement cutting or milling operation.

Construction Methods**(A) General**

For any snowplowable delineation, prior to installation, by brushing, blow cleaning, vacuuming or other suitable means, ensure that all materials and the pavement surface are free of dirt, grease, dust, oil, moisture, mud, grass, or any other material that would prevent adhesion to the pavement by brushing blow cleaning, or vacuuming. If required, apply a primer per manufactures recommendations to pavement surfaces before applying pavement marking material.

Install snowplowable delineation per manufacturers specifications every 80 feet. Make sure pavement markers are oriented to traffic correctly and pavement markings are applied in a uniform thickness. Do not apply markings over longitudinal joints. Protect the pavement markings until they are tack free. Apply applicable Sections 1205 and 1250 of the *Standards Specifications*.

If damage occurs during installation the effected treatments shall be corrected or replaced. This work shall be considered incidental to the installation of the marking or marker.

(B) Polycarbonate H-shaped Markers and Inlaid Cradle Markers

Bond marker housings to the pavement with epoxy adhesive. Mechanically mix and dispense epoxy adhesives as required by the manufacturer's specifications. Place the markers immediately after the adhesive has been mixed and dispensed.

Install polycarbonate H-shaped markers and inlaid cradle markers castings into slots sawcut into the pavement. Make slots in the pavement to exactly duplicate the shape of the casting of the polycarbonate H-shaped markers and inlaid cradle markers.

If saw cutting, milling, or grooving operations are used, promptly remove all resulting debris from the pavement surface. Install the marker housings within 7 calendar days after saw cutting , milling, or grooving the pavement. Remove and dispose of loose material from the slots by brushing, blow cleaning or vacuuming. Dry the slots before applying the epoxy adhesive. Install polycarbonate H-shaped markers and inlaid cradle markers according to the manufacturer's recommendations.

Protect the polycarbonate H-shaped markers or inlaid cradle markers until the epoxy has initially cured and is track free.

Construct inlaid cradle markers in accordance with the details in the plans and as directed by the Engineer.

(C) Reflector Replacement

The following requirements only apply to polycarbonate H-shaped markers and inlaid cradle markers.

In the event that a reflector is damaged, replace the damaged reflector by using adhesives and methods recommended by the manufacturer of the markers and approved by the Engineer. This work is considered incidental if damage occurs during the initial installation of the marker housings and maintenance of initial polycarbonate H-shaped markers or inlaid cradle markers specified in this section.

If during reflector replacement it is discovered that the housing is missing or broken this will be paid as *Polycarbonate H-shaped Markers* or *Inlaid Cradle Markers*. Missing housings shall be replaced. Broken housings shall be removed and replaced. In both cases the slot for the housings shall be properly prepared prior to installing the new housing; patch the existing marker slots as directed by the Engineer and install the new marker approximately one foot before or after the patch. Removal of broken housings and preparation of slots will be considered incidental to the work of replacing housings.

(D) Inlaid Raised Pavement Markers

Cut groove in accordance with the details in the plans and as directed by the Engineer.

Use adhesive recommended by the manufacturer to install markers into the groove in accordance with Section 1251. The raised pavement markers are incidental to inlaid raised pavement markers.

(E) 10' Rumble Skips

Construct 10' rumble skips on asphalt concrete in accordance with Section 665 for all centerline and shoulder rumble skips, details in the plans and as directed by the Engineer. Construct 10' rumble skips on Portland cement concrete in accordance with Section 730 for all centerline and shoulder rumble skips, details in the plans and as directed by the Engineer. The milled rumble strips are incidental to the rumble skips. Using polyurea or extruded 90 mil thermoplastic construct pavement markings in accordance with Section 1205.

(F) 10' Inlaid Pavement Markings

The groove in which the marking is to be placed shall be one inch wider than the marking to be placed and 10 mils deeper than the thickness of the marking.

When using this method, use enhanced reflective media. The following retroreflectivity values shall be met.

MINIMUM INITIAL REFLECTOMETER READINGS		
Item	Color	Reflectivity
Enhanced Reflectivity Media	White	450 mcd/lux/m ²
	Yellow	350 mcd/lux/m ²

Using polyurea, extruded 90 mil thermoplastic or cold applied plastic construct pavement markings in accordance with Section 1205.

Maintenance

Maintain all installed snowplowable delineation before acceptance by the Engineer.

Measurement and Payment

Polycarbonate H-shaped Markers will be measured and paid as the actual number of polycarbonate H-shaped markers satisfactorily placed and accepted by the Engineer.

Inlaid Raised Pavement Markers will be measured and paid as the actual number of inlaid raised pavement markers satisfactorily placed and accepted by the Engineer.

10' Rumble Skips will be measured and paid as the actual number of rumble skips satisfactorily placed and accepted by the Engineer.

Inlaid Cradle Markers will be measured and paid as the actual number of pavement markers satisfactorily placed and accepted by the Engineer.

10' Inlaid Pavement Markings will be measured and paid as the actual number of 10' inlaid pavement markings satisfactorily placed and accepted by the Engineer.

Replace Snowplowable Pavement Marker Reflector will be measured and paid in accordance with Article 1253-5.

Payment will be made under:

Pay Item	Pay Unit
Polycarbonate H-shaped Markers	Each
Inlaid Raised Pavement Markers	Each
10' Rumble Skips	Each
Inlaid Cradle Markers	Each
10' Inlaid Pavement Markings	Each

PERMANENT SEEDING AND MULCHING:

(7-1-95)(Rev. 1-16-24)

1660

SP16 R02

The Department desires that permanent seeding and mulching be established on this project as soon as practical after slopes or portions of slopes have been graded. As an incentive to obtain an early stand of vegetation on this project, the Contractor's attention is called to the following:

For all permanent seeding and mulching that is satisfactorily completed in accordance with the requirements of Section 1660 in the *Standard Specifications* and within the following percentages of elapsed contract times, an additional payment will be made to the Contractor as an incentive additive. The incentive additive will be determined by multiplying the number of acres of seeding and mulching satisfactorily completed times the contract unit bid price per acre for Seeding and Mulching times the appropriate percentage additive.

Percentage of Elapsed Contract Time	Percentage Additive
0% - 30%	30%
30.01% - 50%	15%

Percentage of elapsed contract time is defined as the number of calendar days from the date of availability of the contract to the date the permanent seeding and mulching is acceptably completed divided by the total original contract time.

COIR FIBER MAT:

(9-16-25)

1629

SP16 R05

Page 16-9, Article 1629-2 MATERIALS, lines 22-24, delete and replace the last paragraph with the following:

Provide #3 or #4 uncoated reinforcing steel anchors, 24 inches in length, bent into a U-shape with a 4-inch diameter bend and a 4-inch straight leg extending from the bend to catch and secure the coir fiber mat.

WATTLE DEVICES:

(1-1-24)(Rev. 9-16-25)

1642

SP16 R10

Page 16-23, Subarticle 1642-2(B) Wattle, lines 10-12, delete and replace with the following:

(B) Wattle and Wattle Barrier

Wattles shall meet Table 1642-1.

TABLE 1642-1	
100% CURLED WOOD (EXCELSIOR) FIBERS - WATTLE	
Property	Property Value
Minimum Diameter	12 inches
Minimum Density	2.5 pcf +/- 10%
Net Material	Synthetic
Net Openings	1 inch x 1 inch
Net Configuration	Totally Encased
Minimum Weight	20 lb +/- 10% per 10 foot length

Coir Fiber Wattles shall meet Table 1642-2.

TABLE 1642-2	
100% COIR (COCONUT) FIBERS WATTLE	
Property	Property Value
Minimum Diameter	12 inches
Minimum Density	3.5 pcf +/- 10%
Net Material	Coir Fiber
Net Openings	2 inch x 2 inch
Net Strength	90 lb
Minimum Weight	2.6 pcf +/- 10%

Wattle Barriers shall meet Table 1642-3.

TABLE 1642-3	
100% CURLED WOOD (EXCELSIOR) FIBERS – WATTLE BARRIER	
Property	Property Value
Minimum Diameter	18 inches
Minimum Density	2.9 pcf +/- 10%
Net Material	Synthetic
Net Openings	1 inch x 1 inch
Net Configuration	Totally Encased
Minimum Weight	5 pcf +/- 10%

Coir Fiber Wattle Barriers shall meet Table 1642-4.

TABLE 1642-4	
100% COIR (COCONUT) FIBERS WATTLE BARRIER	
Property	Property Value
Minimum Diameter	18 inches
Minimum Density	5 pcf +/- 10%
Net Material	Coir Fiber
Net Openings	2 inch x 2 inch
Net Strength	90 lb
Minimum Weight	10 pcf +/- 10%

Pages 16-24 & 16-25, Article 1642-5 MEASUREMENT AND PAYMENT, lines 42-47 & lines 1-2, delete and replace with the following:

Wattle will be measured and paid for by the actual number of linear feet of wattles which are installed and accepted. Such price and payment will be full compensation for all work covered by this section, including, but not limited to, furnishing all materials, labor, equipment and incidentals necessary to install the *Wattle*.

Coir Fiber Wattles will be measured and paid for by the actual number of linear feet of coir fiber wattles which are installed and accepted. Such price and payment will be full compensation for all work covered by this section, including, but not limited to, furnishing all materials, labor, equipment and incidentals necessary to install the *Coir Fiber Wattles*.

Wattle Barrier will be measured and paid as the actual number of linear feet of wattle barrier installed and accepted. Such price and payment will be full compensation for all work covered by this provision, including, but not limited to, furnishing all materials, labor, equipment and incidentals necessary to install the *Wattle Barrier*.

Coir Fiber Wattle Barrier will be measured and paid as the actual number of linear feet of coir fiber wattle barrier installed and accepted. Such price and payment will be full compensation for all work covered by this provision, including, but not limited to, furnishing all materials, labor, equipment and incidentals necessary to install the *Coir Fiber Wattle Barrier*.

Page 16-25, Article 1642-5 MEASUREMENT AND PAYMENT, after line 9, delete and replace “ ___ Wattle Check” with “Wattle”.

Page 16-25, Article 1642-5 MEASUREMENT AND PAYMENT, after line 9, delete and replace “ ___ Wattle Barrier” with “Wattle Barrier”.

Page 16-25, Article 1642-5 MEASUREMENT AND PAYMENT, after line 9, add the following:

Pay Item	Pay Unit
Coir Fiber Wattle	Linear Foot
Coir Fiber Wattle Barrier	Linear Foot

STANDARD SPECIAL PROVISION**AVAILABILITY OF FUNDS – TERMINATION OF CONTRACTS**

(5-20-08)(Rev. 1-16-24)

Z-2

General Statute 143C-6-11. (h) Highway Appropriation is hereby incorporated verbatim in this contract as follows:

(h) Amounts Encumbered. – Transportation project appropriations may be encumbered in the amount of allotments made to the Department of Transportation by the Director for the estimated payments for transportation project contract work to be performed in the appropriation fiscal year. The allotments shall be multiyear allotments and shall be based on estimated revenues and shall be subject to the maximum contract authority contained in *General Statute 143C-6-11(c)*. Payment for transportation project work performed pursuant to contract in any fiscal year other than the current fiscal year is subject to appropriations by the General Assembly. Transportation project contracts shall contain a schedule of estimated completion progress, and any acceleration of this progress shall be subject to the approval of the Department of Transportation provided funds are available. The State reserves the right to terminate or suspend any transportation project contract, and any transportation project contract shall be so terminated or suspended if funds will not be available for payment of the work to be performed during that fiscal year pursuant to the contract. In the event of termination of any contract, the contractor shall be given a written notice of termination at least 60 days before completion of scheduled work for which funds are available. In the event of termination, the contractor shall be paid for the work already performed in accordance with the contract specifications.

Payment will be made on any contract terminated pursuant to the special provision in accordance with Subarticle 108-13(D) of the *Standard Specifications*.

STANDARD SPECIAL PROVISION
NCDOT GENERAL SEED SPECIFICATION FOR SEED QUALITY

(5-17-11)

Z-3

Seed shall be sampled and tested by the North Carolina Department of Agriculture and Consumer Services, Seed Testing Laboratory. When said samples are collected, the vendor shall supply an independent laboratory report for each lot to be tested. Results from seed so sampled shall be final. Seed not meeting the specifications shall be rejected by the Department of Transportation and shall not be delivered to North Carolina Department of Transportation warehouses. If seed has been delivered it shall be available for pickup and replacement at the supplier's expense.

Any re-labeling required by the North Carolina Department of Agriculture and Consumer Services, Seed Testing Laboratory, that would cause the label to reflect as otherwise specified herein shall be rejected by the North Carolina Department of Transportation.

Seed shall be free from seeds of the noxious weeds Johnsongrass, Balloonvine, Jimsonweed, Witchweed, Itchgrass, Serrated Tussock, Showy Crotalaria, Smooth Crotalaria, Sicklepod, Sandbur, Wild Onion, and Wild Garlic. Seed shall not be labeled with the above weed species on the seed analysis label. Tolerances as applied by the Association of Official Seed Analysts will NOT be allowed for the above noxious weeds except for Wild Onion and Wild Garlic.

Tolerances established by the Association of Official Seed Analysts will generally be recognized. However, for the purpose of figuring pure live seed, the found pure seed and found germination percentages as reported by the North Carolina Department of Agriculture and Consumer Services, Seed Testing Laboratory will be used. Allowances, as established by the NCDOT, will be recognized for minimum pure live seed as listed on the following pages.

The specifications for restricted noxious weed seed refers to the number per pound as follows:

<u>Restricted Noxious Weed</u>	<u>Limitations per Lb. Of Seed</u>	<u>Restricted Noxious Weed</u>	<u>Limitations per Lb. of Seed</u>
Blessed Thistle	4 seeds	Cornflower (Ragged Robin)	27 seeds
Cocklebur	4 seeds	Texas Panicum	27 seeds
Spurred Anoda	4 seeds	Bracted Plantain	54 seeds
Velvetleaf	4 seeds	Buckhorn Plantain	54 seeds
Morning-glory	8 seeds	Broadleaf Dock	54 seeds
Corn Cockle	10 seeds	Curly Dock	54 seeds
Wild Radish	12 seeds	Dodder	54 seeds
Purple Nutsedge	27 seeds	Giant Foxtail	54 seeds
Yellow Nutsedge	27 seeds	Horsenettle	54 seeds
Canada Thistle	27 seeds	Quackgrass	54 seeds
Field Bindweed	27 seeds	Wild Mustard	54 seeds
Hedge Bindweed	27 seeds		

Seed of Pensacola Bahiagrass shall not contain more than 7% inert matter, Kentucky Bluegrass, Centipede and Fine or Hard Fescue shall not contain more than 5% inert matter whereas a maximum of 2% inert matter will be allowed on all other kinds of seed. In addition, all seed

shall not contain more than 2% other crop seed nor more than 1% total weed seed. The germination rate as tested by the North Carolina Department of Agriculture shall not fall below 70%, which includes both dormant and hard seed. Seed shall be labeled with not more than 7%, 5% or 2% inert matter (according to above specifications), 2% other crop seed and 1% total weed seed.

Exceptions may be made for minimum pure live seed allowances when cases of seed variety shortages are verified. Pure live seed percentages will be applied in a verified shortage situation. Those purchase orders of deficient seed lots will be credited with the percentage that the seed is deficient.

FURTHER SPECIFICATIONS FOR EACH SEED GROUP ARE GIVEN BELOW:

Minimum 85% pure live seed; maximum 1% total weed seed; maximum 2% total other crop seed; maximum 144 restricted noxious weed seed per pound. Seed less than 83% pure live seed will not be approved.

Sericea Lespedeza
Oats (seeds)

Minimum 80% pure live seed; maximum 1% total weed seed; maximum 2% total other crop; maximum 144 restricted noxious weed seed per pound. Seed less than 78% pure live seed will not be approved.

Tall Fescue (all approved varieties)	Bermudagrass
Kobe Lespedeza	Browntop Millet
Korean Lespedeza	German Millet – Strain R
Weeping Lovegrass	Clover – Red/White/Crimson
Carpetgrass	

Minimum 78% pure live seed; maximum 1% total weed seed; maximum 2% total other crop seed; maximum 144 restricted noxious weed seed per pound. Seed less than 76% pure live seed will not be approved.

Common or Sweet Sundangrass

Minimum 76% pure live seed; maximum 1% total weed seed; maximum 2% total other crop seed; maximum 144 restricted noxious weed seed per pound. Seed less than 74% pure live seed will not be approved.

Rye (grain; all varieties)
Kentucky Bluegrass (all approved varieties)
Hard Fescue (all approved varieties)
Shrub (bicolor) Lespedeza

Minimum 70% pure live seed; maximum 1% total weed seed; maximum 2% total other crop seed; maximum 144 noxious weed seed per pound. Seed less than 70% pure live seed will not be approved.

Centipedegrass	Japanese Millet
Crownvetch	Reed Canary Grass
Pensacola Bahiagrass	Zoysia

Creeping Red Fescue

Minimum 70% pure live seed; maximum 1% total weed seed; maximum 2% total other crop seed; maximum 5% inert matter; maximum 144 restricted noxious weed seed per pound.

Barnyard Grass
Big Bluestem
Little Bluestem
Bristly Locust
Birdsfoot Trefoil
Indiangrass
Orchardgrass
Switchgrass
Yellow Blossom Sweet Clover

STANDARD SPECIAL PROVISION
ERRATA

(1-16-24)(Rev. 1-20-26)

Z-4

Revise the *2024 Standard Specifications* as follows:

Division 1

Page 1-36, Subarticle 104-12(B) Evaluation of Proposals, line 21, replace "Design-Build Unit" with "Alternative Delivery Unit".

Page 1-36, Subarticle 104-12(D) Preliminary Review, line 37, replace "Design-Build Unit" with "Alternative Delivery Unit".

Page 1-37, Subarticle 104-12(E) Final Proposal, line 3, replace "Design-Build Unit" with "Alternative Delivery Unit".

Page 1-37, Subarticle 104-12(F) Design-Build VEPs, line 36, replace "Design-Build Unit" with "Alternative Delivery Unit".

Page 1-38, Subarticle 104-12(G) Modifications, line 1, replace "Design-Build Unit" with "Alternative Delivery Unit".

Division 3

Page 3-5, Article 305-2 MATERIALS, after line 16, replace " 1032-3(A)(7)" with "1032-3" and add the item "Galvanized Corrugated Steel Pipe" with Section "1032-3".

Page 3-6, Article 310-2 MATERIALS, after line 9, add the item "Galvanized Corrugated Steel Pipe" with Section "1032-3".

Division 6

Page 6-15, Article 610-1 DESCRIPTION, line 20, replace "The work includes" with "The work includes, but is not limited to,".

Page 6-15, Article 610-1 DESCRIPTION, line 22, replace "applying the tack coat as specified." with "applying the tack coat in accordance with Section 605.".

Page 6-30, Article 610-14 DENSITY ACCEPTANCE, line 39, replace "QC process." with "QC process in accordance with Section 609.".

Page 6-31, Article 610-16 MEASUREMENT AND PAYMENT, line 13, replace "*Hot Mix Asphalt Pavement*" with "*Asphalt Concrete _____ Course, Type _____*".

Page 6-50, Subarticle 661-4(A) Equipment, lines 4-7, replace the first two sentences of the seventh paragraph with the following:

When an erected fixed stringline is utilized for longitudinal profile and cross slope control furnish and erect the necessary guide line for the equipment.

Division 7

Page 7-18, Subarticle 710-10(A) General, lines 7-8, delete “for *Surface Testing Concrete Pavement*” from the last paragraph.

Division 8

Page 8-27, Article 846-1 DESCRIPTION, line 8, delete “4 inch” from the first paragraph.

Division 9

Page 9-17, Article 904-4 MEASUREMENT AND PAYMENT, prior to line 1, replace " Sign Erection, Relocate Type (Ground Mounted)" with “Sign Erection, Relocate Type ___ (Ground Mounted)”.

Division 10

Page 10-51, Article 1024-4 WATER, prior to line 1, delete the “unpopulated blank row” in Table 1024-2 between “Time of set, deviation from control” and “Chloride Ion Content, Max.”.

Page 10-170, Subarticle 1081-1(C) Requirements, line 4, replace "maximum" with “minimum”.

Division 11

Page 11-15, Article 1160-4 MEASUREMENT AND PAYMENT, line 24, replace “Where barrier units are moved more than one” with “Where barrier units are moved more than once”.

Division 15

Page 15-10, Article 1515-4 MEASUREMENT AND PAYMENT, lines 11, replace " All piping" with “All labor, the manhole, other materials, excavation, backfilling, piping”.

Division 16

Page 16-14, Article 1633-5 MEASUREMENT AND PAYMENT, line 20-24 and prior to line 25, delete and replace with the following " *Flocculant* will be measured and paid in accordance with Article 1642-5 applied to the temporary rock silt checks.”

Page 16-3, Article 1609-2 MATERIALS, after line 26, replace "Type 4" with “Type 4a”.

Page 16-25, Article 1644-2 MATERIALS, after line 22, replace "Type 4" with “Type 4a”.

Division 17

Page 17-15, Article 1715-4 MEASUREMENT AND PAYMENT, line 23, delete and replace “1.25” with “1-1/4”.

Page 17-15, Article 1715-4 MEASUREMENT AND PAYMENT, line 24, delete and replace “(1.25” with “, 1-1/4”.

STANDARD SPECIAL PROVISION**PLANT AND PEST QUARANTINES**

(Imported Fire Ant, Guava Root Knot Nematode, Spongy Moth (formerly known as gypsy moth), Witchweed, Cogon Grass, And Any Other Regulated Noxious Weed or Plant Pest)

(3-18-03)(Rev. 3-18-25)

Z-04a

Within Quarantined Area

This project may be within a county regulated for plant and/or pests. If the project or any part of the Contractor's operations is located within a quarantined area, thoroughly clean all equipment prior to moving out of the quarantined area. Comply with federal/state regulations by obtaining a certificate or limited permit for any regulated article moving from the quarantined area.

Originating in a Quarantined County

Obtain a certificate or limited permit issued by the N.C. Department of Agriculture/United States Department of Agriculture. Have the certificate or limited permit accompany the article when it arrives at the project site.

Contact

Contact the N.C. Department of Agriculture/United States Department of Agriculture at 1-800-206-9333, 919-707-3730, or <https://www.ncagr.gov/divisions/plant-industry/plant-protection/plant-industry-plant-pest-quarantines> to determine those specific project sites located in the quarantined area or for any regulated article used on this project originating in a quarantined county.

Regulated Articles Include

1. Soil, sand, gravel, compost, peat, humus, muck, and decomposed manure, separately or with other articles. This includes movement of articles listed above that may be associated with cut/waste, ditch pulling, and shoulder cutting.
2. Plants with roots including grass sod.
3. Plant crowns and roots.
4. Bulbs, corms, rhizomes, and tubers of ornamental plants.
5. Hay, straw, fodder, and plant litter of any kind.
6. Clearing and grubbing debris.
7. Used agricultural cultivating and harvesting equipment.
8. Used earth-moving equipment.
9. Any other products, articles, or means of conveyance of any character, if determined by an inspector present a hazard of spreading imported fire ant, guava root knot nematode, spongy moth (formerly known as gypsy moth), witchweed, cogon grass, or other regulated noxious weed or plant pest.

STANDARD SPECIAL PROVISION

MINIMUM WAGES

(7-21-09)

Z-5

FEDERAL: The Fair Labor Standards Act provides that with certain exceptions every employer shall pay wages at the rate of not less than SEVEN DOLLARS AND TWENTY FIVE CENTS (\$7.25) per hour.

STATE: The North Carolina Minimum Wage Act provides that every employer shall pay to each of his employees, wages at a rate of not less than SEVEN DOLLARS AND TWENTY FIVE CENTS (\$7.25) per hour.

The minimum wage paid to all skilled labor employed on this contract shall be SEVEN DOLLARS AND TWENTY FIVE CENTS (\$7.25) per hour.

The minimum wage paid to all intermediate labor employed on this contract shall be SEVEN DOLLARS AND TWENTY FIVE CENTS (\$7.25) per hour.

The minimum wage paid to all unskilled labor on this contract shall be SEVEN DOLLARS AND TWENTY FIVE CENTS (\$7.25) per hour.

This determination of the intent of the application of this act to the contract on this project is the responsibility of the Contractor.

The Contractor shall have no claim against the Department of Transportation for any changes in the minimum wage laws, Federal or State. It is the responsibility of the Contractor to keep fully informed of all Federal and State Laws affecting his contract.

STANDARD SPECIAL PROVISION**TITLE VI AND NONDISCRIMINATION:**

(6-28-77)(Rev 1/16/2024)

Z-6

The North Carolina Department of Transportation is committed to carrying out the U.S. Department of Transportation's policy of ensuring nondiscrimination in the award and administration of contracts.

The provisions of this section related to United States Department of Transportation (US DOT) Order 1050.2A, Title 49 Code of Federal Regulations (CFR) part 21, 23 United States Code (U.S.C.) 140 and 23 CFR part 200 (or 49 CFR 303, 49 U.S.C. 5332 or 49 U.S.C. 47123) are applicable to all North Carolina Department of Transportation (NCDOT) contracts and to all related subcontracts, material supply, engineering, architectural and other service contracts, regardless of dollar amount. Any Federal provision that is specifically required not specifically set forth is hereby incorporated by reference.

(1) Title VI Assurances (USDOT Order 1050.2A, Appendix A)

During the performance of this contract, the contractor, for itself, its assignees, and successors in interest (hereinafter referred to as the "contractor") agrees as follows:

(a) Compliance with Regulations

The contractor (hereinafter includes consultants) shall comply with the Acts and the Regulations relative to Nondiscrimination in Federally-assisted programs of the U.S. Department of Transportation, Federal Highway Administration (FHWA), as they may be amended from time to time, which are herein incorporated by reference and made a part of this contract.

(b) Nondiscrimination

The contractor, with regard to the work performed by it during the contract, shall not discriminate on the grounds of race, color, or national origin in the selection and retention of subcontractors, including procurements of materials and leases of equipment. The contractor shall not participate directly or indirectly in the discrimination prohibited by the Acts and the Regulations, including employment practices when the contract covers any activity, project, or program set forth in Appendix B of 49 CFR Part 21.

(c) Solicitations for Subcontractors, Including Procurements of Materials and Equipment

In all solicitations, either by competitive bidding, or negotiation made by the contractor for work to be performed under a subcontract, including procurements of materials, or leases of equipment, each potential subcontractor or supplier shall be notified by the contractor of the contractor's obligations under this contract and the Acts and the Regulations relative to Nondiscrimination on the grounds of race, color, or national origin.

(d) Information and Reports

The contractor shall provide all information and reports required by the Acts, the Regulations, and directives issued pursuant thereto and shall permit access to its

books, records, accounts, other sources of information, and its facilities as may be determined by the Recipient or the FHWA to be pertinent to ascertain compliance with such Acts, Regulations, and instructions. Where any information required of a contractor is in the exclusive possession of another who fails or refuses to furnish the information, the contractor shall so certify to the Recipient or the FHWA, as appropriate, and shall set forth what efforts it has made to obtain the information.

(e) Sanctions for Noncompliance:

In the event of a contractor's noncompliance with the Non-discrimination provisions of this contract, the Recipient will impose such contract sanctions as it and/or the FHWA may determine to be appropriate, including, but not limited to:

- (i) Withholding payments to the contractor under the contract until the contractor complies; and/or
- (ii) Cancelling, terminating, or suspending a contract, in whole or in part.

(f) Incorporation of Provisions

The contractor shall include the provisions of paragraphs (a) through (f) in every subcontract, including procurements of materials and leases of equipment, unless exempt by the Acts, the Regulations and directives issued pursuant thereto. The contractor shall take action with respect to any subcontract or procurement as the Recipient or the FHWA may direct as a means of enforcing such provisions including sanctions for noncompliance. Provided, that if the contractor becomes involved in, or is threatened with litigation by a subcontractor, or supplier because of such direction, the contractor may request the Recipient to enter into any litigation to protect the interests of the Recipient. In addition, the contractor may request the United States to enter into the litigation to protect the interests of the United States.

(2) Title VI Nondiscrimination Program (23 CFR 200.5(p))

The North Carolina Department of Transportation (NCDOT) has assured the USDOT that, as a condition to receiving federal financial assistance, NCDOT will comply with Title VI of the Civil Rights Act of 1964 and all requirements imposed by Title 49 CFR part 21 and related nondiscrimination authorities to ensure that no person shall, on the ground of race, color, national origin, limited English proficiency, sex, age, or disability (including religion/creed or income-level, where applicable), be excluded from participation in, be denied the benefits of, or be subjected to discrimination under any programs, activities, or services conducted or funded by NCDOT. Contractors and other organizations under contract or agreement with NCDOT must also comply with Title VI and related authorities, therefore:

- (a) During the performance of this contract or agreement, contractors (e.g., subcontractors, consultants, vendors, prime contractors) are responsible for complying with NCDOT's Title VI Program. Contractors are not required to prepare or submit Title VI Programs. To comply with this section, the prime contractor shall:
 1. Post NCDOT's Notice of Nondiscrimination and the Contractor's own Equal Employment Opportunity (EEO) Policy in conspicuous locations accessible to all employees, applicants and subcontractors on the jobsite.

2. Physically incorporate the required Title VI clauses into all subcontracts on federally-assisted and state-funded NCDOT projects, and ensure inclusion by subcontractors into all lower-tier subcontracts.
 3. Required Solicitation Language. The Contractor shall include the following notification in all solicitations for bids and requests for work or material, regardless of funding source:

“The North Carolina Department of Transportation, in accordance with the provisions of Title VI of the Civil Rights Act of 1964 (78 Stat. 252, 42 U.S.C. §§ 2000d to 2000d-4) and the Regulations, hereby notifies all bidders that it will affirmatively ensure that any contract entered into pursuant to this advertisement, disadvantaged business enterprises will be afforded full and fair opportunity to submit bids in response to this invitation and will not be discriminated against on the grounds of race, color, or national origin in consideration for an award. In accordance with other related nondiscrimination authorities, bidders and contractors will also not be discriminated against on the grounds of sex, age, disability, low-income level, creed/religion, or limited English proficiency in consideration for an award.”
 4. Physically incorporate the FHWA-1273, in its entirety, into all subcontracts and subsequent lower tier subcontracts on Federal-aid highway construction contracts only.
 5. Provide language assistance services (i.e., written translation and oral interpretation), free of charge, to LEP employees and applicants. Contact NCDOT OCR for further assistance, if needed.
 6. For assistance with these Title VI requirements, contact the NCDOT Title VI Nondiscrimination Program at 1-800-522-0453.
- (b) Subrecipients (e.g. cities, counties, LGAs, planning organizations) may be required to prepare and submit a Title VI Plan to NCDOT, including Title VI Assurances and/or agreements. Subrecipients must also ensure compliance by their contractors and subrecipients with Title VI. (23 CFR 200.9(b)(7))
 - (c) If reviewed or investigated by NCDOT, the contractor or subrecipient agrees to take affirmative action to correct any deficiencies found within a reasonable time period, not to exceed 90 calendar days, unless additional time is granted by NCDOT. (23 CFR 200.9(b)(15))
 - (d) The Contractor is responsible for notifying subcontractors of NCDOT’s External Discrimination Complaints Process.
 1. Applicability

Title VI and related laws protect participants and beneficiaries (e.g., members of the public and contractors) from discrimination by NCDOT employees, subrecipients and contractors, regardless of funding source.

2. Eligibility

Any person—or class of persons—who believes he/she has been subjected to discrimination based on race, color, national origin, Limited English Proficiency (LEP), sex, age, or disability (and religion in the context of employment, aviation, or transit) may file a written complaint. The law also prohibits intimidation or retaliation of any sort.

3. Time Limits and Filing Options

Complaints may be filed by the affected individual(s) or a representative and must be filed no later than 180 calendar days after the following:

- (i) The date of the alleged act of discrimination; or
- (ii) The date when the person(s) became aware of the alleged discrimination; or
- (iii) Where there has been a continuing course of conduct, the date on which that conduct was discontinued or the latest instance of the conduct.

Title VI and related discrimination complaints may be submitted to the following entities:

- North Carolina Department of Transportation, Office of Civil Rights, Title VI Program, 1511 Mail Service Center, Raleigh, NC 27699-1511; toll free 1-800-522-0453
- Federal Highway Administration, North Carolina Division Office, 310 New Bern Avenue, Suite 410, Raleigh, NC 27601, 919-747-7010
- US Department of Transportation, Departmental Office of Civil Rights, External Civil Rights Programs Division, 1200 New Jersey Avenue, SE, Washington, DC 20590; 202-366-4070

4. Format for Complaints

Complaints must be in writing and signed by the complainant(s) or a representative, and include the complainant's name, address, and telephone number. Complaints received by fax or e-mail will be acknowledged and processed. Allegations received by telephone will be reduced to writing and provided to the complainant for confirmation or revision before processing. Complaints will be accepted in other languages, including Braille.

5. Discrimination Complaint Form

Contact NCDOT Civil Rights to receive a full copy of the Discrimination Complaint Form and procedures.

6. Complaint Basis

Allegations must be based on issues involving race, color, national origin (LEP), sex, age, disability, or religion (in the context of employment, aviation or transit). "Basis" refers to the complainant's membership in a protected group category.

TABLE 103-1 COMPLAINT BASIS			
Protected Categories	Definition	Examples	Applicable Nondiscrimination Authorities
Race and Ethnicity	An individual belonging to one of the accepted racial groups; or the perception, based usually on physical characteristics that a person is a member of a racial group	Black/African American, Hispanic/Latino, Asian, American Indian/Alaska Native, Native Hawaiian/Pacific Islander, White	Title VI of the Civil Rights Act of 1964; 49 CFR Part 21; 23 CFR 200; 49 U.S.C. 5332(b); 49 U.S.C. 47123. (<i>Executive Order 13166</i>)
Color	Color of skin, including shade of skin within a racial group	Black, White, brown, yellow, etc.	
National Origin (<i>Limited English Proficiency</i>)	Place of birth. Citizenship is not a factor. (<i>Discrimination based on language or a person's accent is also covered</i>)	Mexican, Cuban, Japanese, Vietnamese, Chinese	
Sex	Gender. The sex of an individual. <i>Note: Sex under this program does not include sexual orientation.</i>	Women and Men	1973 Federal-Aid Highway Act; 49 U.S.C. 5332(b); 49 U.S.C. 47123.
Age	Persons of any age	21-year-old person	Age Discrimination Act of 1975 49 U.S.C. 5332(b); 49 U.S.C. 47123.
Disability	Physical or mental impairment, permanent or temporary, or perceived.	Blind, alcoholic, para-amputee, epileptic, diabetic, arthritic	Section 504 of the Rehabilitation Act of 1973; Americans with Disabilities Act of 1990
Religion (in the context of employment) (<i>Religion/ Creed in all aspects of any aviation or transit-related construction</i>)	An individual belonging to a religious group; or the perception, based on distinguishable characteristics that a person is a member of a religious group. In practice, actions taken as a result of the moral and ethical beliefs as to what is right and wrong, which are sincerely held with the strength of traditional religious views. <i>Note: Does not have to be associated with a recognized religious group or church; if an individual sincerely holds to the belief, it is a protected religious practice.</i>	Muslim, Christian, Sikh, Hindu, etc.	Title VII of the Civil Rights Act of 1964; 23 CFR 230; FHWA-1273 Required Contract Provisions. (<i>49 U.S.C. 5332(b); 49 U.S.C. 47123</i>)

(3) Pertinent Nondiscrimination Authorities

During the performance of this contract, the contractor, for itself, its assignees, and successors in interest agrees to comply with the following non-discrimination statutes and authorities, including, but not limited to:

- (a) Title VI of the Civil Rights Act of 1964 (42 U.S.C. § 2000d et seq., 78 stat. 252), (prohibits discrimination on the basis of race, color, national origin); and 49 CFR Part 21.

- (b) The Uniform Relocation Assistance and Real Property Acquisition Policies Act of 1970, (42 U.S.C. § 4601), (prohibits unfair treatment of persons displaced or whose property has been acquired because of Federal or Federal-aid programs and projects);
- (c) Federal-Aid Highway Act of 1973, (23 U.S.C. § 324 et seq.), (prohibits discrimination on the basis of sex);
- (d) Section 504 of the Rehabilitation Act of 1973, (29 U.S.C. § 794 et seq.), as amended, (prohibits discrimination on the basis of disability) and 49 CFR Part 27;
- (e) The Age Discrimination Act of 1975, as amended, (42 U.S.C. § 6101 et seq.), (prohibits discrimination on the basis of age);
- (f) Airport and Airway Improvement Act of 1982, (49 USC § 471, Section 47123), as amended, (prohibits discrimination based on race, creed, color, national origin, or sex);
- (g) The Civil Rights Restoration Act of 1987, (PL 100-209), (Broadened the scope, coverage and applicability of Title VI of the Civil Rights Act of 1964, The Age Discrimination Act of 1975 and Section 504 of the Rehabilitation Act of 1973, by expanding the definition of the terms "programs or activities" to include all of the programs or activities of the Federal-aid recipients, sub-recipients and contractors, whether such programs or activities are Federally funded or not);
- (h) Titles II and III of the Americans with Disabilities Act, which prohibit discrimination on the basis of disability in the operation of public entities, public and private transportation systems, places of public accommodation, and certain testing entities (42 U.S.C. §§ 12131-12189) as implemented by Department of Transportation regulations at 49 C.F.R. parts 37 and 38;
- (i) The Federal Aviation Administration's Nondiscrimination statute (49 U.S.C. § 47123) (prohibits discrimination on the basis of race, color, national origin, and sex);
- (j) Executive Order 12898, Federal Actions to Address Environmental Justice in Minority Populations and Low-Income Populations, which ensures Nondiscrimination against minority populations by discouraging programs, policies, and activities with disproportionately high and adverse human health or environmental effects on minority and low-income populations;
- (k) Executive Order 13166, Improving Access to Services for Persons with Limited English Proficiency, and resulting agency guidance, national origin discrimination includes discrimination because of Limited English proficiency (LEP). To ensure compliance with Title VI, you must take reasonable steps to ensure that LEP persons have meaningful access to your programs (70 Fed. Reg. at 74087 to 74100);
- (l) Title IX of the Education Amendments of 1972, as amended, which prohibits you from discriminating because of sex in education programs or activities (20 U.S.C. 1681 et seq).
- (m) Title VII of the Civil Rights Act of 1964 (42 U.S.C. § 2000e et seq., Pub. L. 88-352), (prohibits employment discrimination on the basis of race, color, religion, sex, or national origin).

(4) Additional Title VI Assurances

***The following Title VI Assurances (Appendices B, C and D) shall apply, as applicable*

- (a) Clauses for Deeds Transferring United States Property (1050.2A, Appendix B)

The following clauses will be included in deeds effecting or recording the transfer of real property, structures, or improvements thereon, or granting interest therein from the United States pursuant to the provisions of Assurance 4.

NOW, THEREFORE, the U.S. Department of Transportation as authorized by law and upon the condition that the North Carolina Department of Transportation (NCDOT) will accept title to the lands and maintain the project constructed thereon in accordance with the North Carolina General Assembly, the Regulations for the Administration of the Federal-Aid Highway Program, and the policies and procedures prescribed by the Federal Highway Administration of the U.S. Department of Transportation in accordance and in compliance with all requirements imposed by Title 49, Code of Federal Regulations, U.S. Department of Transportation, Subtitle A, Office of the Secretary, Part 21, Nondiscrimination in Federally-assisted programs of the U.S. Department of Transportation pertaining to and effectuating the provisions of Title VI of the Civil Rights Act of 1964 (78 Stat. 252; 42 U.S.C. § 2000d to 2000d-4), does hereby remise, release, quitclaim and convey unto the NCDOT all the right, title and interest of the U.S. Department of Transportation in and to said lands described in Exhibit A attached hereto and made a part hereof.

(HABENDUM CLAUSE)

TO HAVE AND TO HOLD said lands and interests therein unto the North Carolina Department of Transportation (NCDOT) and its successors forever, subject, however, to the covenants, conditions, restrictions and reservations herein contained as follows, which will remain in effect for the period during which the real property or structures are used for a purpose for which Federal financial assistance is extended or for another purpose involving the provision of similar services or benefits and will be binding on the NCDOT, its successors and assigns.

The NCDOT, in consideration of the conveyance of said lands and interests in lands, does hereby covenant and agree as a covenant running with the land for itself, its successors and assigns, that (1) no person will on the grounds of race, color, or national origin, be excluded from participation in, be denied the benefits of, or be otherwise subjected to discrimination with regard to any facility located wholly or in part on, over, or under such lands hereby conveyed [,] [and]* (2) that the NCDOT will use the lands and interests in lands and interests in lands so conveyed, in compliance with all requirements imposed by or pursuant to Title 49, Code of Federal Regulations, U.S. Department of Transportation, Subtitle A, Office of the Secretary, Part 21, Non-discrimination in Federally-assisted programs of the U.S. Department of Transportation, Effectuation of Title VI of the Civil Rights Act of 1964, and as said Regulations and Acts may be amended [, and (3) that in the event of breach of any of the above-mentioned nondiscrimination conditions, the Department will have a right to enter or re-enter said lands and facilities on said land, and that above described land and facilities will thereon revert to and vest in and become the absolute property of the U.S. Department of Transportation and its assigns as such interest existed prior to this instruction].*

(*Reverter clause and related language to be used only when it is determined that such a clause is necessary in order to make clear the purpose of Title VI.)

(b) Clauses for Transfer of Real Property Acquired or Improved Under the Activity, Facility, or Program (1050.2A, Appendix C)

The following clauses will be included in deeds, licenses, leases, permits, or similar instruments entered into by the North Carolina Department of Transportation (NCDOT) pursuant to the provisions of Assurance 7(a):

1. The (grantee, lessee, permittee, etc. as appropriate) for himself/herself, his/her heirs, personal representatives, successors in interest, and assigns, as a part of the consideration hereof, does hereby covenant and agree [in the case of deeds and leases add "as a covenant running with the land"] that:
 - (i.) In the event facilities are constructed, maintained, or otherwise operated on the property described in this (deed, license, lease, permit, etc.) for a purpose for which a U.S. Department of Transportation activity, facility, or program is extended or for another purpose involving the provision of similar services or benefits, the (grantee, licensee, lessee, permittee, etc.) will maintain and operate such facilities and services in compliance with all requirements imposed by the Acts and Regulations (as may be amended) such that no person on the grounds of race, color, or national origin, will be excluded from participation in, denied the benefits of, or be otherwise subjected to discrimination in the use of said facilities.
2. With respect to licenses, leases, permits, etc., in the event of breach of any of the above Nondiscrimination covenants, the NCDOT will have the right to terminate the (lease, license, permit, etc.) and to enter, re-enter, and repossess said lands and facilities thereon, and hold the same as if the (lease, license, permit, etc.) had never been made or issued. *
3. With respect to a deed, in the event of breach of any of the above Nondiscrimination covenants, the NCDOT will have the right to enter or re-enter the lands and facilities thereon, and the above described lands and facilities will there upon revert to and vest in and become the absolute property of the NCDOT and its assigns. *

(*Reverter clause and related language to be used only when it is determined that such a clause is necessary to make clear the purpose of Title VI.)

(c) Clauses for Construction/Use/Access to Real Property Acquired Under the Activity, Facility or Program (1050.2A, Appendix D)

The following clauses will be included in deeds, licenses, permits, or similar instruments/ agreements entered into by the North Carolina Department of Transportation (NCDOT) pursuant to the provisions of Assurance 7(b):

1. The (grantee, licensee, permittee, etc., as appropriate) for himself/herself, his/her heirs, personal representatives, successors in interest, and assigns, as a part of the consideration hereof, does hereby covenant and agree (in the case of deeds and leases add, "as a covenant running with the land") that (1) no person on the ground of race, color, or national origin, will be excluded from participation in, denied the benefits of, or be otherwise subjected to discrimination in the use of said facilities, (2) that in the construction of any improvements on, over, or under such land, and the furnishing of services thereon, no person on the ground of race, color, or national origin, will be excluded from participation in, denied the benefits of, or otherwise be subjected to discrimination, (3) that the (grantee, licensee, lessee, permittee, etc.) will use the premises in compliance with all other requirements imposed by or pursuant to the Acts and Regulations, as amended, set forth in this Assurance.
2. With respect to (licenses, leases, permits, etc.), in the event of breach of any of the above Non-discrimination covenants, the NCDOT will have the right to terminate the (license, permit, etc., as appropriate) and to enter or re-enter and repossess said land and the facilities thereon, and hold the same as if said (license, permit, etc., as appropriate) had never been made or issued. *
3. With respect to deeds, in the event of breach of any of the above Nondiscrimination covenants, the NCDOT will there upon revert to and vest in and become the absolute property of the NCDOT and its assigns. *

(*Reverter clause and related language to be used only when it is determined that such a clause is necessary to make clear the purpose of Title VI.)

STANDARD SPECIAL PROVISION**ON-THE-JOB TRAINING**

(10-16-07) (Rev. 4-21-15)

Z-10

Description

The North Carolina Department of Transportation will administer a custom version of the Federal On-the-Job Training (OJT) Program, commonly referred to as the Alternate OJT Program. All contractors (existing and newcomers) will be automatically placed in the Alternate Program. Standard OJT requirements typically associated with individual projects will no longer be applied at the project level. Instead, these requirements will be applicable on an annual basis for each contractor administered by the OJT Program Manager.

On the Job Training shall meet the requirements of 23 CFR 230.107 (b), 23 USC – Section 140, this provision and the On-the-Job Training Program Manual.

The Alternate OJT Program will allow a contractor to train employees on Federal, State and privately funded projects located in North Carolina. However, priority shall be given to training employees on NCDOT Federal-Aid funded projects.

Minorities and Women

Developing, training and upgrading of minorities and women toward journeyman level status is a primary objective of this special training provision. Accordingly, the Contractor shall make every effort to enroll minority and women as trainees to the extent that such persons are available within a reasonable area of recruitment. This training commitment is not intended, and shall not be used, to discriminate against any applicant for training, whether a member of a minority group or not.

Assigning Training Goals

The Department, through the OJT Program Manager, will assign training goals for a calendar year based on the contractors' past three years' activity and the contractors' anticipated upcoming year's activity with the Department. At the beginning of each year, all contractors eligible will be contacted by the Department to determine the number of trainees that will be assigned for the upcoming calendar year. At that time the Contractor shall enter into an agreement with the Department to provide a self-imposed on-the-job training program for the calendar year. This agreement will include a specific number of annual training goals agreed to by both parties. The number of training assignments may range from 1 to 15 per contractor per calendar year. The Contractor shall sign an agreement to fulfill their annual goal for the year.\

Training Classifications

The Contractor shall provide on-the-job training aimed at developing full journeyman level workers in the construction craft/operator positions. Preference shall be given to providing training in the following skilled work classifications:

Equipment Operators	Office Engineers
Truck Drivers	Estimators
Carpenters	Iron / Reinforcing Steel Workers
Concrete Finishers	Mechanics
Pipe Layers	Welders

The Department has established common training classifications and their respective training requirements that may be used by the contractors. However, the classifications established are not all-inclusive. Where the training is oriented toward construction applications, training will be allowed in lower-level management positions such as office engineers and estimators. Contractors shall submit new classifications for specific job functions that their employees are performing. The Department will review and recommend for acceptance to FHWA the new classifications proposed by contractors, if applicable. New classifications shall meet the following requirements:

Proposed training classifications are reasonable and realistic based on the job skill classification needs, and

The number of training hours specified in the training classification is consistent with common practices and provides enough time for the trainee to obtain journeyman level status.

The Contractor may allow trainees to be trained by a subcontractor provided that the Contractor retains primary responsibility for meeting the training and this provision is made applicable to the subcontract. However, only the Contractor will receive credit towards the annual goal for the trainee.

Where feasible, 25 percent of apprentices or trainees in each occupation shall be in their first year of apprenticeship or training. The number of trainees shall be distributed among the work classifications on the basis of the contractor's needs and the availability of journeymen in the various classifications within a reasonable area of recruitment.

No employee shall be employed as a trainee in any classification in which they have successfully completed a training course leading to journeyman level status or in which they have been employed as a journeyman.

Records and Reports

The Contractor shall maintain enrollment, monthly and completion reports documenting company compliance under these contract documents. These documents and any other information as requested shall be submitted to the OJT Program Manager.

Upon completion and graduation of the program, the Contractor shall provide each trainee with a certification Certificate showing the type and length of training satisfactorily completed.

Trainee Interviews

All trainees enrolled in the program will receive an initial and Trainee/Post graduate interview conducted by the OJT program staff.

Trainee Wages

Contractors shall compensate trainees on a graduating pay scale based upon a percentage of the prevailing minimum journeyman wages (Davis-Bacon Act). Minimum pay shall be as follows:

60 percent	of the journeyman wage for the first half of the training period
75 percent	of the journeyman wage for the third quarter of the training period
90 percent	of the journeyman wage for the last quarter of the training period

In no instance shall a trainee be paid less than the local minimum wage. The Contractor shall adhere to the minimum hourly wage rate that will satisfy both the NC Department of Labor (NCDOL) and the Department.

Achieving or Failing to Meet Training Goals

The Contractor will be credited for each trainee employed by him on the contract work who is currently enrolled or becomes enrolled in an approved program and who receives training for at least 50 percent of the specific program requirement. Trainees will be allowed to be transferred between projects if required by the Contractor's scheduled workload to meet training goals.

If a contractor fails to attain their training assignments for the calendar year, they may be taken off the NCDOT's Bidders List.

Measurement and Payment

No compensation will be made for providing required training in accordance with these contract documents.

U-3609B

GT-1.1

Wayne County

STANDARD SHORING:

(1-16-24)

Description

Standard shoring includes standard temporary shoring and standard temporary mechanically stabilized earth (MSE) walls. At the Contractor’s option, use standard shoring as noted in the plans or as directed. When using standard shoring, a temporary shoring design submittal is not required. Construct standard shoring based on actual elevations and shoring dimensions in accordance with the contract and Geotechnical Standard Detail No. 1801.01 or 1801.02.

Define “standard temporary shoring” as cantilever shoring that meets the standard temporary shoring detail (Geotechnical Standard Detail No. 1801.01). Define “standard temporary wall” as a temporary MSE wall with geotextile or geogrid reinforcement that meets the standard temporary wall detail (Geotechnical Standard Detail No. 1801.02). Define “standard temporary geotextile wall” as a standard temporary wall with geotextile reinforcement and “standard temporary geogrid wall” as a standard temporary wall with geogrid reinforcement.

Provide positive protection for standard shoring at locations shown in the plans and as directed. See *Temporary Shoring* provision for positive protection types and definitions.

Materials

Refer to the *Standard Specifications*.

Item	Section
Concrete Barrier Materials	1170-2
Flowable Fill, Excavatable	1000-7
Geosynthetics	1056
Grout, Type 1	1003
Portland Cement Concrete, Class A	1000
Select Materials	1016
Steel Beam Guardrail Materials	862-2
Steel Sheet Piles and H-Piles	1084
Untreated Timber	1082-2
Welded Wire Reinforcement	1070-3

Provide Type 6 material certifications for shoring materials. Use Class IV select material for temporary guardrail. Use Class A concrete that meets Article 450-2 of the *Standard Specifications* or Type 1 grout for drilled-in piles.

Based on actual shoring height, positive protection, groundwater elevation, slope or surcharge case and traffic impact at each standard temporary shoring location, use sheet piles with the minimum required section modulus or H-piles with the sizes shown in Geotechnical Standard Detail No. 1801.01. Use untreated timber with a thickness of at least 3" and a bending stress of at least 1,000 psi for timber lagging.

(A) Shoring Backfill

Use Class II, Type 1, Class III, Class V or Class VI select material or material that meets AASHTO M 145 for soil classification A-2-4 with a maximum PI of 6 for shoring backfill except do not use the following:

- (1) A-2-4 soil for backfill around culverts,

U-3609B

GT-1.2

Wayne County

- (2) A-2-4 soil in the reinforced zone of standard temporary walls with a back slope and
- (3) Class VI select material in the reinforced zone of standard temporary geotextile walls.

(B) Standard Temporary Walls

Use welded wire reinforcement for welded wire facing, struts and wires with the dimensions and minimum wire sizes shown in Geotechnical Standard Detail No. 1801.02. Provide Type 2 geotextile for separation and retention geotextiles. Do not use more than 4 different reinforcement strengths for each standard temporary wall.

(1) Geotextile Reinforcement

Provide Type 4a geotextile for geotextile reinforcement except for the ultimate tensile strength. Based on actual wall height, groundwater elevation, slope or surcharge case and shoring backfill to be used in the reinforced zone at each standard temporary geotextile wall location, provide geotextiles with ultimate tensile strengths as shown in Geotechnical Standard Detail No. 1801.02.

(2) Geogrid Reinforcement

Use geogrids for geogrid reinforcement with a roll width of at least 4 ft and an “approved” status code in accordance with the NCDOT Geosynthetic Reinforcement Evaluation Program. The list of approved geogrids is available from:

connect.ncdot.gov/resources/Geological/Pages/Products.aspx

Based on actual wall height, groundwater or flood elevation, slope or surcharge case and shoring backfill to be used in the reinforced zone at each standard temporary geogrid wall location, provide geogrids for geogrid reinforcement with short-term design strengths as shown in Geotechnical Standard Detail No. 1801.02. Geogrids are approved for short-term design strengths (3-year design life) in the machine direction (MD) and cross-machine direction (CD) based on material type. Define material type from the website above for shoring backfill as follows:

Material Type	Shoring Backfill
Borrow	A-2-4 Soil
Fine Aggregate	Class II, Type 1 or Class III Select Material
Coarse Aggregate	Class V or VI Select Material

Preconstruction Requirements

(A) Concrete Barrier

Define “clear distance” behind concrete barrier as the horizontal distance between the barrier and edge of pavement. The minimum required clear distance for concrete barrier is shown in the plans. At the Contractor’s option or if the minimum required clear distance is not available, set concrete barrier next to and up against traffic side of standard shoring except for barrier above standard temporary walls. Concrete barrier with the minimum required clear distance is required above standard temporary walls.

(B) Temporary Guardrail

U-3609B

GT-1.3

Wayne County

Define “clear distance” behind temporary guardrail as the horizontal distance between guardrail posts and standard shoring. At the Contractor’s option or if clear distance for standard temporary shoring is less than 4 ft, attach guardrail to traffic side of shoring as shown in the plans. Place ABC in clear distance and around guardrail posts instead of pavement. Do not use temporary guardrail above standard temporary walls.

(C) Standard Shoring Selection Forms

Before beginning standard shoring construction, survey existing ground elevations in the vicinity of standard shoring locations to determine actual shoring or wall heights (H). Submit a standard shoring selection form for each location at least 7 days before starting standard shoring construction. Standard shoring selection forms are available from:

connect.ncdot.gov/resources/Geological/Pages/Geotech_Forms_Details.aspx

Construction Methods

Construct standard shoring in accordance with the *Temporary Shoring* provision.

(A) Standard Temporary Shoring Installation

Based on actual shoring height, positive protection, groundwater elevation, slope or surcharge case and traffic impact at each standard temporary shoring location, install piles with the minimum required embedment and extension for each shoring section in accordance with Geotechnical Standard Detail No. 1801.01. For concrete barrier above and next to standard temporary shoring and temporary guardrail above and attached to standard temporary shoring, use “surcharge case with traffic impact” in accordance with Geotechnical Standard Detail No. 1801.01. Otherwise, use “slope or surcharge case with no traffic impact” in accordance with Geotechnical Standard Detail No. 1801.01. If refusal is reached before driven piles attain the minimum required embedment, use drilled-in H-piles with timber lagging for standard temporary shoring.

(B) Standard Temporary Walls Installation

Based on actual wall height, groundwater elevation, slope or surcharge case, geotextile or geogrid reinforcement and shoring backfill in the reinforced zone at each standard temporary wall location, construct walls with the minimum required reinforcement length and number of reinforcement layers for each wall section in accordance with Geotechnical Standard Detail No. 1801.02. For standard temporary walls with pile foundations in the reinforced zone, drive piles through reinforcement after constructing temporary walls.

For standard temporary walls with interior angles less than 90°, wrap geosynthetics at acute corners as directed by the Engineer. Place geosynthetics as shown in Geotechnical Standard Detail No. 1801.02. Place separation geotextiles between shoring backfill and backfill, natural ground or culverts along the sides of the reinforced zone perpendicular to the wall face. For Class V or VI select material in the reinforced zone, place separation geotextiles between shoring backfill and backfill or natural ground on top of and at the back of the reinforced zone.

Measurement and Payment

Standard shoring will be measured and paid in accordance with the *Temporary Shoring* provision.

U-3609B

GT-1.4

Wayne County



Signed by:

W. Scott Hunsberger 1/7/2026

5A469AC80FCD49E...

**PROJECT SPECIAL PROVISIONS
GEOENVIRONMENTAL**

CONTAMINATED SOIL (1/7/2026)

The Contractor's attention is directed to the fact that soil contaminated with petroleum hydrocarbon compounds exist within the project area. The known areas of contamination are indicated on corresponding plans sheets. Information relating to these contaminated areas, sample locations, and investigation reports will be available at the following web address by navigating to the correct letting year and month then selecting, "Plans and Proposals", "U-3609B", "Individual Sheets/520 GeoEnvironmental":

<http://dotw-xfer01.dot.state.nc.us/dsplan/>

Petroleum contaminated soil may be encountered during any earthwork activities on the project. The Contractor shall only excavate those soils that the Engineer designates necessary to complete a particular task. The Engineer shall determine if soil is contaminated based on areas shown on the plans, petroleum odors, and unusual soil staining. Contaminated soil not required to be excavated is to remain in place and undisturbed. Undisturbed soil shall remain in place, whether contaminated or not. The Contractor shall transport all contaminated soil excavated from the project to a facility licensed to accept contaminated soil.

In the event that a stockpile is needed, the stockpile shall be created within the property boundaries of the source material and in accordance with the Diagram for Temporary Containment and Treatment of Petroleum-Contaminated Soil per North Carolina Department of Environmental Quality's (NCDEQ) Division of Waste Management UST Section GUIDELINES FOR EX SITU PETROLEUM CONTAMINATED SOIL REMEDIATION. If the volume of contaminated material exceeds available space on site, the Contractor shall obtain a permit from the NCDEQ UST Section's Regional Office for off-site temporary storage. The Contractor shall provide copies of disposal manifests completed per the disposal facilities requirements and weigh tickets to the Engineer.

Measurement and Payment:

The quantity of contaminated soil hauled and disposed of shall be the actual number of tons of material, which has been acceptably transported and weighed with certified scales as documented by disposal manifests and weigh tickets. The quantity of contaminated soil, measured as provided above, shall be paid for at the contract unit price per ton for "Hauling and Disposal of Petroleum Contaminated Soil".

The above price and payment shall be full compensation for all work covered by this section, including, but not limited to stockpiling, loading, transportation, weighing, laboratory testing, disposal, equipment, decontamination of equipment, labor, and personal protective equipment.

Payment shall be made under:

Pay Item

Hauling and Disposal of Petroleum Contaminated Soil

Pay Unit

Ton

DocuSigned by
Ethan J. Caldwell
E9A1CFAC49A24
01/07/2026





Signed by:

Matthew V. Springer

BC60F6E8B584403...

06/17/2025

YIELD LINES PAVEMENT MARKING:

(1-15-24)(Rev. 6-17-25)

Description

Install yield lines in accordance with this special provision, Section 1205 of the *Standard Specifications* and as directed by the Engineer.

Materials

Refer to Division 10 of the *Standard Specifications*.

Item

Pavement Markings

Section

1087

The material for yield line pavement markings shall be thermoplastic, integrated multipolymer, polyurea, type III cold applied plastic, or heated-in-place thermoplastic. Paint may be used for temporary yield line pavement markings.

Application

Refer to Section 1205 of the *Standard Specifications* and refer to Division 12 of the *Roadway Standard Drawings* on application of products used for yield lines. Refer to the integrated multipolymer (IMP) pavement marking special provision found elsewhere in this contract as applicable. Yield lines shall be a row of solid white isosceles triangles with 3 to 12 inches between each one, 12 to 24 inches in width, with a height 1.5 times the width. Yield lines shall point towards traffic, and they shall be placed at least 4 feet before the nearest controlled crosswalk. For unsignalized midblock crosswalks, yield lines shall be placed with the Yield Here to Pedestrians sign located 20 to 50 feet in advance of the crosswalk. Yield lines are not symbols or characters.

Measurement and Payment

Yield Line _____ Pavement Marking, __", __mils (for thermoplastic, integrated multipolymer, polyurea and heated-in-place thermoplastic material), *Yield Line Pavement Marking, Type III (___")* (for Type 3 cold applied plastic material), or *Yield Line Pavement Marking, ___"* (for paint material) will be measured and paid as the actual number of linear feet of pavement marking lines satisfactorily placed and accepted by the Engineer. The quantity of lines will be the summation of the linear feet of solid line measured end-to-end of the line.

Payment will be made under:

Pay Item

Yield Line _____ Pavement Marking, __", __mils

Yield Line Cold Applied Plastic Pavement Marking, Type III (___")

Yield Line Paint Pavement Marking, ___"

Pay Unit

Linear Feet

Linear Feet

Linear Feet

Project: U-3609B

UC-1

County: Wayne

PROJECT SPECIAL PROVISIONS

Utility Construction

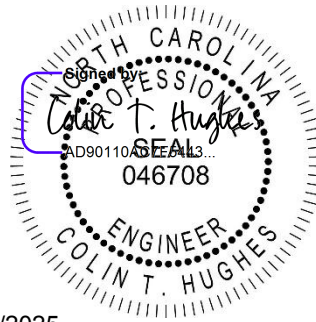

9/19/2025

<p>DOCUMENT NOT CONSIDERED FINAL UNLESS ALL SIGNATURES COMPLETED</p>

Colin T. Hughes, PE
 STV Engineers, Inc.
 2151 Hawkins Street, Suite 1400
 Charlotte, NC 28203
 NC License Number F-0991

Where brand names and model numbers are specified in these Special Provisions or in the plans, the cited examples are used only to denote the quality standard of product desired and do not restrict bidders to a specific brand, make, or manufacturer. They are provided to set forth the general style, type, character, and quality of the product desired. Equivalent products will be acceptable.

The provisions contained within these Utilities Construction Project Special Provisions modify the *Standard Specifications* only for materials used and work performed constructing water or sewer facilities owned by the City of Goldsboro.

Revise the 2024 *Standard Specifications* as follows:

Page 15-1, Sub-article 1500-2 Cooperation with the Utility Owner, paragraph 2: add the following sentences:

The utility owner is the City of Goldsboro. The contact person is Jonathan Perry, Engineering Manager, and can be reached by phone at (919) 580-4317.

100% PROJECT SPECIAL PROVISIONS

Utilities by Others

**General:**

The following utility companies have facilities that will be in conflict with the construction of this project:

- A) Duke Energy - Power**
- B) PNG - Gas**
- C) Eastern Wayne Sanitary Water - Water**
- D) Fork Township Sanitary Water - Water**
- E) AT&T - Communications**
- F) Spectrum - Communications**
- G) Conterra - Communications**

The conflicting facilities of these concerns will be adjusted prior to the date of availability, unless otherwise noted and are therefore listed in these special provisions for the benefit of the Contractor. All utility work listed herein will be done by the utility owners. All utilities are shown on the plans from the best available information.

The Contractor's attention is directed to Article 105-8 of the 2024 *Standard Specifications*.

Utilities Requiring Adjustment:

Utility relocations are shown on the Utilities by Others Plans.

A) Duke Energy - Power

- 1) Contact person for Duke Energy is Andrew Thomas at (919) 573-6777 or AVThomas@pike.com.

B) PNG - Gas

- 1) Contact person for PNG is Eddie Foy (Buddy) at (910) 548-5439 or eddie.foy@duke-energy.com

C) Eastern Wayne Sanitary Water - Water

- 1) Contact person for Eastern Wayne Sanitary Water is Trey Gurley at (919) 736-7630 or deg@mcdavid-inc.com.

100% PROJECT SPECIAL PROVISIONS

Utilities by Others

C) Fork Township Sanitary Water - Water

- 1) Contact person for Fork Township Sanitary Water is Trey Gurley at (919) 736-7630 or deg@mcdavid-inc.com.

D) AT&T - Communications

- 1) Contact person for AT&T is Brandt Vickers at (919) 758-6298 or cv8347@att.com

E) Spectrum - Communications

- 1) Contact person for Spectrum is Chris Mingle at (919) 654-4001 or chris.mingle@charter.com.

F) Conterra - Communications

- 1) Contact person for Conterra is Ryan McCumberat (989) 240-1739 or R.McCumber@goACP.com.

100% PROJECT SPECIAL PROVISIONS

Utilities by Others

Additional Note for Structures Requiring Adjustment:

Contractor will coordinate with utilities to adjust handholes, as needed, to accommodate proposed sidewalks.

**Project Special Provisions
Erosion Control**

STABILIZATION REQUIREMENTS:

(4-30-2019)(Rev. 1-21-25)

Stabilization for this project shall comply with the time frame guidelines as specified by the NCG-010000 general construction permit issued by the North Carolina Department of Environmental Quality Division of Energy, Mineral and Land Resources. Temporary or permanent ground cover stabilization shall occur within the following time frames from the last land-disturbing activity:

- Stabilize perimeter dikes, swales, ditches, and perimeter slopes within 7 calendar days.
- Stabilize high quality water (HQW) zones within 7 calendar days.
- Stabilize slopes steeper than 3:1 within 7 calendar days.
 - If slopes are 10 feet or less in length and are not steeper than 2:1, 14 calendar days are allowed.
- Stabilize slopes 3:1 to 4:1 within 14 calendar days.
 - 7 calendar days for slopes greater than 50 feet in length and with slopes steeper than 4:1.
 - 7 calendar days for perimeter dikes, swales, ditches, perimeter slopes, and HQW Zones.
- Stabilize areas with slopes flatter than 4:1 within 14 calendar days.
 - 7 calendar days for perimeter dikes, swales, ditches, perimeter slopes, and HQW Zones.

The stabilization timeframe for High Quality Water (HQW) Zones shall be 7 calendar days with no exceptions for slope grades or lengths. High Quality Water Zones (HQW) Zones are defined by North Carolina Administrative Code 15A NCAC 04A.0105 (25). Temporary and permanent ground cover stabilization shall be achieved in accordance with the provisions in this contract and as directed.

SEEDING AND MULCHING:

(East)

The kinds of seed and fertilizer, and the rates of application of seed, fertilizer, and limestone, shall be as stated below. During periods of overlapping dates, the kind of seed to be used shall be determined. All rates are in pounds per acre.

All Roadway Areas

March 1 - August 31

50# Tall Fescue
 10# Centipede
 25# Bermudagrass (hulled)
 500# Fertilizer
 4000# Limestone

September 1 - February 28

50# Tall Fescue
 10# Centipede
 35# Bermudagrass (unhulled)
 500# Fertilizer
 4000# Limestone

Waste and Borrow Locations

March 1 – August 31

75#	Tall Fescue
25#	Bermudagrass (hulled)
500#	Fertilizer
4000#	Limestone

September 1 - February 28

75#	Tall Fescue
35#	Bermudagrass (unhulled)
500#	Fertilizer
4000#	Limestone

Note: 50# of Bahiagrass may be substituted for either Centipede or Bermudagrass only upon Engineer's request.

Approved Tall Fescue Cultivars

06 Dust	Escalade	Kalahari	Serengeti
2 nd Millennium	Essential	Kitty Hawk 2000	Shelby
3 rd Millennium	Evergreen 2	Legitimate	Shenandoah III
Avenger	Faith	Lexington	Shenandoah Elite
Bar Fa	Falcon IV	LifeGuard	Sheridan
Barlexas	Falson NG	LSD	Sidewinder
Barlexas II	Falcon V	Magellan	Signia
Barrera	Fat Cat	Masterpiece	Silver Hawk
Barrington	Fesnova	Millennium SRP	Skyline
Barrobusto	Fidelity	Monet	Solara
Barvado	Finelawn Elite	Mustang 4	Southern Choice II
Biltmore	Finelawn Xpress	Naturally Green	Speedway
Bingo	Finesse II	Ninja 2	Spyder LS
Bizem	Firebird	Ol' Glory	Sunset Gold
Black Tail	Firecracker LS	Padre	Taccoa
Blackwatch	Firenza	Patagonia	Tahoe II
Blade Runner II	Five Point	Pedigree	Talladega
Bonsai	Focus	Picasso	Tanzania
Braveheart	Forte	Piedmont	Temple
Bravo	Garrison	Plantation	Terrano
Bullseye	Gazelle II	Proseeds 5301	Thor
Cannavaro	GLX Aced	Prospect	Thunderstruck
Catalyst	Gold Medallion	Quest	Titanium LS
Cayenne	Grande 3	RainDance	Titan LTD
Cezanne RZ	Greenbrooks	Raptor II	Tracer
Chipper	Greenkeeper	Rebel IV	Traverse SRP
Cochise IV	Gremlin	Rebel Exeda	Trio
Constitution	Greystone	Rebel Sentry	Tulsa Time
Corgi	Guardian 21	Regenerate	Turbo
Corona	Guardian 41	Regiment II	Turbo RZ
Coyote	Hemi	Rembrandt	Tuxedo

Cumberland	Honky Tonk	Rendition	Ultimate
Darlington	Hot Rod	Reunion	Umbrella
DaVinci	Hunter	Rhambler 2 SRP	Van Gogh
Desire	Inferno	Riverside	Venture
Diablo	Integrity	RNP	Watchdog
Dominion	Jaguar 3	Rocket	Wolfpack II
Dynamic	Jamboree	Saltillo	Xtremegreen
Dynasty	Justice	Scorpion	

On cut and fill slopes 2:1 or steeper Centipede shall be applied at the rate of 5 pounds per acre and add 20# of Sericea Lespedeza from January 1 - December 31.

Fertilizer shall be 10-20-20 analysis. A different analysis of fertilizer may be used provided the 1-2-2 ratio is maintained and the rate of application adjusted to provide the same amount of plant food as a 10-20-20 analysis and as directed.

Native Grass Seeding and Mulching (East)

Native Grass Seeding and Mulching shall be performed on the disturbed areas of wetlands and riparian areas, and adjacent to Stream Relocation construction within a 50 foot zone on both sides of the stream or depression, measured from top of stream bank or center of depression. The stream bank of the stream relocation shall be seeded by a method that does not alter the typical cross section of the stream bank. Native Grass Seeding and Mulching shall also be performed in the permanent soil reinforcement mat section of preformed scour holes, and in other areas as directed.

The kinds of seed and fertilizer, and the rates of application of seed, fertilizer, and limestone, shall be as stated below. During periods of overlapping dates, the kind of seed to be used shall be determined. All rates are in pounds per acre.

March 1 - August 31		September 1 - February 28	
18#	Creeping Red Fescue	18#	Creeping Red Fescue
6#	Indiangrass	6#	Indiangrass
8#	Little Bluestem	8#	Little Bluestem
4#	Switchgrass	4#	Switchgrass
25#	Browntop Millet	35#	Rye Grain
500#	Fertilizer	500#	Fertilizer
4000#	Limestone	4000#	Limestone

Approved Creeping Red Fescue Cultivars:

Aberdeen	Boreal	Epic	Cindy Lou
----------	--------	------	-----------

Fertilizer shall be 10-20-20 analysis. A different analysis of fertilizer may be used provided the 1-2-2 ratio is maintained and the rate of application adjusted to provide the same amount of plant food as a 10-20-20 analysis and as directed.

Native Grass Seeding and Mulching shall be performed in accordance with Section 1660 of the *Standard Specifications* and vegetative cover sufficient to restrain erosion shall be installed immediately following grade establishment.

Measurement and Payment

Native Grass *Seeding and Mulching* will be measured and paid for in accordance with Article 1660-8 of the *Standard Specifications*.

All areas seeded and mulched shall be tacked with asphalt. Crimping of straw in lieu of asphalt tack shall not be allowed on this project.

CRIMPING STRAW MULCH:

Crimping shall be required on this project adjacent to any section of roadway where traffic is to be maintained or allowed during construction. In areas within six feet of the edge of pavement, straw is to be applied and then crimped. After the crimping operation is complete, an additional application of straw shall be applied and immediately tacked with a sufficient amount of undiluted emulsified asphalt.

Straw mulch shall be of sufficient length and quality to withstand the crimping operation.

Crimping equipment including power source shall be subject to the approval of the Engineer providing that maximum spacing of crimper blades shall not exceed 8".

TEMPORARY SEEDING:

Fertilizer shall be the same analysis as specified for *Seeding and Mulching* and applied at the rate of 400 pounds and seeded at the rate of 50 pounds per acre. Sweet Sudan Grass, German Millet or Browntop Millet shall be used in summer months and Rye Grain during the remainder of the year. The Engineer will determine the exact dates for using each kind of seed.

FERTILIZER TOPDRESSING:

Fertilizer used for topdressing on all roadway areas except slopes 2:1 and steeper shall be 10-20-20 grade and shall be applied at the rate of 500 pounds per acre. A different analysis of fertilizer may be used provided the 1-2-2 ratio is maintained and the rate of application adjusted to provide the same amount of plant food as 10-20-20 analysis and as directed.

Fertilizer used for topdressing on slopes 2:1 and steeper and waste and borrow areas shall be 16-8-8 grade and shall be applied at the rate of 500 pounds per acre. A different analysis of fertilizer may be used provided the 2-1-1 ratio is maintained and the rate of application adjusted to provide the same amount of plant food as 16-8-8 analysis and as directed.

SUPPLEMENTAL SEEDING:

The kinds of seed and proportions shall be the same as specified for *Seeding and Mulching*, with the exception that no centipede seed will be used in the seed mix for supplemental seeding. The rate of application for supplemental seeding may vary from 25# to 75# per acre. The actual rate per acre will be determined prior to the time of topdressing and the Contractor will be notified in writing of the rate per acre, total quantity needed, and areas on which to apply the supplemental seed. Minimum tillage equipment, consisting of a sod seeder shall be used for incorporating seed into the soil as to prevent disturbance of existing vegetation. A clodbuster (ball and chain) may be used where degree of slope prevents the use of a sod seeder.

MOWING:

The minimum mowing height on this project shall be 4 inches.

LAWN TYPE APPEARANCE:

All areas adjacent to lawns must be hand finished as directed to give a lawn type appearance. Remove all trash, debris, and stones $\frac{3}{4}$ " and larger in diameter or other obstructions that could interfere with providing a smooth lawn type appearance. These areas shall be reseeded to match their original vegetative conditions, unless directed otherwise by the Field Operations Engineer.

REFORESTATION:

Description

Reforestation will be planted within interchanges and along the outside borders of the road, and in other areas as directed. *Reforestation* is not shown on the plan sheets. See the Reforestation Detail Sheet.

All non-maintained riparian buffers impacted by the placement of temporary fill or clearing activities shall be restored to the preconstruction contours and revegetated with native woody species.

The entire *Reforestation* operation shall comply with the requirements of Section 1670 of the *Standard Specifications*.

Materials

Reforestation shall be bare root seedlings 12"-18" tall.

Construction Methods

Reforestation shall be shall be planted as soon as practical following permanent *Seeding and Mulching*. The seedlings shall be planted in a 16-foot wide swath adjacent to mowing pattern line, or as directed.

Root dip: The roots of reforestation seedlings shall be coated with a slurry of water, and either a fine clay (kaolin) or a superabsorbent that is designated as a bare root dip. The type, mixture ratio, method of application, and the time of application shall be submitted to the Engineer for approval.

With the approval of the Engineer, seedlings may be coated before delivery to the job or at the time of planting, but at no time shall the roots of the seedlings be allowed to dry out. The roots shall be moistened immediately prior to planting.

Seasonal Limitations: *Reforestation* shall be planted from November 15 through March 15.

Measurement and Payment

Reforestation will be measured and paid for in accordance with Article 1670-17 of the *Standard Specifications*.

ENVIRONMENTALLY SENSITIVE AREAS:

Description

This project is located in an *Environmentally Sensitive Area*. This designation requires special procedures to be used for clearing and grubbing, temporary stream crossings, and grading operations within the Environmentally Sensitive Areas identified on the plans and as designated by the Engineer. This also requires special procedures to be used for seeding and mulching and staged seeding within the project.

The Environmentally Sensitive Area shall be defined as a 50-foot buffer zone on both sides of the stream or depression measured from top of streambank or center of depression.

Construction Methods

(A) Clearing and Grubbing

In areas identified as Environmentally Sensitive Areas, the Contractor may perform clearing operations, but not grubbing operations until immediately prior to beginning grading operations as described in Article 200-1 of the *Standard Specifications*. Only clearing operations (not grubbing) shall be allowed in this buffer zone until immediately prior to beginning grading operations. Erosion control devices shall be installed immediately following the clearing operation.

(B) Grading

Once grading operations begin in identified Environmentally Sensitive Areas, work shall progress in a continuous manner until complete. All construction within these areas shall progress in a continuous manner such that each phase is complete and areas are permanently stabilized prior to beginning of next phase. Failure on the part of the Contractor to complete any phase of construction in a continuous manner in Environmentally Sensitive Areas will be just cause for the Engineer to direct the suspension of work in accordance with Article 108-7 of the *Standard Specifications*.

(C) Temporary Stream Crossings

Any crossing of streams within the limits of this project shall be accomplished in accordance with the requirements of Subarticle 107-12 of the *Standard Specifications*.

(D) Seeding and Mulching

Seeding and mulching shall be performed in accordance with Section 1660 of the *Standard Specifications* and vegetative cover sufficient to restrain erosion shall be installed immediately following grade establishment.

Seeding and mulching shall be performed on the areas disturbed by construction immediately following final grade establishment. No appreciable time shall lapse into the contract time without stabilization of slopes, ditches and other areas within the Environmentally Sensitive Areas.

(E) Stage Seeding

The work covered by this section shall consist of the establishment of a vegetative cover on cut and fill slopes as grading progresses. Seeding and mulching shall be done in stages on cut and fill slopes that are greater than 20 feet in height measured along the slope, or greater than 2 acres in area. Each stage shall not exceed the limits stated above.

Additional payments will not be made for the requirements of this section, as the cost for this work shall be included in the contract unit prices for the work involved.

MINIMIZE REMOVAL OF VEGETATION:

The Contractor shall minimize removal of vegetation within project limits to the maximum extent practicable. Vegetation along stream banks and adjacent to other jurisdictional resources outside the construction limits shall only be removed upon approval of Engineer. No additional payment will be made for this minimization work.

CONSTRUCTION MATERIALS MANAGEMENT

(3-19-19) (rev. 04-27-20)

Description

The requirements set forth shall be adhered to in order to meet the applicable materials handling requirements of the NCG010000 permit. Structural controls installed to manage construction materials stored or used on site shall be shown on the E&SC Plan. Requirements for handling materials on construction sites shall be as follows:

Polyacrylamides (PAMS) and Flocculants

Polyacrylamides (PAMS) and flocculants shall be stored in leak-proof containers that are kept under storm-resistant cover or surrounded by secondary containment structures designed to protect adjacent surface waters. PAMS or other flocculants used shall be selected from the NC DWR List of Approved PAMS/Flocculants. The concentration of PAMS and other flocculants used shall not exceed those specified in the NC DWR List of Approved PAMS/Flocculants and in accordance with the manufacturer's instructions. The NC DWR List of Approved PAMS/Flocculants is available at:

https://files.nc.gov/ncdeq/Water+Quality/Environmental+Sciences/ATU/PAM8_30_18.pdf

Equipment Fluids

Fuels, lubricants, coolants, and hydraulic fluids, and other petroleum products shall be handled and disposed of in a manner so as not to enter surface or ground waters and in accordance with applicable state and federal regulations. Equipment used on the site must be operated and maintained properly to prevent discharge of fluids. Equipment, vehicle, and other wash waters shall not be discharged into E&SC basins or other E&SC devices. Alternative controls should be provided such that there is no discharge of soaps, solvents, or detergents.

Waste Materials

Construction materials and land clearing waste shall be disposed of in accordance with North Carolina General Statutes, Chapter 130A, Article 9 - Solid Waste Management, and rules governing the disposal of solid waste (15A NCAC 13B). Areas dedicated for managing construction material and land clearing waste shall be at least 50 feet away from storm drain inlets and surface waters unless it can be shown that no other alternatives are reasonably available. Paint and other liquid construction material waste shall not be dumped into storm drains. Paint and other liquid construction waste washouts should be located at least 50 feet away from storm drain inlets unless there is no alternative. Other options are to install lined washouts or use portable, removable bags or bins. Hazardous or toxic waste shall be managed in accordance with the federal Resource Conservation and Recovery Act (RCRA) and NC Hazardous Waste Rules at 15A NCAC, Subchapter 13A. Litter and sanitary waste shall be managed in a manner to prevent it from entering jurisdictional waters and shall be disposed of offsite.

Herbicide, Pesticide, and Rodenticides

Herbicide, pesticide, and rodenticides shall be stored and applied in accordance with the Federal Insecticide, Fungicide, and Rodenticide Act, North Carolina Pesticide Law of 1971 and labeling restrictions.

Concrete Materials

Concrete materials onsite, including excess concrete, must be controlled and managed to avoid contact with surface waters, wetlands or buffers. No concrete or cement slurry shall be discharged from the site. (Note that discharges from onsite concrete plants require coverage under a separate NPDES permit – NCG140000.) Concrete wash water shall be managed in accordance with the *Concrete Washout Structure* provision. Concrete slurry shall be managed and disposed of in accordance with *NCDOT DGS and HOS DCAR Distribution of Class A Residuals Statewide* (Permit No. WQ0035749). Any hardened concrete residue will be disposed of, or recycled on site, in accordance with state solid waste regulations.

Earthen Material Stock Piles

Earthen material stock piles shall be located at least 50 feet away from storm drain inlets and surface waters unless it can be shown that no other alternatives are reasonably available.

Measurement and Payment

Conditions set within the *Construction Materials Management* provision are incidental to the project for which no direct compensation will be made.

WASTE AND BORROW SOURCES:

(2-16-11) (Rev. 3-17-22)

Payment for temporary erosion control measures, except those made necessary by the Contractor's own negligence or for his own convenience, will be paid for at the appropriate contract unit price for the devices or measures utilized in borrow sources and waste areas.

No additional payment will be made for erosion control devices or permanent seeding and mulching in any commercial borrow or waste pit. All erosion and sediment control practices that may be required on a commercial borrow or waste site will be done at the Contractor's expense.

All offsite Staging Areas, Borrow and Waste sites shall be in accordance with "Borrow and Waste Site Reclamation Procedures for Contracted Projects" located at:

<https://connect.ncdot.gov/resources/roadside/FieldOperationsDocuments/Contract%20Reclamation%20Procedures.pdf>

All forms and documents referenced in the "Borrow and Waste Site Reclamation Procedures for Contracted Projects" shall be included with the reclamation plans for offsite staging areas, and borrow and waste sites.

TEMPORARY DIVERSION:

This work consists of installation, maintenance, and cleanout of *Temporary Diversions* in accordance with Section 1630 of the *Standard Specifications*. The quantity of excavation for installation and cleanout will be measured and paid for as *Silt Excavation* in accordance with Article 1630-3 of the *Standard Specifications*.

SAFETY FENCE AND JURISDICTIONAL FLAGGING:**Description**

Safety Fence shall consist of furnishing materials, installing and maintaining polyethylene or polypropylene fence along the outside riparian buffer, wetland, or water boundary, or other boundaries located within the construction corridor to mark the areas that have been approved to infringe within the buffer, wetland, endangered vegetation, culturally sensitive areas or water. The fence shall be installed prior to any land disturbing activities.

Interior boundaries for jurisdictional areas noted above shall be delineated by stakes and highly visible flagging.

Jurisdictional boundaries at staging areas, waste sites, or borrow pits, whether considered outside or interior boundaries shall be delineated by stakes and highly visible flagging.

Materials**(A) Safety Fencing**

Polyethylene or polypropylene fence shall be a highly visible preconstructed safety fence approved by the Engineer. The fence material shall have an ultraviolet coating.

Either wood posts or steel posts may be used. Wood posts shall be hardwood with a wedge or pencil tip at one end, and shall be at least 5 ft. in length with a minimum nominal 2" x 2" cross section. Steel posts shall be at least 5 ft. in length, and have a minimum weight of 0.85 lb/ft of length.

(B) Boundary Flagging

Wooden stakes shall be 4 feet in length with a minimum nominal 3/4" x 1-3/4" cross section. The flagging shall be at least 1" in width. The flagging material shall be vinyl and shall be orange in color and highly visible.

Construction Methods

No additional clearing and grubbing is anticipated for the installation of this fence. The fence shall be erected to conform to the general contour of the ground.

(A) Safety Fencing

Posts shall be set at a maximum spacing of 10 ft., maintained in a vertical position and hand set or set with a post driver. Posts shall be installed a minimum of 2 ft. into the ground. If hand set, all backfill material shall be thoroughly tamped. Wood posts may be sharpened to a dull point if power driven. Posts damaged by power driving shall be removed and replaced prior to final acceptance. The tops of all wood posts shall be cut at a 30-degree angle. The wood posts may, at the option of the Contractor, be cut at this angle either before or after the posts are erected.

The fence geotextile shall be attached to the wood posts with one 2" galvanized wire staple across each cable or to the steel posts with wire or other acceptable means.

Place construction stakes to establish the location of the safety fence in accordance with Article 105-9 or Article 801-1 of the *Standard Specifications*. No direct pay will be made for the staking of the safety fence. All stakeouts for safety fence shall be considered incidental to the work being paid for as "Construction Surveying", except that where there is no pay item for construction surveying, all safety fence stakeout will be performed by state forces.

The Contractor shall be required to maintain the safety fence in a satisfactory condition for the duration of the project as determined by the Engineer.

(B) Boundary Flagging

Boundary flagging delineation of interior boundaries shall consist of wooden stakes on 25 feet maximum intervals with highly visible orange flagging attached. Stakes shall be installed a minimum of 6" into the ground. Interior boundaries may be staked on a tangent that runs parallel to buffer but must not encroach on the buffer at any location. Interior boundaries of hand clearing shall be identified with a different colored flagging to distinguish it from mechanized clearing.

Boundary flagging delineation of interior boundaries will be placed in accordance with Article 105-9 or Article 801-1 of the *Standard Specifications*. No direct pay will be made for delineation of the interior boundaries. This delineation will be considered incidental to the work being paid for as *Construction Surveying*, except that where there is no pay item or construction surveying the cost of boundary flagging delineation shall be included in the unit prices bid for the various items in the contract. Installation for delineation of all jurisdictional boundaries at staging areas, waste sites, or borrow pits shall consist of wooden stakes on 25 feet maximum intervals with highly visible orange flagging attached. Stakes shall be installed a minimum of 6" into the ground. Additional flagging may be placed on overhanging vegetation to enhance visibility but does not substitute for installation of stakes.

Installation of boundary flagging for delineation of all jurisdictional boundaries at staging areas, waste sites, or borrow pits shall be performed in accordance with Subarticle 230-4(B)(5) or Subarticle 802-2(F) of the *Standard Specifications*. No direct pay will be made for this delineation, as the cost of same shall be included in the unit prices bid for the various items in the contract.

The Contractor shall be required to maintain alternative stakes and highly visible flagging in a satisfactory condition for the duration of the project as determined by the Engineer.

Measurement and Payment

Safety Fence will be measured and paid as the actual number of linear feet of polyethylene or polypropylene fence installed in place and accepted. Such payment will be full compensation including but not limited to furnishing and installing fence geotextile with necessary posts and post bracing, staples, tie wires, tools, equipment and incidentals necessary to complete this work.

Payment will be made under:

Pay Item	Pay Unit
Safety Fence	Linear Foot

BORROW PIT DEWATERING BASIN:

(3-17-09) (Rev 3-2-11)

Description

Water discharge from borrow pit sites shall not cause surface waters to exceed 50 NTUs (nephelometric turbidity unit) in streams not designated as trout waters and 10 NTUs in streams, lakes or reservoirs designated as trout waters. For lakes and reservoirs not designated as trout waters, the turbidity shall not exceed 25 NTUs. If the turbidity exceeds these levels due to natural background conditions, the existing turbidity level shall not be increased.

Construct, maintain and remove earth embankments used to reduce turbidity from dewatering borrow sites. Work includes providing porous coir fiber baffle, filtration geotextile, stone and outlet structures; cleaning out, maintaining, removing and disposing of the borrow pit dewatering basin and all components; and reshaping, dressing, seeding and mulching the area.

Materials

Refer to Division 10

Item	Section
Riprap, Class A, B, 1, and 2	1042
Geotextile for Drainage, Type 2	1056
Coir Fiber Baffle	1640-2

Use suitable excavated materials, as specified in Sections 225, 230 and 240 of the *Standard Specifications* in the construction of earth embankments for borrow pit dewatering basins, except where otherwise specified.

Construction Methods

Construct borrow pit dewatering basins according to the detail in the erosion control plans, and at locations shown on Reclamation Plans or in areas as directed.

The volume of the borrow pit dewatering basin will be based on a 2 hour retention time. The pump rate shall not exceed 1,000 GPM. The Contractor, at his option, may use a greater retention time for managing turbidity.

The straight line distance between the inlet and outlet shall be divided to include a forebay chamber in the upper quarter cell. Install one porous coir fiber baffle across the full width of the basin to delineate the forebay chamber. Do not use earthen or rock baffle. Install filtration geotextile on the interior side slopes and the floor of the forebay.

The water pumped from the borrow pit into the dewatering basin shall be obtained from the top of the water column and shall be discharged into the forebay in a non-erodible manner.

The borrow pit dewatering basin outlet shall be a vertical non-perforated riser pipe or flash board riser attached with a watertight connection to a barrel that carries the water through the embankment.

Maintenance and Removal

Maintain the borrow pit dewatering basin, coir fiber baffle, and remove and dispose of silt accumulations in accordance with Article 1630-3 of the *Standard Specifications*. The Contractor may include a drain device for maintenance and removal at his discretion.

Remove the borrow pit dewatering basin once dewatering operations are completed. Grade, seed, and mulch the area after removal of the borrow pit dewatering basin in accordance with Section 1660 of the *Standard Specifications*. The area shall be stabilized with an approved groundcover before final acceptance of the site.

Measurement and Payment

No direct payment will be made for borrow pit dewatering basins with the exception of the work of silt removal during dewatering basin operation and the work of seeding and mulching after removal of the dewatering basin. All other work and materials required for installation, maintenance and removal of borrow pit dewatering basins shall be incidental to *Borrow Excavation*. Such price and payments will be full compensation for the work of constructing, maintaining and removing the borrow pit dewatering basin including, but not limited to, the construction and removal of the borrow pit dewatering basin; furnishing of the outlet structure, baffle, filtration geotextile, stone and optional drain devices; and removal of all such items once dewatering operations are completed.

Removal and disposal of silt accumulations during dewatering operations will be measured and paid at the contract unit price per cubic yard for *Silt Excavation* in accordance with Article 1630-4 of the *Standard Specifications*.

Grading, seeding, and mulching the area after removal of the borrow pit dewatering basin will be measured and paid at the contract unit price per acre for *Seeding and Mulching* in accordance with Section 1660-8 of the *Standard Specifications*.

CULVERT DIVERSION CHANNEL:

Description

This work consists of providing a *Culvert Diversion Channel* to detour the existing stream around the culvert construction site at locations shown on the plans. Work includes constructing the diversion channel, disposing of excess materials, providing and placing geotextile liner, maintaining the diversion area in an acceptable condition, removing geotextile liner, backfilling diversion channel area with suitable material, and providing proper drainage when diversion channel area is abandoned.

Materials

Refer to Division 10

Item	Section
Geotextile for Soil Stabilization, Type 4	1056

Construction Methods

Grade channel according to the plans with channel surface free of obstructions, debris, and pockets of low-density material. Utilize suitable material and provide disposal area for unsuitable material.

Line channel with geotextile unrolled in the direction of flow and lay smoothly but loosely on soil surface without creases. Bury top of slope geotextile edge in a trench at least 5" deep and tamp securely. Make vertical overlaps a minimum of 18" with upstream geotextile overlapping the downstream geotextile.

Secure geotextile with eleven gauge wire staples shaped into a *u* shape with a length of not less than 6" and a throat not less than 1" in width. Place staples along outer edges and throughout the geotextile a maximum of 3 ft. horizontally and vertically.

Measurement and Payment

Culvert Diversion Channel will be measured and paid for as the actual number of cubic yards excavated, as calculated from the typical section throughout the length of the diversion channel as shown on the final approved plans.

Geotextile for Soil Stabilization will be measured and paid for in accordance with Article 270-4 of the *Standard Specifications*.

Such price and payment shall be considered full compensation for all work covered by this section including all materials, construction, maintenance, and removal of *Culvert Diversion Channel*.

Payment will be made under:

Pay Item	Pay Unit
Culvert Diversion Channel	Cubic Yard

IMPERVIOUS DIKE:

(9-9-11)(Rev. 11-15-22)

Description

This work consists of furnishing, installing, maintaining, pumping and removing an *Impervious Dike* for the purpose of diverting normal stream flow around the construction site. The Contractor shall construct an impervious dike in such a manner approved by the Engineer. The impervious dike shall not permit seepage of water into the construction site or contribute to siltation of the stream. The impervious dike shall be constructed of an acceptable material in the locations noted on the plans or as directed by the Engineer.

Materials

Acceptable materials shall include but not be limited to sheet piles, sandbags, and/or the placement of an acceptable size stone lined with polypropylene or other impervious geotextile.

Earth material shall not be used to construct an impervious dike when it is in direct contact with the stream unless vegetation can be established before contact with the stream takes place.

Construction Methods

Where impervious dikes are shown on the plans and used to dewater or lower the water elevation, construct in accordance with Article 410-4 and 410-5.

Measurement and Payment

Impervious Dike will be measured and paid as the actual number of linear feet of impervious dike(s) constructed, measured in place from end to end of each separate installation that has been completed and accepted by the Engineer. Such price and payment will be full compensation for all work including but not limited to furnishing materials, construction, maintenance, pumping and removal of the impervious dike.

Payment will be made under:

Pay Item	Pay Unit
Impervious Dike	Linear Foot

10/30/2025

PUMP AROUND OPERATION:**Description**

The work covered by this section consists of furnishing, installing, maintaining and removing any and all pump around systems used on this project. The Contractor shall install a pump around system in locations as shown in the plans and in other locations approved by the Engineer. The pump around system shall provide a passageway for the stream flow around the work site. See the Example of Pump Around Operation Detail Sheet in the Erosion Control plans.

The quantity of pump around systems may be increased, decreased, or eliminated entirely as directed. Such variations in quantity will not be considered as alterations in the details of construction or a change in the character of the work.

Materials

Item	Section
Special Stilling Basin	1639

Impervious Dike shall meet the specifications as provided elsewhere in this contract.

Pumps shall be of sufficient size to divert the stream flow around the work area, as approved by the Engineer.

Construction Methods

Install *impervious dike(s)* as shown on the plans or as directed. Pump water around the work site. If the water is turbid or exposed to bare soil, pump through a *special stilling basin*. Once the work is complete in an area remove the *impervious dike(s)* and pump system, and stabilize the area.

Measurement and Payment

Impervious Dike will be measured and paid for as provided elsewhere in this contract.

Special Stilling Basin will be measured and paid for in accordance with Article 1639-4 of the *Standard Specifications*.

Payment for pumping operations shall be considered incidental to the work of installing pipes, culverts and channels. The pumping operations shall include but not be limited to, diverting the stream flow around the work area and pumping runoff from the work area into a stilling basin, special stilling basin or other sediment control device. No additional payment will be made for

furnishing materials or maintenance of the pumping operations for the installation of pipes, culverts and channels.

The above prices and payments will be full compensation for all work covered by this section including, but not limited to furnishing all of the necessary materials, construction, maintenance and removal of the impervious dike and pump around system.

CONCRETE WASHOUT:

(10-22-15)(Rev. 4-15-25)

Description

Concrete washouts are impermeable enclosures, above or below grade, to contain concrete wastewater and associated concrete mix from cleaning of ready-mix trucks, drums, pumps, tools or other equipment. Concrete washouts must collect and retain all the concrete washout water and solids, so that this material does not migrate to surface waters or into the ground water. These enclosures are not intended for concrete waste not associated with washout operations.

Acceptable concrete washouts may include constructed earthen structures, above or below ground, or commercially available devices designed specifically to capture concrete wash water.

Materials

Refer to Division 10 of the *Standard Specifications*.

Item	Section
Temporary Silt Fence	1605

Safety Fence shall meet the specifications as provided elsewhere in this contract.

Geomembrane basin liner shall consist of a minimum 10 mil thick polypropylene or polyethylene geomembrane.

Construction Methods

Build an enclosed earthen berm or excavate to form an enclosure in accordance with the details and as directed by the Engineer near the project entrance(s) or at location(s) of concrete operations. Structures shall be constructed a minimum of 50 feet from drainage conveyances or jurisdictional streams or wetlands. Alternate structure designs or plans for management of concrete washout may be submitted for review and approval by the Engineer. Include in the alternate plan the method used to retain, treat and dispose of the concrete washout wastewater generated within the project limits and in accordance with the minimum setback requirements.

Install temporary silt fence around the perimeter of the structure enclosure in accordance with the details and as directed by the Engineer if the structure is not located in an area where existing erosion and sedimentation control devices are capable of containing stormwater runoff.

Post a sign with the words “Concrete Washout” in close proximity of the concrete washout area, so it is clearly visible to site personnel. Install safety fence as directed by the Engineer for visibility to construction traffic.

Install prefabricated concrete washouts, designed specifically to capture concrete wash water, at locations of additional concrete pouring operations. Acceptable systems may include geotextile lined containers, vinyl or plastic containers or roll-off containers, with or without filter bags with a minimum functional holding capacity of 36 cubic feet (1.33 cubic yards). Submit prefabricated concrete washout system for approval by the Engineer prior to installation. Place prefabricated concrete washout devices to a minimum 50 foot setback from drainage conveyances and jurisdictional streams and wetlands. If the minimum setback cannot be achieved, provide secondary containment to prevent accidental release of wastewater from reaching drainage conveyances or streams.

Prefabricated concrete washouts must be clearly and visibly labeled as such, either by the manufacturer on the product itself, or by a sign with the words “Concrete Washout” in close proximity of the concrete washout area so it is clearly visible to site personnel.

Maintenance and Removal

Maintain the concrete washout structure(s) to provide adequate holding capacity plus a minimum freeboard of 12 inches. Remove and dispose of hardened concrete and return the structure to a functional condition after reaching 75% capacity. Inspect concrete washout structures for damage to liner or structure to maintain functionality.

Maintain prefabricated concrete washout systems per manufacturer’s recommendations. Inspect concrete washout structures for damage to linings or structure and repair or replace as necessary.

Remove the concrete washout structures and sign upon project completion. Grade the area to match the existing topography and permanently seed and mulch area. Dispose of prefabricated concrete washout structures according to state or local waste regulations.

Measurement and Payment

Concrete Washout Structure will be measured and paid per each enclosure installed in accordance with the details in the plans. If alternate plans or details are approved, those structures will also be paid for per each approved and installed structure. Such price and payment will be full compensation for all work including, but not limited to, furnishing all materials, labor, equipment, signage, slurry solidification and incidentals necessary to construct, maintain and remove *Concrete Washout Structure* and dispose of residual concrete washout wastewater and concrete solids.

Prefabricated Concrete Washout will be measured and paid per each system installed in accordance with the manufacturer’s recommendations. Such price and payment will be full compensation for all work including, but not limited to, furnishing all materials, labor, equipment, signage, slurry solidification and incidentals necessary to install, maintain and remove

Prefabricated Concrete Washout, and dispose of residual concrete washout wastewater and concrete solids.

Temporary Silt Fence will be measured and paid for in accordance with Article 1605-5 of the *Standard Specifications*.

Safety Fence shall be measured and paid for as provided elsewhere in this contract.

No measurement will be made for over excavation or stockpiling or other items necessary to complete this work.

Payment will be made under:

Pay Item	Pay Unit
Concrete Washout Structure	Each
Prefabricated Concrete Washout	Each

LITTER REMOVAL (MOWING AREAS ONLY):

(07-19-22) (Rev 8-25-25)

Description

This work consists of the pickup, removal, and disposal of litter from roadsides within the construction project prior to mowing operations.

Construction Methods

Provide labor, equipment and materials necessary for the pickup and removal of litter from non-construction sources and the disposal of same into state approved landfills. The Contractor shall abide by all ordinances, laws and regulations regarding disposal of litter and recycling of eligible materials. Wastes generated from construction activities shall be managed as provided elsewhere in the contract. Litter items may consist of any item not considered normal to the right-of-way, including but not limited to, varied sizes of bottles, cans, paper, tires, tire pieces, lumber, vehicle parts, building supplies, metals, household furnishings, cardboard, plastics, ladders, brush and other items not considered normal to the right of way. Litter removal shall be performed in designated areas within five days prior to any mowing operations and as directed. Designated areas shall include vegetated medians and shoulders within the project limits including all interchange ramps and other areas to be mown. Designated areas may be omitted for litter removal by the Engineer due to safety concerns.

The Contractor shall provide adequate personnel and materials to collect and remove litter. The Contractor shall be responsible for locating and utilizing approved local landfills and recycling facilities. Refer to Section 107-25 of the *Standard Specifications* for potential hazardous materials. All collected litter shall be containerized immediately and kept off the traveled portions of the roadway, shoulders, and rights-of-way (including paved shoulders). All collected litter that is

small enough to be placed in a bag shall be bagged immediately. All collected litter that is too large for a bag shall be placed into a vehicle. Extended storage or stockpiling of collected litter and recyclables will not be permitted.

The Contractor's personnel shall dispose of any litter in a landfill approved by North Carolina Division of Waste Management. The Contractor will not be allowed to use NCDOT accounts at the landfills/recycling centers nor be allowed to dispose of the litter in NCDOT trash containers on any NCDOT property.

The Contractor shall report online the number of bags of litter and any recycling on the NCDOT Litter Management Website on the date of the pickup at the following website:

<https://apps.ncdot.gov/LM>

An access code ('Pickup Key') for the online reporting portal may be obtained via emailing the Roadside Environmental Unit Litter Management Section at ncdot.clr@ncdot.gov. The Contractor shall request access to the litter removal reporting website prior to starting initial litter collection operations.

Measurement and Payment

The quantity of litter removal to be performed will be affected by the actual conditions that occur during construction of the project. The quantity of litter removal may be increased, decreased, or eliminated entirely as directed. Such variations in quantity will not be considered as alterations in the details of construction or a change in the character of the work.

Manual Litter Removal will be measured and paid as the actual number of man hours each worker spends picking up litter. Such price and payment will be full compensation for all litter removal work covered by *Litter Removal*, including, but not limited to, furnishing all materials, labor, equipment, transport, reporting, and incidentals necessary to accomplish the work.

Litter Disposal will be measured and paid for by the actual number of tons of litter collected and properly disposed of at a state approved landfill. Such price and payment will be full compensation for all fees, labor, transport, and incidentals necessary to dispose of collected litter associated with *Litter Removal*.

All traffic control necessary to provide a safe work area for *Litter Removal* shall be paid for as specified elsewhere in the contract.

Payment will be made under:

Pay Item	Pay Unit
Manual Litter Removal	MHR
Litter Disposal	TON

10/30/2025

U-3609B

TS-1

Wayne County

Signals and Intelligent Transportation Systems
Project Special Provisions
(Version 24.1)

Prepared By: JPG
18-Aug-25

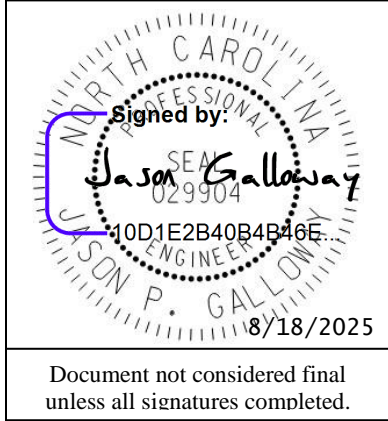

Contents

1. 2024 STANDARD SPECIFICATIONS FOR ROADS & STRUCTURES.....3

1.1. ELECTRICAL JUNCTION BOXES (1091-5).....3

1.2. TRAFFIC SIGNAL ACTIVATION (1700-4).....3

2. SIGNAL HEADS.....3

2.1. MATERIALS.....3

A. General:.....3

B. Vehicle Signal Heads:.....5

C. Pedestrian Signal Heads:.....7

3. CONTROLLERS WITH CABINETS9

3.1. MATERIALS – TYPE 2070LX CONTROLLERS9

3.2. MATERIALS – GENERAL CABINETS.....9

3.3. MATERIALS – TYPE 170E CABINETS10

A. Type 170 E Cabinets General:.....10

B. Type 170 E Cabinet Electrical Requirements:.....11

C. Type 170 E Cabinet Physical Requirements:.....17

D. Model 2018 Enhanced Conflict Monitor:.....20

E. Preemption and Sign Control Box30

3.4. MATERIALS – TYPE 170 DETECTOR SENSOR UNITS.....33

4. MICROWAVE VEHICLE DETECTION SYSTEM - MULTIPLE DETECTION ZONES.....33

4.1. DESCRIPTION.....33

4.2. MATERIALS.....33

4.3. CONSTRUCTION METHODS.....34

4.4. MEASUREMENT AND PAYMENT.....34

5. METAL POLE SUPPORTS34

5.1. METAL POLES.....34

A. General:.....34

B. Materials:.....36

C. Design:.....38

D. Strain Poles:.....40

5.2. DRILLED PIER FOUNDATIONS FOR METAL POLES.....40

A. Description:.....41

B. Soil Test and Foundation Determination:.....41

C. Drilled Pier Construction:.....44

5.3. METAL POLE REMOVALS.....44

A. Description:.....44

B. Construction Methods:.....44

5.4. POLE NUMBERING SYSTEM.....44

A. New Poles.....44

5.5. MEASUREMENT AND PAYMENT.....44

- 6. ETHERNET EDGE SWITCH.....45**
 - 6.1. DESCRIPTION45
 - A. Ethernet Edge Switch:45
 - B. Network Management:45
 - 6.2. MATERIALS45
 - A. General:45
 - B. Compatibility Acceptance.....46
 - C. Standards:46
 - D. Functional:46
 - E. Physical Features:47
 - F. Management Capabilities:48
 - G. Electrical Specifications:49
 - H. Environmental Specifications:49
 - I. Ethernet Patch Cable:49
 - 6.3. CONSTRUCTION METHODS50
 - A. General:50
 - B. Edge Switch:50
 - 6.4. MEASURMENT AND PAYMENT.....50

U-3609B

TS-3

Wayne County

1. 2024 STANDARD SPECIFICATIONS FOR ROADS & STRUCTURES

The 2024 Standard Specifications are revised as follows:

1.1. ELECTRICAL JUNCTION BOXES (1091-5)

Page 10-209, revise paragraphs beginning on line 26 to read "Provide electrical junction boxes with covers of the type and size indicated by the contract or plans for the termination of conduits. Boxes and covers shall meet all requirements and specifications of ANSI/SCTE 77 2017. Structural load tests shall meet the Tier 15 application type."

Page 10-209, line 28, revise title of section 1091-5(B) from "Polymer Concrete (PC) Junction Boxes" to "Polymer Concrete (PC), Composite, and Thermoplastic Junction Boxes".

Page 10-209, revise paragraphs beginning on line 29 through line 41 to read "For PC junction boxes, use polymer concrete material made of an aggregate consisting of sand and gravel bound together with a polymer and reinforced with glass strands to fabricate box and cover components. Provide junction boxes which have bolted covers and open bottoms. Provide vertical extensions of 6 inches to 12 inches as required by project provisions.

Provide the required logo on the cover. Provide at least two size 3/8 inch diameter hex head stainless steel cover bolts to match inserts in the box. Provide pull slot(s) with stainless steel pin(s). Bodies of junction boxes shall be a single piece.

Polymer concrete, composite, and thermoplastic junction boxes are not required to be listed electrical devices."

1.2. TRAFFIC SIGNAL ACTIVATION (1700-4)

Page 17-4, revise paragraph beginning on line 42 through line 46 to read "Prior to placing signal in the steady (stop-and-go) mode, the signal should be placed in yellow-red flashing mode for up to 7 days or as directed by the Engineer. Yellow-red flashing mode differs from the red-red flashing mode shown in the signal plan. Yellow-red flash mode includes flashing the yellow signal indications on all main street through movements while flashing the red signal indications on all side street signal heads and any left turn heads on the main street. The signal should not be placed in the steady (stop-and-go) mode on a Saturday or Sunday without prior approval from the Engineer. Do not place the signal in steady (stop-and-go) mode until inspected and without prior approval of the Engineer."

2. SIGNAL HEADS

2.1. MATERIALS

A. General:

Fabricate vehicle signal head housings and end caps from die-cast aluminum. Fabricate 12-inch and 16-inch pedestrian signal head housings and end caps from die-cast aluminum. Fabricate 9-inch pedestrian signal head housings, end caps, and visors from virgin polycarbonate material. Provide visor mounting screws, door latches, and hinge pins fabricated from stainless steel. Provide interior screws, fasteners, and metal parts fabricated from stainless steel.

Fabricate tunnel and traditional visors from sheet aluminum.

U-3609B**TS-4****Wayne County**

Paint all surfaces inside and outside of signal housings and doors. Paint outside surfaces of tunnel and traditional visors, wire outlet bodies, wire entrance fitting brackets and end caps when supplied as components of messenger cable mounting assemblies, pole and pedestal mounting assemblies, and pedestrian pushbutton housings. Have electrostatically-applied, fused-polyester paint in highway yellow (Federal Standard 595C, Color Chip Number 13538) a minimum of 2.5 to 3.5 mils thick. Do not apply paint to the latching hardware, rigid vehicle signal head mounting brackets for mast-arm attachments, messenger cable hanger components or balance adjuster components.

Have the interior surfaces of tunnel and traditional visors painted an alkyd urea black synthetic baking enamel with a minimum gloss reflectance and meeting the requirements of MIL-E-10169, "Enamel Heat Resisting, Instrument Black."

Where required, provide polycarbonate signal heads and visors that comply with the provisions pertaining to the aluminum signal heads listed on the QPL with the following exceptions:

Fabricate signal head housings, end caps, and visors from virgin polycarbonate material. Provide UV stabilized polycarbonate plastic with a minimum thickness of 0.1 ± 0.01 inches that is highway yellow (Federal Standard 595C, Color Chip 13538). Ensure the color is incorporated into the plastic material before molding the signal head housings and end caps. Ensure the plastic formulation provides the following physical properties in the assembly (tests may be performed on separately molded specimens):

Test	Required	Method
Specific Gravity	1.17 minimum	ASTM D 792
Flammability	Self-extinguishing	ASTM D 635
Tensile Strength, yield, PSI	8500 minimum	ASTM D 638
Izod impact strength, ft-lb/in [notched, 1/8 inch]	12 minimum	ASTM D 256

For pole mounting, provide side of pole mounting assemblies with framework and all other hardware necessary to make complete, watertight connections of the signal heads to the poles and pedestals. Fabricate the mounting assemblies and frames from aluminum with all necessary hardware, screws, washers, etc. to be stainless steel. Provide mounting fittings that match the positive locking device on the signal head with the serrations integrally cast into the brackets. Provide upper and lower pole plates that have a 1 ¼-inch vertical conduit entrance hubs with the hubs capped on the lower plate and 1 ½-inch horizontal hubs. Ensure that the assemblies provide rigid attachments to poles and pedestals so as to allow no twisting or swaying of the signal heads. Ensure that all raceways are free of sharp edges and protrusions, and can accommodate a minimum of ten Number 14 AWG conductors.

For pedestal mounting, provide a post-top slipfitter mounting assembly that matches the positive locking device on the signal head with serrations integrally cast into the slipfitter. Provide stainless steel hardware, screws, washers, etc. Provide a minimum of six 3/8 X 3/4-inch long square head bolts for attachment to pedestal. Provide a center post for multi-way slipfitters.

For light emitting diode (LED) traffic signal modules, provide the following requirements for inclusion on the Department's Qualified Products List for traffic signal equipment.

1. Sample submittal,

2. Third-party independent laboratory testing results for each submitted module with evidence of testing and conformance with all of the Design Qualification Testing specified in section 6.4 of each of the following Institute of Transportation Engineers (ITE) specifications:
 - Vehicle Traffic Control Signal Heads – Light Emitting Diode (LED) Circular Signal Supplement
 - Vehicle Traffic Control Signal Heads – Light Emitting Diode (LED) Vehicle Arrow Traffic Signal Supplement
 - Pedestrian Traffic Control Signal Indications –Light Emitting Diode (LED) Signal Modules.

(Note: The Department currently recognizes two approved independent testing laboratories. They are Intertek ETL Semko and Light Metrics, Incorporated with Garwood Laboratories. Independent laboratory tests from other laboratories may be considered as part of the QPL submittal at the discretion of the Department,

3. Evidence of conformance with the requirements of these specifications,
4. A manufacturer’s warranty statement in accordance with the required warranty, and
5. Submittal of manufacturer’s design and production documentation for the model, including but not limited to, electrical schematics, electronic component values, proprietary part numbers, bill of materials, and production electrical and photometric test parameters.
6. Evidence of approval of the product to bear the Intertek ETL Verified product label for LED traffic signal modules.

Ensure LED traffic signal modules meet the performance requirements for the minimum period of 15 years, provide a written warranty against defects in materials and workmanship for the modules for a period of 15 years after installation of the modules. During the warranty period, the manufacturer must provide new replacement modules within 45 days of receipt of modules that have failed at no cost to the State. Repaired or refurbished modules may not be used to fulfill the manufacturer’s warranty obligations. Provide manufacturer’s warranty documentation to the Department during evaluation of product for inclusion on Qualified Products List (QPL).

B. Vehicle Signal Heads:

Comply with the ITE standard “Vehicle Traffic Control Signal Heads”. Provide housings with provisions for attaching backplates.

Provide visors that are 8 inches in length for 8-inch vehicle signal head sections. Provide visors that are 10 inches in length for 12-inch vehicle signal heads.

Provide a termination block with one empty terminal for field wiring for each indication plus one empty terminal for the neutral conductor. Have all signal sections wired to the termination block. Provide barriers between the terminals that have terminal screws with a minimum Number 8 thread size and that will accommodate and secure spade lugs sized for a Number 10 terminal screw.

Mount termination blocks in the yellow signal head sections on all in-line vehicle signal heads. Mount the termination block in the red section on five-section vehicle signal heads.

Furnish vehicle signal head interconnecting brackets. Provide one-piece aluminum brackets less than 4.5 inches in height and with no threaded pipe connections. Provide hand holes on the bottom of the brackets to aid in installing wires to the signal heads. Lower brackets that carry no wires and are used only for connecting the bottom signal sections together may be flat in construction.

For messenger cable mounting, provide messenger cable hangers, wire outlet bodies, balance adjusters, bottom caps, wire entrance fitting brackets, and all other hardware necessary to make complete, watertight connections of the vehicle signal heads to the messenger cable. Fabricate messenger cable hanger components, wire outlet bodies and balance adjuster components from stainless steel or malleable iron galvanized in accordance with ASTM A153 (Class A) or ASTM A123. Provide serrated rings made of aluminum. Provide messenger cable hangers with U-bolt clamps. Fabricate washers, screws, hex-head bolts and associated nuts, clevis pins, cotter pins, U-bolt clamps and nuts from stainless steel.

For mast-arm mounting, provide rigid vehicle signal head mounting brackets and all other hardware necessary to make complete, watertight connections of the vehicle signal heads to the mast arms and to provide a means for vertically adjusting the vehicle signal heads to proper alignment. Fabricate the mounting assemblies from aluminum, and provide serrated rings made of aluminum. Provide stainless steel cable attachment assemblies to secure the brackets to the mast arms. Ensure all fastening hardware and fasteners are fabricated from stainless steel.

Provide LED vehicular traffic signal modules (hereafter referred to as modules) that consist of an assembly that uses LEDs as the light source in lieu of an incandescent lamp for use in traffic signal sections. Use LEDs that are aluminum indium gallium phosphorus (AlInGaP) technology for red and yellow indications and indium gallium nitride (InGaN) for green indications. Install the ultra bright type LEDs that are rated for 100,000 hours of continuous operation from -40°F to +165°F. Design modules to have a minimum useful life of 15 years and to meet all parameters of this specification during this period of useful life.

For the modules, provide spade terminals crimped to the lead wires and sized for a #10 screw connection to the existing terminal block in a standard signal head. Do not provide other types of crimped terminals with a spade adapter.

Ensure the power supply is integral to the module assembly. On the back of the module, permanently mark the date of manufacture (month & year) or some other method of identifying date of manufacture.

Tint the red, yellow and green lenses to correspond with the wavelength (chromaticity) of the LED. Transparent tinting films are unacceptable. Provide a lens that is integral to the unit with a smooth outer surface.

1. LED Circular Signal Modules:

Provide modules in the following configurations: 12-inch circular sections, and 8-inch circular sections. All makes and models of LED modules purchased for use on the State Highway System shall appear on the current NCDOT Traffic Signal Qualified Products List (QPL).

Provide the manufacturer’s model number and the product number (assigned by the Department) for each module that appears on the 2024 or most recent Qualified Products List. In addition, provide manufacturer’s certification in accordance with Article 106-3 of the *Standard Specifications*, that each module meets or exceeds the ITE “Vehicle Traffic Control Signal Heads – Light Emitting Diode (LED) Circular Signal Supplement” dated June 27, 2005 (hereafter referred to as VTCSH Circular Supplement) and other requirements stated in this specification.

Provide modules that meet the following requirements when tested under the procedures outlined in the VTCSH Circular Supplement:

Module Type	Max. Wattage at 165° F	Nominal Wattage at 77° F
12-inch red circular	17	11

8-inch red circular	13	8
12-inch green circular	15	15
8-inch green circular	12	12

For yellow circular signal modules, provide modules tested under the procedures outlined in the VTCSH Circular Supplement to insure power required at 77° F is 22 Watts or less for the 12-inch circular module and 13 Watts or less for the 8-inch circular module.

Note: Use a wattmeter having an accuracy of ±1% to measure the nominal wattage and maximum wattage of a circular traffic signal module. Power may also be derived from voltage, current and power factor measurements.

2. LED Arrow Signal Modules

Provide 12-inch omnidirectional arrow signal modules. All makes and models of LED modules purchased for use on the State Highway System shall appear on the current NCDOT Traffic Signal Qualified Products List (QPL).

Provide the manufacturer’s model number and the product number (assigned by the Department) for each module that appears on the 2024 or most recent Qualified Products List. In addition, provide manufacturer’s certification in accordance with Article 106-3 of the *Standard Specifications*, that each module meets or exceeds the requirements for 12-inch omnidirectional modules specified in the ITE “Vehicle Traffic Control Signal Heads – Light Emitting Diode (LED) Vehicle Arrow Traffic Signal Supplement” dated July 1, 2007 (hereafter referred to as VTCSH Arrow Supplement) and other requirements stated in this specification.

Provide modules that meet the following requirements when tested under the procedures outlined in the VTCSH Arrow Supplement:

Module Type	Max. Wattage at 165° F	Nominal Wattage at 77° F
12-inch red arrow	12	9
12-inch green arrow	11	11

For yellow arrow signal modules, provide modules tested under the procedures outlined in the VTCSH Arrow Supplement to insure power required at 77° F is 12 Watts or less.

Note: Use a wattmeter having an accuracy of ±1% to measure the nominal wattage and maximum wattage of an arrow traffic signal module. Power may also be derived from voltage, current and power factor measurements.

C. Pedestrian Signal Heads:

Provide pedestrian signal heads with international symbols that meet the MUTCD. Do not provide letter indications.

Comply with the ITE standard for “Pedestrian Traffic Control Signal Indications” and the following sections of the ITE standard for “Vehicle Traffic Control Signal Heads” in effect on the date of advertisement:

- Section 3.00 - “Physical and Mechanical Requirements”
- Section 4.01 - “Housing, Door, and Visor: General”
- Section 4.04 - “Housing, Door, and Visor: Materials and Fabrication”
- Section 7.00 - “Exterior Finish”

Provide a double-row termination block with three empty terminals and number 10 screws for field wiring. Provide barriers between the terminals that accommodate a spade lug sized for number

10 terminal screws. Mount the termination block in the hand section. Wire all signal sections to the terminal block.

Where required by the plans, provide 16-inch pedestrian signal heads with traditional three-sided, rectangular visors, 6 inches long. Where required by the plans, provide 12-inch pedestrian signal heads with traditional three-sided, rectangular visors, 8 inches long.

Provide 2-inch diameter pedestrian push-buttons with weather-tight housings fabricated from die-cast aluminum and threading in compliance with the NEC for rigid metal conduit. Provide a weep hole in the housing bottom and ensure that the unit is vandal resistant.

Provide push-button housings that are suitable for mounting on flat or curved surfaces and that will accept 1/2-inch conduit installed in the top. Provide units that have a heavy duty push-button assembly with a sturdy, momentary, normally-open switch. Have contacts that are electrically insulated from the housing and push-button. Ensure that the push-buttons are rated for a minimum of 5 mA at 24 volts DC and 250 mA at 12 volts AC.

Provide standard R10-3 signs with mounting hardware that comply with the MUTCD in effect on the date of advertisement. Provide R10-3E signs for countdown pedestrian heads and R10-3B for non-countdown pedestrian heads.

Design the LED pedestrian traffic signal modules (hereafter referred to as modules) for installation into standard pedestrian traffic signal sections that do not contain the incandescent signal section reflector, lens, eggcrate visor, gasket, or socket. Provide modules that consist of an assembly that uses LEDs as the light source in lieu of an incandescent lamp. Use LEDs that are of the latest aluminum indium gallium phosphorus (AlInGaP) technology for the Portland Orange hand and countdown displays. Use LEDs that are of the latest indium gallium nitride (InGaN) technology for the Lunar White walking man displays. Install the ultra-bright type LEDs that are rated for 100,000 hours of continuous operation from -40°F to +165°F. Design modules to have a minimum useful life of 60 months and to meet all parameters of this specification during this period of useful life.

Design all modules to operate using a standard 3 - wire field installation. Provide spade terminals crimped to the lead wires and sized for a #10 screw connection to the existing terminal block in a standard pedestrian signal housing. Do not provide other types of crimped terminals with a spade adapter.

Ensure the power supply is integral to the module assembly. On the back of the module, permanently mark the date of manufacture (month & year) or some other method of identifying date of manufacture.

Provide modules in the following configuration: 16-inch displays which have the solid hand/walking man overlay on the left and the countdown on the right, and 12-inch displays which have the solid hand/walking man module as an overlay. All makes and models of LED modules purchased for use on the State Highway System shall appear on the current NCDOT Traffic Signal Qualified Products List (QPL).

Provide the manufacturer's model number and the product number (assigned by the Department) for each module that appears on the 2024 or most recent Qualified Products List. In addition, provide manufacturer's certification in accordance with Article 106-3 of the *Standard Specifications*, that each module meets or exceeds the ITE "Pedestrian Traffic Control Signal Indicators - Light Emitting Diode (LED) Signal Modules" dated August 04, 2010 (hereafter referred to as PTCSI Pedestrian Standard) and other requirements stated in this specification.

Provide modules that meet the following requirements when tested under the procedures outlined in the PTCSI Pedestrian Standard:

Module Type	Max. Wattage at 165° F	Nominal Wattage at 77° F
Hand Indication	16	13
Walking Man Indication	12	9
Countdown Indication	16	13

Note: Use a wattmeter having an accuracy of $\pm 1\%$ to measure the nominal wattage and maximum wattage of a circular traffic signal module. Power may also be derived from voltage, current and power factor measurements.

Provide module lens that is hard coated or otherwise made to comply with the material exposure and weathering effects requirements of the Society of Automotive Engineers (SAE) J576. Ensure all exposed components of the module are suitable for prolonged exposure to the environment, without appreciable degradation that would interfere with function or appearance.

Ensure the countdown display continuously monitors the traffic controller to automatically learn the pedestrian phase time and update for subsequent changes to the pedestrian phase time.

Ensure the countdown display begins normal operation upon the completion of the preemption sequence and no more than one pedestrian clearance cycle.

3. CONTROLLERS WITH CABINETS

3.1. MATERIALS – TYPE 2070LX CONTROLLERS

Furnish model 2070LX controller units that conform to CALTRANS *Transportation Electrical Equipment Specifications* (TEES) (dated March 12, 2009, plus Errata 1 dated January 21, 2010 and Errata 2 dated December 5, 2014) except as required herein.

The Department will provide software at the beginning of the burning-in period. Contractor shall give 5 working days notice before needing software. Program software provided by the Department.

Provide model 2070LX controllers with Linux kernel 2.6.18 or higher and device drivers, composed of the unit chassis and at a minimum the following modules and assemblies:

- MODEL 2070-1C, CPU Module, Single Board, with 8Mb Datakey (blue in color)
- MODEL 2070-2E+, Field I/O Module (FI/O)
 - Note: Configure the Field I/O Module to disable both the External WDT Shunt/Toggle Switch and SP3 (SP3 active indicator is “off”)
- MODEL 2070-3B, Front Panel Module (FP), Display B (8x40)
- MODEL 2070-4A, Power Supply Module, 10 AMP

Provide a Board Support Package (BSP) to the state and to any specified applications software manufacturer when requested by the state to facilitate the porting of application software.

3.2.MATERIALS – GENERAL CABINETS

Provide a moisture resistant coating on all circuit boards.

Provide one 20 mm diameter radial lead UL-recognized metal oxide varistor (MOV) between each load switch field terminal and equipment ground. Electrical performance is outlined below.

PROPERTIES OF MOV SURGE PROTECTOR	
Maximum Continuous Applied Voltage at 185° F	150 VAC (RMS) 200 VDC
Maximum Peak 8x20µs Current at 185° F	6500 A
Maximum Energy Rating at 185° F	80 J
Voltage Range 1 mA DC Test at 77° F	212-268 V
Max. Clamping Voltage 8x20µs, 100A at 77° F	395 V
Typical Capacitance (1 MHz) at 77° F	1600 pF

Provide a power line surge protector that is a two-stage device that will allow connection of the radio frequency interference filter between the stages of the device. Ensure that a maximum continuous current is at least 10A at 120V. Ensure that the device can withstand a minimum of 20 peak surge current occurrences at 20,000A for an 8x20 microsecond waveform. Provide a maximum clamp voltage of 395V at 20,000A with a nominal series inductance of 200µh. Ensure that the voltage does not exceed 395V. Provide devices that comply with the following:

Frequency (Hz)	Minimum Insertion Loss (dB)
60	0
10,000	30
50,000	55
100,000	50
500,000	50
2,000,000	60
5,000,000	40
10,000,000	20
20,000,000	25

3.3. MATERIALS – TYPE 170E CABINETS

A. Type 170 E Cabinets General:

Conform to the city of Los Angeles’ Specification No. 54-053-08, *Traffic Signal Cabinet Assembly Specification* (dated July 2008), except as required herein.

Furnish model 336S pole mounted cabinets configured for 8 vehicle phases, 4 pedestrian phases, and 6 overlaps. Do not reassign load switches to accommodate overlaps unless shown on electrical details. Provide 336S pole mounted cabinets that are 46” high with 40” high internal rack assemblies.

Furnish model 332 base mounted cabinets configured for 8 vehicle phases, 4 pedestrian phases, and 6 overlaps. When overlaps are required, provide auxiliary output files for the overlaps. Do not reassign load switches to accommodate overlaps unless shown on electrical details.

Provide model 200 load switches, model 222 loop detector sensors, model 252 AC isolators, and model 242 DC isolators according to the electrical details. As a minimum, provide one (1) model 2018 conflict monitor, one (1) model 206L power supply unit, two (2) model 204 flashers, one (1) DC isolator (located in slot I14), and four (4) model 430 flash transfer relays (provide seven (7) model 430 flash transfer relays if auxiliary output file is installed) with each cabinet.

B. Type 170 E Cabinet Electrical Requirements:

Provide a cabinet assembly designed to ensure that upon leaving any cabinet switch or conflict monitor initiated flashing operation, the controller starts up in the programmed start up phases and start up interval.

Furnish two sets of non-fading cabinet wiring diagrams and schematics in a paper envelope or container and placed in the cabinet drawer.

All AC+ power is subject to radio frequency signal suppression.

Provide surge suppression in the cabinet for each type of cabinet device. Provide surge protection for the full capacity of the cabinet input file. Provide surge suppression devices that operate properly over a temperature range of -40° F to +185° F. Ensure the surge suppression devices provide both common and differential modes of protection.

Provide a pluggable power line surge protector that is installed on the back of the PDA (power distribution assembly) chassis to filter and absorb power line noise and switching transients. Ensure the device incorporates LEDs for failure indication and provides a dry relay contact closure for the purpose of remote sensing. Ensure the device meets the following specifications:

- Peak Surge Current (Single pulse, 8x20µs).....20,000A
- Occurrences (8x20µs waveform).....10 minimum @ 20,000A
- Maximum Clamp Voltage.....395VAC
- Operating Current.....15 amps
- Response Time.....< 5 nanoseconds

Provide a loop surge suppressor for each set of loop terminals in the cabinet. Ensure the device meets the following specifications:

- Peak Surge Current (6 times, 8x20µs)
 - (Differential Mode).....400A
 - (Common Mode).....1,000A
- Occurrences (8x20µs waveform).....500 min @ 200A
- Maximum Clamp Voltage
 - (Differential Mode @400A).....35V
 - (Common Mode @1,000A).....35V
- Response Time.....< 5 nanoseconds
- Maximum Capacitance.....35 pF

U-3609B

TS-12

Wayne County

Provide a data communications surge suppressor for each communications line entering or leaving the cabinet. Ensure the device meets the following specifications:

- Peak Surge Current (Single pulse, 8x20µs).....10,000A
- Occurrences (8x20µs waveform).....100 min @ 2,000A
- Maximum Clamp Voltage.....Rated for equipment protected
- Response Time.....< 1 nanosecond
- Maximum Capacitance.....1,500 pF
- Maximum Series Resistance.....15Ω

Provide a DC signal surge suppressor for each DC input channel in the cabinet. Ensure the device meets the following specifications:

- Peak Surge Current (Single pulse, 8x20µs).....10,000A
- Occurrences (8x20µs waveform).....100 @ 2,000A
- Maximum Clamp Voltage.....30V
- Response Time.....< 1 nanosecond

Provide a 120 VAC signal surge suppressor for each AC+ interconnect signal input. Ensure the device meets the following specifications:

- Peak Surge Current (Single pulse, 8x20µs).....20,000A
- Maximum Clamp Voltage.....350VAC
- Response Time.....< 200 nanoseconds
- Discharge Voltage.....<200 Volts @ 1,000A
- Insulation Resistance.....≥100 MΩ

Provide conductors for surge protection wiring that are of sufficient size (ampacity) to withstand maximum overcurrents which could occur before protective device thresholds are attained and current flow is interrupted.

If additional surge protected power outlets are needed to accommodate fiber transceivers, modems, etc., install a UL listed, industrial, heavy-duty type power outlet strip with a minimum rating of 15 A / 125 VAC, 60 Hz. Provide a strip that has a minimum of 3 grounded outlets. Ensure the power outlet strip plugs into one of the controller unit receptacles located on the rear of the PDA. Ensure power outlet strip is mounted securely; provide strain relief if necessary.

Provide a door switch in the front and a door switch in the rear of the cabinet that will provide the controller unit with a Door Ajar alarm when either the front or the rear door is open. Ensure the door switches apply DC ground to the Input File when either the front door or the rear door is open.

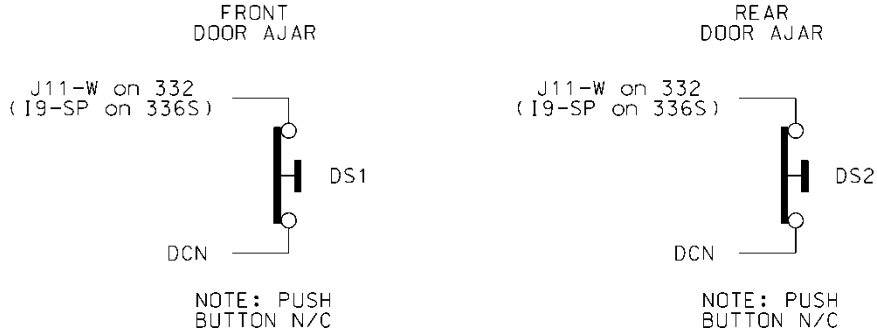

Furnish a fluorescent fixture in the rear across the top of the cabinet and another fluorescent fixture in the front across the top of the cabinet at a minimum. Ensure that the fixtures provide sufficient light to illuminate all terminals, labels, switches, and devices in the cabinet. Conveniently locate the fixtures so as not to interfere with a technician's ability to perform work on any devices or terminals in the cabinet. Provide a protective diffuser to cover exposed bulbs. Install 16 watt T-4 lamps in the fluorescent fixtures. Provide a door switch to provide power to each fixture when the respective door is open. Wire the fluorescent fixtures to the 15 amp ECB (equipment circuit breaker).

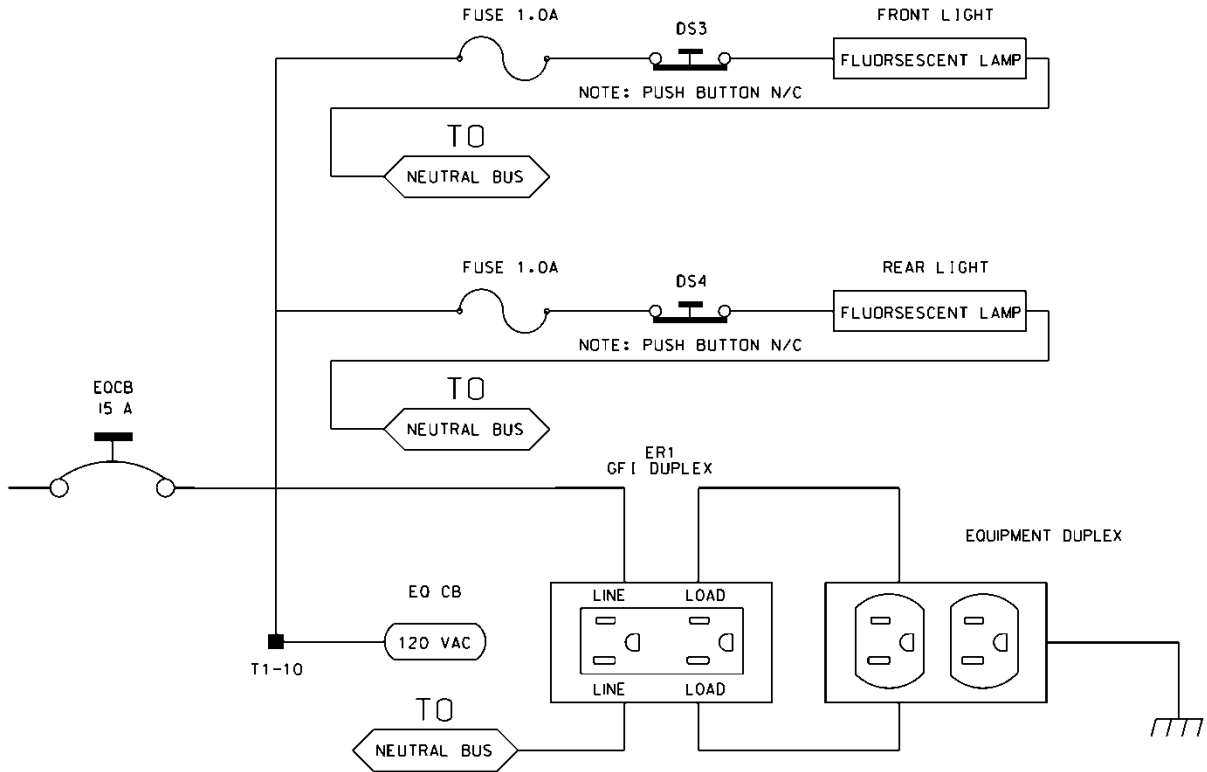

Furnish a police panel with a police panel door. For model 336S cabinets, mount the police panel on the rear door. Ensure that the police panel door permits access to the police panel when the main door is closed. Ensure that no rainwater can enter the cabinet even with the police panel door open. Provide a police panel door hinged on the right side as viewed from the front. Provide a police panel

door lock that is keyed to a standard police/fire call box key. In addition to the requirements of LA Specification No. 54-053-08, provide the police panel with a toggle switch connected to switch the intersection operation between normal stop-and-go operation (AUTO) and manual operation (MANUAL). Ensure that manual control can be implemented using inputs and software such that the controller provides full programmed clearance times for the yellow clearance and red clearance for each phase while under manual control.

Provide a 1/4-inch locking phone jack in the police panel for a hand control to manually control the intersection. Provide sufficient room in the police panel for storage of a hand control and cord.

Ensure the 336S cabinet Input File is wired as follows:

336S Cabinet														
Port-Bit/C-1 Pin Assignment														
Slot #	1	2	3	4	5	6	7	8	9	10	11	12	13	14
C-1 (Spares)	59	60	61	62	63	64	65	66	75	76	77	78	79	80
Port C-1	3-2	1-1	3-4	1-3	3-1	1-2	3-3	1-4	2-5	5-5	5-6	5-1	5-2	6-7
C-1	56	39	58	41	55	40	57	42	51	71	72	67	68	81
Port C-1	2-1	1-5	2-3	1-7	2-2	1-6	2-4	1-8	2-6	5-7	5-8	5-3	5-4	6-8
C-1	47	43	49	45	48	44	50	46	52	73	74	69	70	82

For model 332 base mounted cabinets, ensure terminals J14-E and J14-K are wired together on the rear of the Input File. Connect TB9-12 (J14 Common) on the Input Panel to T1-2 (AC-) on the rear of the PDA.

Provide detector test switches mounted at the top of the cabinet rack or other convenient location which may be used to place a call on each of eight phases based on the chart below. Provide three positions for each switch: On (place call), Off (normal detector operation), and Momentary On (place momentary call and return to normal detector operation after switch is released). Ensure that the switches are located such that the technician can read the controller display and observe the intersection.

Connect detector test switches for cabinets as follows:

336S Cabinet		332 Cabinet	
Detector Call Switches	Terminals	Detector Call Switches	Terminals
Phase 1	I1-F	Phase 1	I1-W
Phase 2	I2-F	Phase 2	I4-W
Phase 3	I3-F	Phase 3	I5-W
Phase 4	I4-F	Phase 4	I8-W
Phase 5	I5-F	Phase 5	J1-W
Phase 6	I6-F	Phase 6	J4-W
Phase 7	I7-F	Phase 7	J5-W
Phase 8	I8-F	Phase 8	J8-W

Provide the PCB 28/56 connector for the conflict monitor unit (CMU) with 28 independent contacts per side, dual-sided with 0.156 inch contact centers. Provide the PCB 28/56 connector contacts with solder eyelet terminations. Ensure all connections to the PCB 28/56 connector are soldered to the solder eyelet terminations.

Ensure that all cabinets have the CMU connector wired according to the 332 cabinet connector pin assignments (include all wires for auxiliary output file connection). Wire pins 13, 16, R, and U of the CMU connector to a separate 4 pin plug, P1, as shown below. Provide a second plug, P2, which will mate with P1 and is wired to the auxiliary output file as shown below. Provide an additional plug, P3, which will mate with P1 and is wired to the pedestrian yellow circuits as shown below. When no auxiliary output file is installed in the cabinet, provide wires for the green and yellow inputs for channels 11, 12, 17, and 18, the red inputs for channels 17 and 18, and the wires for the P2 plug. Terminate the two-foot wires with ring type lugs, insulated, and bundled for optional use.

PIN	P1		P2		P3	
	FUNCTION	CONN TO	FUNCTION	CONN TO	FUNCTION	CONN TO
1	CH-9G	CMU-13	OLA-GRN	A123	2P-YEL	114
2	CH-9Y	CMU-16	OLA-YEL	A122	4P-YEL	105
3	CH-10G	CMU-R	OLB-GRN	A126	6P-YEL	120
4	CH-10Y	CMU-U	OLB-YEL	A125	8P-YEL	111

Do not provide the P20 terminal assembly (red monitor board) or red interface ribbon cable as specified in LA Specification No. 54-053-08.

Provide a P20 connector that mates with and is compatible with the red interface connector mounted on the front of the conflict monitor. Ensure that the P20 connector and the red interface connector on the conflict monitor are center polarized to ensure proper connection. Ensure that removal of the P20 connector will cause the conflict monitor to recognize a latching fault condition and place the cabinet into flashing operation.

Wire the P20 connector to the output file and auxiliary output file using 22 AWG stranded wires. Ensure the length of these wires is a minimum of 42 inches in length. Provide a durable braided sleeve around the wires to organize and protect the wires.

Wire the P20 connector to the traffic signal red displays to provide inputs to the conflict monitor as shown below. Ensure the pedestrian Don't Walk circuits are wired to channels 13 through 16 of the P20 connector. When no auxiliary output file is installed in the cabinet, provide wires for channels 9 through 12 reds. Provide a wire for special function 1. Terminate the unused wires with ring type lugs, insulated, and bundled for optional use.

P20 Connector					
PIN	FUNCTION	CONN TO	PIN	FUNCTION	CONN TO
1	Channel 15 Red	119	2	Channel 16 Red	110
3	Channel 14 Red	104	4	Chassis GND	01-9

5	Channel 13 Red	113	6	N/C	
7	Channel 12 Red	AUX 101	8	Spec Function 1	
9	Channel 10 Red	AUX 124	10	Channel 11 Red	AUX 114
11	Channel 9 Red	AUX 121	12	Channel 8 Red	107
13	Channel 7 Red	122	14	Channel 6 Red	134
15	Channel 5 Red	131	16	Channel 4 Red	101
17	Channel 3 Red	116	18	Channel 2 Red	128
19	Channel 1 Red	125	20	Red Enable	01-14

Ensure the controller unit outputs to the auxiliary output file are pre-wired to the C5 connector. When no auxiliary output file is installed in the cabinet, connect the C5 connector to a storage socket located on the Input Panel or on the rear of the PDA.

Do not wire pin 12 of the load switch sockets.

In addition to the requirements of LA Specification No. 54-053-08, ensure relay K1 on the Power Distribution Assembly (PDA) is a four pole relay and K2 on the PDA is a two pole relay.

Provide a two pole, ganged circuit breaker for the flash bus circuit. Ensure the flash bus circuit breaker is an inverse time circuit breaker rated for 10 amps at 120 VAC with a minimum of 10,000 RMS symmetrical amperes short circuit current rating. Do not provide the auxiliary switch feature on the flash bus circuit breaker. Ensure the ganged flash bus circuit breaker is certified by the circuit breaker manufacturer to provide gang tripping operation.

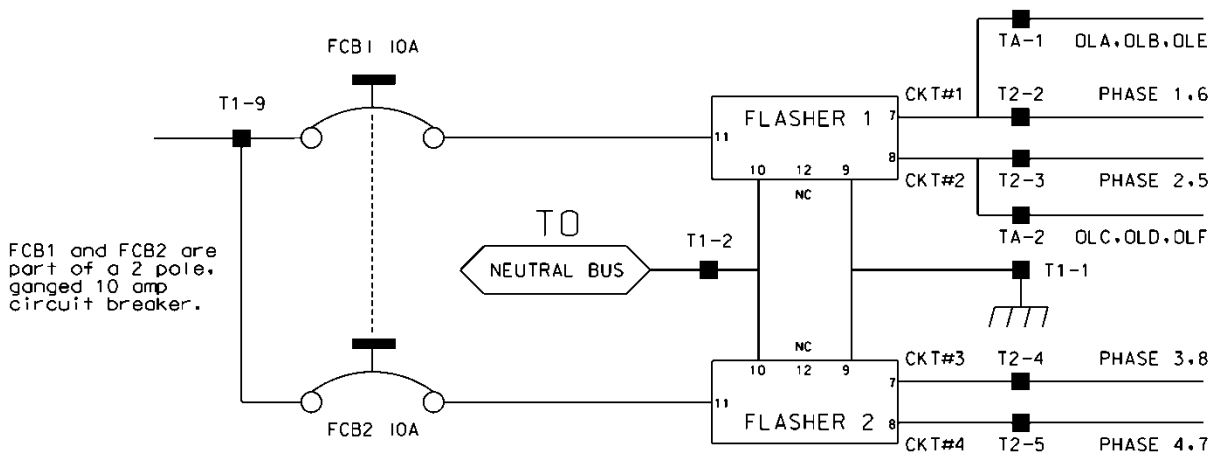

Ensure auxiliary output files are wired as follows:

AUXILIARY OUTPUT FILE TERMINAL BLOCK TA ASSIGNMENTS	
POSITION	FUNCTION
1	Flasher Unit #1, Circuit 1/FTR1 (OLA, OLB)/FTR3 (OLE)
2	Flasher Unit #1, Circuit 2/FTR2 (OLC, OLD)/FTR3 (OLF)
3	Flash Transfer Relay Coils
4	AC -
5	Power Circuit 5
6	Power Circuit 5
7	Equipment Ground Bus
8	NC

Provide four spare load resistors mounted in each cabinet. Ensure each load resistor is rated as shown in the table below. Wire one side of each load resistor to AC-. Connect the other side of each resistor to a separate terminal on a four (4) position terminal block. Mount the load resistors and terminal block either inside the back of Output File No. 1 or on the upper area of the Service Panel.

ACCEPTABLE LOAD RESISTOR VALUES	
VALUE (ohms)	WATTAGE
1.5K – 1.9 K	25W (min)
2.0K – 3.0K	10W (min)

Provide Model 200 load switches, Model 204 flashers, Model 242 DC isolators, Model 252 AC isolators, and Model 206L power supply units that conform to CALTRANS’ *“Transportation Electrical Equipment Specifications”* dated March 12, 2009 with Erratum 1.

C. Type 170 E Cabinet Physical Requirements:

Do not mold, cast, or scribe the name “City of Los Angeles” on the outside of the cabinet door as specified in LA Specification No. 54-053-08. Do not provide a Communications Terminal Panel as specified in LA Specification No. 54-053-08. Do not provide terminal block TBB on the Service Panel. Do not provide Cabinet Verification Test Program software or associated test jigs as specified in LA Specification No. 54-053-08.

Furnish unpainted, natural, aluminum cabinet shells. Ensure that all non-aluminum hardware on the cabinet is stainless steel or a Department approved non-corrosive alternate.

Ensure the lifting eyes, gasket channels, police panel, and all supports welded to the enclosure and doors are fabricated from 0.125 inch minimum thickness aluminum sheet and meet the same standards as the cabinet and doors.

Provide front and rear doors with latching handles that allow padlocking in the closed position. Furnish 0.75 inch minimum diameter stainless steel handles with a minimum 0.5 inch shank. Place

U-3609B**TS-18****Wayne County**

the padlocking attachment at 4.0 inches from the handle shank center to clear the lock and key. Provide an additional 4.0 inches minimum gripping length.

Provide Corbin #2 locks on the front and rear doors. Provide one (1) Corbin #2 and one (1) police master key with each cabinet. Ensure main door locks allow removal of keys in the locked position only.

Provide a surge protection panel with 16 loop surge protection devices and designed to allow sufficient free space for wire connection/disconnection and surge protection device replacement. For model 332 cabinets, provide an additional 20 loop surge protection devices. Provide an additional two AC+ interconnect surge devices to protect one slot and eight DC surge protection devices to protect four slots. Provide no protection devices on slot I14.

For pole mounted cabinets, mount surge protection devices for the AC+ interconnect inputs, inductive loop detector inputs, and low voltage DC inputs on a swing down panel assembly fabricated from sturdy aluminum. Attach the swing down panel to the bottom rear cabinet rack assembly using thumb screws. Ensure the swing down panel allows for easy removal of the input file without removing the surge protection panel assembly or its parts. Have the surge protection devices mounted horizontally on the panel and soldered to the feed through terminals of four 14 position terminal blocks with #8 screws mounted on the other side. Ensure the top row of terminals is connected to the upper slots and the bottom row of terminals is connected to the bottom slots. Provide a 15 position copper equipment ground bus attached to the field terminal side (outside) of the swing down panel for termination of loop lead-in shield grounds. Ensure that a Number 4 AWG green wire connects the surge protection panel assembly ground bus to the main cabinet equipment ground.

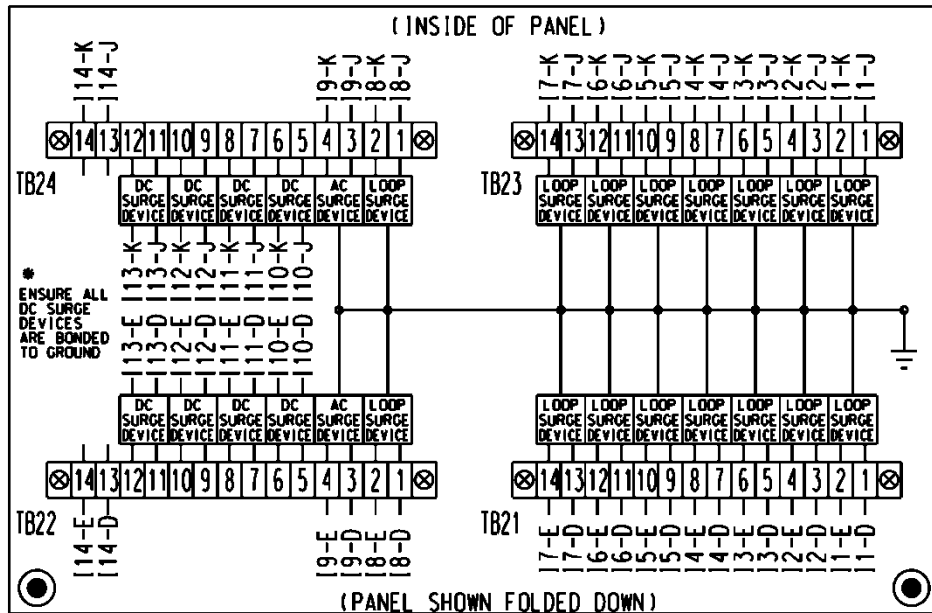
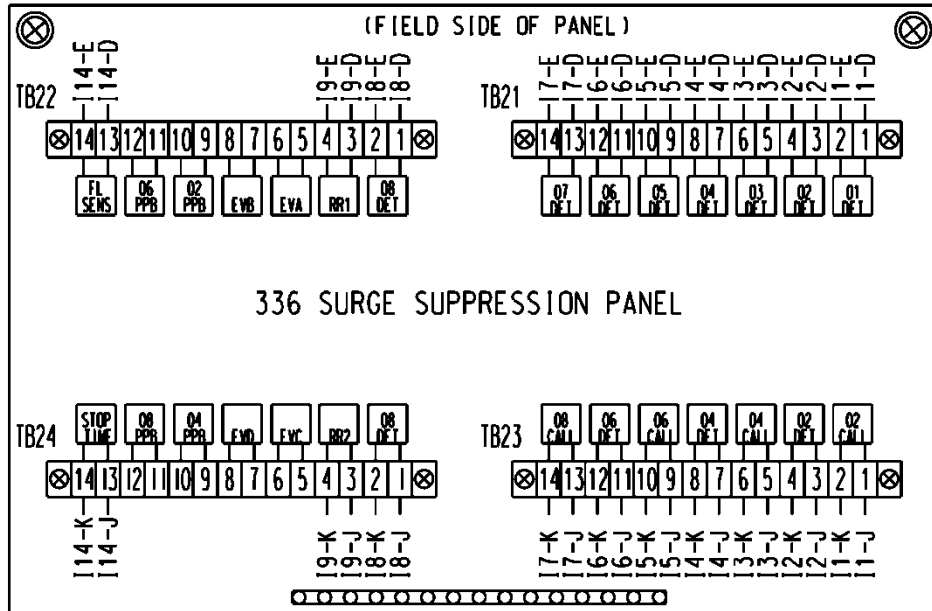

For base mounted cabinets, mount surge protection panels on the left side of the cabinet as viewed from the rear. Attach each panel to the cabinet rack assembly using bolts and make it easily removable. Mount the surge protection devices in vertical rows on each panel and connect the devices to one side of 12 position, double row terminal blocks with #8 screws. For each surge protection panel, terminate all grounds from the surge protection devices on a copper equipment ground bus attached to the surge protection panel. Wire the terminals to the rear of a standard input file using spade lugs for input file protection.

Provide permanent labels that indicate the slot and the pins connected to each terminal that may be viewed from the rear cabinet door. Label and orient terminals so that each pair of inputs is next to each other. Indicate on the labeling the input file (I or J), the slot number (1-14) and the terminal pins of the input slots (either D & E for upper or J & K for lower).

Provide a minimum 14 x 16 inch pull out, hinged top shelf located immediately below controller mounting section of the cabinet. Ensure the shelf is designed to fully expose the table surface outside the controller at a height approximately even with the bottom of the controller. Ensure the shelf has a storage bin interior which is a minimum of 1 inch deep and approximately the same dimensions as the shelf. Provide an access to the storage area by lifting the hinged top of the shelf. Fabricate the shelf and slide from aluminum or stainless steel and ensure the assembly can support the 2070L controller plus 15 pounds of additional weight. Ensure shelf has a locking mechanism to secure it in the fully extended position and does not inhibit the removal of the 2070L controller or removal of cards inside the controller when fully extended. Provide a locking mechanism that is easily released when the shelf is to be returned to its non-use position directly under the controller.

D. Model 2018 Enhanced Conflict Monitor:

Furnish Model 2018 Enhanced Conflict Monitors that provide monitoring of 18 channels. Ensure each channel consists of a green, yellow, and red field signal input. Ensure that the conflict monitor meets or exceeds CALTRANS' Transportation Electrical Equipment Specifications dated March 12, 2009, with Erratum 1 (hereafter referred to as CALTRANS' 2009 TEES) for a model 210 monitor unit and other requirements stated in this specification.

Ensure the conflict monitor is provided with an 18 channel conflict programming card. Pin EE and Pin T of the conflict programming card shall be connected together. Pin 16 of the conflict programming card shall be floating. Ensure that the absence of the conflict programming card will cause the conflict monitor to trigger (enter into fault mode), and remain in the triggered state until the programming card is properly inserted and the conflict monitor is reset.

Provide a conflict monitor that incorporates LED indicators into the front panel to dynamically display the status of the monitor under normal conditions and to provide a comprehensive review of field inputs with monitor status under fault conditions. Ensure that the monitor indicates the channels that were active during a conflict condition and the channels that experienced a failure for all other per channel fault conditions detected. Ensure that these indications and the status of each channel are retained until the Conflict Monitor is reset. Furnish LED indicators for the following:

- AC Power (Green LED indicator)
- VDC Failed (Red LED indicator)
- WDT Error (Red LED indicator)
- Conflict (Red LED indicator)
- Red Fail (Red LED indicator)
- Dual Indication (Red LED indicator)
- Yellow/Clearance Failure (Red LED indicator)
- PCA/PC Ajar (Red LED indicator)
- Monitor Fail/Diagnostic Failure (Red LED indicator)
- 54 Channel Status Indicators (1 Red, 1 Yellow, and 1 Green LED indicator for each of the 18 channels)

U-3609B**TS-21****Wayne County**

Provide a switch to set the Red Fail fault timing. Ensure that when the switch is in the ON position the Red Fail fault timing value is set to 1350 +/- 150 ms (2018 mode). Ensure that when the switch is in the OFF position the Red Fail fault timing value is set to 850 +/- 150 ms (210 mode).

Provide a switch to set the Watchdog fault timing. Ensure that when the switch is in the ON position the Watchdog fault timing value is set to 1.0 +/- 0.1 s (2018 mode). Ensure that when the switch is in the OFF position the Watchdog fault timing value is set to 1.5 +/- 0.1 s (210 mode).

Provide a jumper or switch to set the AC line brown-out levels. Ensure that when the jumper is present or the switch is in the ON position the AC line dropout voltage threshold is 98 +/- 2 Vrms, the AC line restore voltage threshold is 103 +/- 2 Vrms, and the AC line brown-out timing value is set to 400 +/- 50ms (2018 mode). Ensure that when the jumper is not present or the switch is in the OFF position the AC line dropout voltage threshold is 92 +/- 2 Vrms, the AC line restore voltage threshold is 98 +/- 2 Vrms, and the AC line brown-out timing value is set to 80 +/- 17 ms (210 mode).

Provide a jumper or switch that will enable and disable the Watchdog Latch function. Ensure that when the jumper is not present or the switch is in the OFF position the Watchdog Latch function is disabled. In this mode of operation, a Watchdog fault will be reset following a power loss, brownout, or power interruption. Ensure that when the jumper is present or the switch is in the ON position the Watchdog Latch function is enabled. In this mode of operation, a Watchdog fault will be retained until a Reset command is issued.

Provide a jumper that will reverse the active polarity for pin #EE (output relay common). Ensure that when the jumper is not present pin #EE (output relay common) will be considered 'Active' at a voltage greater than 70 Vrms and 'Not Active' at a voltage less than 50 Vrms (Caltrans mode). Ensure that when the jumper is present pin #EE (output relay common) will be considered 'Active' at a voltage less than 50 Vrms and 'Not Active' at a voltage greater than 70 Vrms (Failsafe mode).

In addition to the connectors required by CALTRANS' 2009 TEES, provide the conflict monitor with a red interface connector mounted on the front of the monitor. Ensure the connector is a 20 pin, right angle, center polarized, male connector with latching clip locks and polarizing keys. Ensure the right angle solder tails are designed for a 0.062" thick printed circuit board. Keying of the connector shall be between pins 3 and 5, and between 17 and 19. Ensure the connector has two rows of pins with the odd numbered pins on one row and the even pins on the other row. Ensure the connector pin row spacing is 0.10" and pitch is 0.10". Ensure the mating length of the connector pins is 0.24". Ensure the pins are finished with gold plating 30μ" thick.

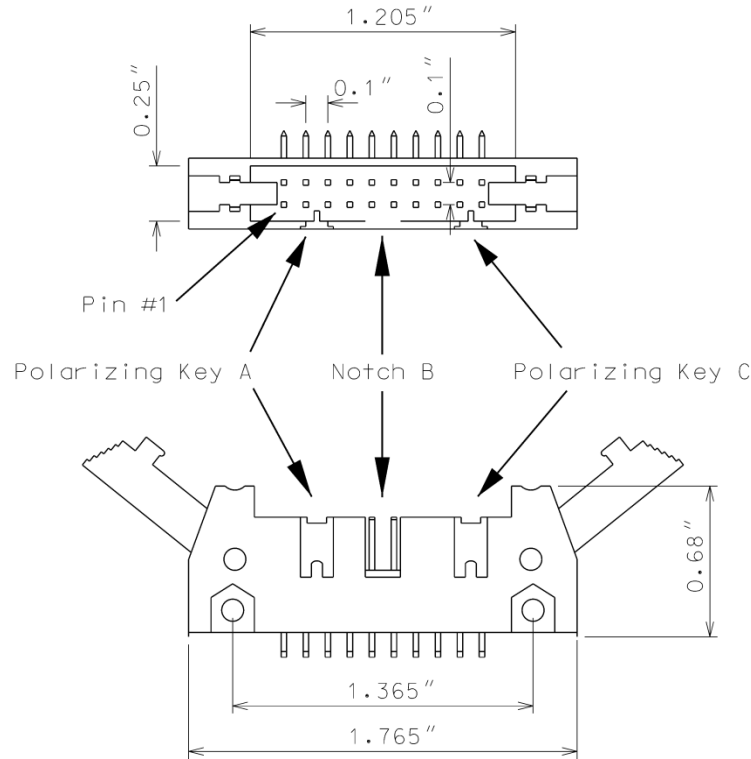

Ensure the red interface connector pins on the monitor have the following functions:

Pin #	Function	Pin #	Function
1	Channel 15 Red	2	Channel 16 Red
3	Channel 14 Red	4	Chassis Ground
5	Channel 13 Red	6	Special Function 2
7	Channel 12 Red	8	Special Function 1
9	Channel 10 Red	10	Channel 11 Red
11	Channel 9 Red	12	Channel 8 Red
13	Channel 7 Red	14	Channel 6 Red
15	Channel 5 Red	16	Channel 4 Red
17	Channel 3 Red	18	Channel 2 Red
19	Channel 1 Red	20	Red Enable

Ensure that removal of the P20 cable connector will cause the conflict monitor to recognize a latching fault condition and place the cabinet into flashing operation.

Provide Special Function 1 and Special Function 2 inputs to the unit which shall disable only Red Fail Monitoring when either input is sensed active. A Special Function input shall be sensed active when the input voltage exceeds 70 Vrms with a minimum duration of 550 ms. A Special Function input shall be sensed not active when the input voltage is less than 50 Vrms or the duration is less

than 250 ms. A Special Function input is undefined by these specifications and may or may not be sensed active when the input voltage is between 50 Vrms and 70 Vrms or the duration is between 250 ms and 550 ms.

Ensure the conflict monitor recognizes field signal inputs for each channel that meet the following requirements:

- consider a Red input greater than 70 Vrms and with a duration of at least 500 ms as an “on” condition;
- consider a Red input less than 50 Vrms or with a duration of less than 200 ms as an “off” condition (no valid signal);
- consider a Red input between 50 Vrms and 70 Vrms or with a duration between 200 ms and 500 ms to be undefined by these specifications;
- consider a Green or Yellow input greater than 25 Vrms and with a duration of at least 500 ms as an “on” condition;
- consider a Green or Yellow input less than 15 Vrms or with a duration of less than 200 ms as an “off” condition; and
- consider a Green or Yellow input between 15 Vrms and 25 Vrms or with a duration between 200 ms and 500 ms to be undefined by these specifications.

Provide a conflict monitor that recognizes the faults specified by CALTRANS’ 2009 TEES and the following additional faults. Ensure the conflict monitor will trigger upon detection of a fault and will remain in the triggered (in fault mode) state until the unit is reset at the front panel or through the external remote reset input for the following failures:

1. **Red Monitoring or Absence of Any Indication (Red Failure):** A condition in which no “on” voltage signal is detected on any of the green, yellow, or red inputs to a given monitor channel. If a signal is not detected on at least one input (R, Y, or G) of a conflict monitor channel for a period greater than 1000 ms when used with a 170 controller and 1500 ms when used with a 2070 controller, ensure monitor will trigger and put the intersection into flash. If the absence of any indication condition lasts less than 700 ms when used with a 170 controller and 1200 ms when used with a 2070 controller, ensure conflict monitor will not trigger. Red fail monitoring shall be enabled on a per channel basis by the use of switches located on the conflict monitor. Have red monitoring occur when all of the following input conditions are in effect:
 - a) Red Enable input to monitor is active (Red Enable voltages are “on” at greater than 70 Vrms, off at less than 50 Vrms, undefined between 50 and 70 Vrms), and
 - b) Neither Special Function 1 nor Special Function 2 inputs are active.
 - c) Pin #EE (output relay common) is not active
2. **Short/Missing Yellow Indication Fault (Clearance Error):** Yellow indication following a green is missing or shorter than 2.7 seconds (with ± 0.1 -second accuracy). If a channel fails to detect an “on” signal at the Yellow input for a minimum of 2.7 seconds (± 0.1 second) following the detection of an “on” signal at a Green input for that channel, ensure that the monitor triggers and generates a clearance/short yellow error fault indication. Short/missing

yellow (clearance) monitoring shall be enabled on a per channel basis by the use of switches located on the conflict monitor. This fault shall not occur when the channel is programmed for Yellow Inhibit, when the Red Enable signal is inactive or pin #EE (output relay common) is active.

3. **Dual Indications on the Same Channel:** In this condition, more than one indication (R,Y,G) is detected as “on” at the same time on the same channel. If dual indications are detected for a period greater than 500 ms, ensure that the conflict monitor triggers and displays the proper failure indication (Dual Ind fault). If this condition is detected for less than 200 ms, ensure that the monitor does not trigger. G-Y-R dual indication monitoring shall be enabled on a per channel basis by the use of switches located on the conflict monitor. G-Y dual indication monitoring shall be enabled for all channels by use of a switch located on the conflict monitor. This fault shall not occur when the Red Enable signal is inactive or pin #EE (output relay common) is active.
4. **Configuration Settings Change:** The configuration settings are comprised of (as a minimum) the permissive diode matrix, dual indication switches, yellow disable jumpers, any option switches, any option jumpers, and the Watchdog Enable switch. Ensure the conflict monitor compares the current configuration settings with the previous stored configuration settings on power-up, on reset, and periodically during operation. If any of the configuration settings are changed, ensure that the conflict monitor triggers and causes the program card indicator to flash. Ensure that configuration change faults are only reset by depressing and holding the front panel reset button for a minimum of three seconds. Ensure the external remote reset input does not reset configuration change faults.

Ensure the conflict monitor will trigger and the AC Power indicator will flash at a rate of $2 \text{ Hz} \pm 20\%$ with a 50% duty cycle when the AC Line voltage falls below the “drop-out” level. Ensure the conflict monitor will resume normal operation when the AC Line voltage returns above the “restore” level. Ensure the AC Power indicator will remain illuminated when the AC voltage returns above the “restore” level. Should an AC Line power interruption occur while the monitor is in the fault mode, then upon restoration of AC Line power, the monitor will remain in the fault mode and the correct fault and channel indicators will be displayed.

Provide a flash interval of at least 6 seconds and at most 16 seconds in duration following a power-up, an AC Line interruption, or a brownout restore. Ensure the conflict monitor will suspend all fault monitoring functions, close the Output relay contacts, and flash the AC indicator at a rate of $4 \text{ Hz} \pm 20\%$ with a 50% duty cycle during this interval. Ensure the termination of the flash interval after at least 6 seconds if the Watchdog input has made 5 transitions between the True and False state and the AC Line voltage is greater than the “restore” level. If the watchdog input has not made 5 transitions between the True and False state within 10 ± 0.5 seconds, the monitor shall enter a WDT error fault condition.

Ensure the conflict monitor will monitor an intersection with a minimum of four approaches using the four-section Flashing Yellow Arrow (FYA) vehicle traffic signal as outlined by the NCHRP 3-54 research project for protected-permissive left turn signal displays. Ensure the conflict monitor will operate in the FYA mode and FYAc (Compact) mode as specified below to monitor each channel pair for the following fault conditions: Conflict, Flash Rate Detection, Red Fail, Dual Indication, and

Clearance. Provide a switch to select between the FYA mode and FYAc mode. Provide a switch to select each FYA phase movement for monitoring.

FYA mode

FYA Signal Head	Phase 1	Phase 3	Phase 5	Phase 7
Red Arrow	Channel 9 Red	Channel 10 Red	Channel 11 Red	Channel 12 Red
Yellow Arrow	Channel 9 Yellow	Channel 10 Yellow	Channel 11 Yellow	Channel 12 Yellow
Flashing Yellow Arrow	Channel 9 Green	Channel 10 Green	Channel 11 Green	Channel 12 Green
Green Arrow	Channel 1 Green	Channel 3 Green	Channel 5 Green	Channel 7 Green

FYAc mode

FYA Signal Head	Phase 1	Phase 3	Phase 5	Phase 7
Red Arrow	Channel 1 Red	Channel 3 Red	Channel 5 Red	Channel 7 Red
Yellow Arrow	Channel 1 Yellow	Channel 3 Yellow	Channel 5 Yellow	Channel 7 Yellow
Flashing Yellow Arrow	Channel 1 Green	Channel 3 Green	Channel 5 Green	Channel 7 Green
Green Arrow	Channel 9 Green	Channel 9 Yellow	Channel 10 Green	Channel 10 Yellow

If a FYA channel pair is enabled for FYA operation, the conflict monitor will monitor the FYA logical channel pair for the additional following conditions:

1. **Conflict:** Channel conflicts are detected based on the permissive programming jumpers on the program card. This operation remains unchanged from normal operation except for the solid Yellow arrow (FYA clearance) signal.
2. **Yellow Change Interval Conflict:** During the Yellow change interval of the Permissive Turn channel (flashing Yellow arrow) the conflict monitor shall verify that no conflicting channels to the solid Yellow arrow channel (clearance) are active. These conflicting channels shall be determined by the program card compatibility programming of the Permissive Turn channel (flashing Yellow arrow). During the Yellow change interval of the Protected Turn channel (solid Green arrow) the conflict monitor shall verify that no conflicting channels to the solid Yellow arrow channel (clearance) are active as determined by the program card compatibility programming of the Protected Turn channel (solid Green arrow).

3. **Flash Rate Detection:** The conflict monitor unit shall monitor for the absence of a valid flash rate for the Permissive turn channel (flashing Yellow arrow). If the Permissive turn channel (flashing Yellow arrow) is active for a period greater than 1600 milliseconds, ensure the conflict monitor triggers and puts the intersection into flash. If the Permissive turn channel (flashing Yellow arrow) is active for a period less than 1400 milliseconds, ensure the conflict monitor does not trigger. Ensure the conflict monitor will remain in the triggered (in fault mode) state until the unit is reset at the front panel or through the external remote reset input. Provide a jumper or switch that will enable and disable the Flash Rate Detection function. Ensure that when the jumper is not present or the switch is in the OFF position the Flash Rate Detection function is enabled. Ensure that when the jumper is present or the switch is in the ON position the Flash Rate Detection function is disabled.
4. **Red Monitoring or Absence of Any Indication (Red Failure):** The conflict monitor unit shall detect a red failure if there is an absence of voltage on all four of the inputs of a FYA channel pair (RA, YA, FYA, GA).
5. **Dual Indications on the Same Channel:** The conflict monitor unit shall detect a dual indication if two or more inputs of a FYA channel pair (RA, YA, FYA, GA) are “on” at the same time.
6. **Short/Missing Yellow Indication Fault (Clearance Error):** The conflict monitor unit shall monitor the solid Yellow arrow for a clearance fault when terminating both the Protected Turn channel (solid Green arrow) interval and the Permissive Turn channel (flashing Yellow arrow) interval.

Ensure that the conflict monitor will log at least nine of the most recent events detected by the monitor in non-volatile EEPROM memory (or equivalent). For each event, record at a minimum the time, date, type of event, status of each field signal indication with RMS voltage, and specific channels involved with the event. Ensure the conflict monitor will log the following events: monitor reset, configuration, previous fault, and AC line. Furnish the signal sequence log that shows all channel states (Greens, Yellows, and Reds) and the Red Enable State for a minimum of 2 seconds prior to the current fault trigger point. Ensure the display resolution of the inputs for the signal sequence log is not greater than 50 ms.

For conflict monitors used within an Ethernet communications system, provide a conflict monitor with an Ethernet 10/100 Mbps, RJ-45 port for data communication access to the monitor by a local notebook computer and remotely via a workstation or notebook computer device connected to the signal system local area network. The Ethernet port shall be electrically isolated from the conflict monitor’s electronics and shall provide a minimum of 1500 Vrms isolation. Integrate monitor with Ethernet network in cabinet. Provide software to retrieve the time and date from a network server in order to synchronize the on-board times between the conflict monitor and the controller. Furnish and install the following Windows based, graphic user interface software on workstations and notebook computers where the signal system client software is installed: 1) software to view and retrieve all event log information, 2) software that will search and display a list of conflict monitor IP addresses and IDs on the network, and 3) software to change the conflict monitor’s network parameters such as IP address and subnet mask.

For non-Ethernet connected monitors, provide a RS-232C/D compliant port (DB-9 female connector) on the front panel of the conflict monitor in order to provide communications from the conflict monitor to the 170/2070 controller or to a Department-furnished laptop computer. Electrically isolate the port interface electronics from all monitor electronics, excluding Chassis Ground. Ensure that the controller can receive all event log information through a controller

U-3609B

TS-27

Wayne County

Asynchronous Communications Interface Adapter (Type 170E) or Async Serial Comm Module (2070). Furnish and connect a serial cable from the conflict monitor’s DB-9 connector to Comm Port 1 of the 2070 controller. Ensure conflict monitor communicates with the controller. Provide a Windows based graphic user interface software to communicate directly through the same monitor RS-232C/D compliant port to retrieve and view all event log information to a Department-furnished laptop computer. The RS-232C/D compliant port on the monitor shall allow the monitor to function as a DCE device with pin connections as follows:

Conflict Monitor RS-232C/D (DB-9 Female) Pinout		
Pin Number	Function	I/O
1	DCD	O
2	TX Data	O
3	RX Data	I
4	DTR	I
5	Ground	-
6	DSR	O
7	CTS	I
8	RTS	O
9	NC	-

U-3609B

TS-28

Wayne County

MONITOR BOARD EDGE CONNECTOR

Pin #	Function (Back Side)	Pin #	Function (Component Side)
1	Channel 2 Green	A	Channel 2 Yellow
2	Channel 13 Green	B	Channel 6 Green
3	Channel 6 Yellow	C	Channel 15 Green
4	Channel 4 Green	D	Channel 4 Yellow
5	Channel 14 Green	E	Channel 8 Green
6	Channel 8 Yellow	F	Channel 16 Green
7	Channel 5 Green	H	Channel 5 Yellow
8	Channel 13 Yellow	J	Channel 1 Green
9	Channel 1 Yellow	K	Channel 15 Yellow
10	Channel 7 Green	L	Channel 7 Yellow
11	Channel 14 Yellow	M	Channel 3 Green
12	Channel 3 Yellow	N	Channel 16 Yellow
13	Channel 9 Green	P	Channel 17 Yellow
14	Channel 17 Green	R	Channel 10 Green
15	Channel 11 Yellow	S	Channel 11 Green
16	Channel 9 Yellow	T	Channel 18 Yellow
17	Channel 18 Green	U	Channel 10 Yellow
--		--	
18	Channel 12 Yellow	V	Channel 12 Green
19	Channel 17 Red	W	Channel 18 Red
20	Chassis Ground	X	Not Assigned
21	AC-	Y	DC Common
22	Watchdog Timer	Z	External Test Reset
23	+24VDC	AA	+24VDC
24	Tied to Pin 25	BB	Stop Time (Output)
25	Tied to Pin 24	CC	Not Assigned
26	Not Assigned	DD	Not Assigned
27	Relay Output, Side #3, N.O.	EE	Relay Output, Side #2, Common
28	Relay Output, Side #1, N.C.	FF	AC+

-- Slotted for keying between Pins 17/U and 18/V

CONFLICT PROGRAM CARD PIN ASSIGNMENTS

Pin #	Function (Back Side)	Pin #	Function (Component Side)
1	Channel 2 Green	A	Channel 1 Green
2	Channel 3 Green	B	Channel 2 Green
3	Channel 4 Green	C	Channel 3 Green
4	Channel 5 Green	D	Channel 4 Green
5	Channel 6 Green	E	Channel 5 Green
6	Channel 7 Green	F	Channel 6 Green
7	Channel 8 Green	H	Channel 7 Green
8	Channel 9 Green	J	Channel 8 Green
9	Channel 10 Green	K	Channel 9 Green
10	Channel 11 Green	L	Channel 10 Green
11	Channel 12 Green	M	Channel 11 Green
12	Channel 13 Green	N	Channel 12 Green
13	Channel 14 Green	P	Channel 13 Green
14	Channel 15 Green	R	Channel 14 Green
15	Channel 16 Green	S	Channel 15 Green
16	N/C	T	PC AJAR
17	Channel 1 Yellow	U	Channel 9 Yellow
18	Channel 2 Yellow	V	Channel 10 Yellow
19	Channel 3 Yellow	W	Channel 11 Yellow
20	Channel 4 Yellow	X	Channel 12 Yellow
21	Channel 5 Yellow	Y	Channel 13 Yellow
22	Channel 6 Yellow	Z	Channel 14 Yellow
23	Channel 7 Yellow	AA	Channel 15 Yellow
24	Channel 8 Yellow	BB	Channel 16 Yellow
--		--	
25	Channel 17 Green	CC	Channel 17 Yellow
26	Channel 18 Green	DD	Channel 18 Yellow
27	Channel 16 Green	EE	PC AJAR (Program Card)
28	Yellow Inhibit Common	FF	Channel 17 Green

-- Slotted for keying between Pins 24/BB and 25/CC

characteristics as shown in the wiring detail in Figure 1. Provide 4 terminal screws with saddle clamps.

Provide fuses F1 and F2 as a UL Listed ¼" x 1-1/4" glass tube rated at 250 volts with a 10kA interrupting rating. Ensure F1 non-delay (fast-acting) and F2 slow-blow (time-delay) fuses have a maximum opening times of 60 minutes and 120 seconds for currents of 135 and 200 percent of the ampere rating, respectively. Ensure F2 slow-blow (time-delay) fuses have a minimum opening times of 12 seconds at 200 percent of the ampere rating. Provide fuse holders that are UL Recognized panel-mounted holders rated 250V, 15 ampere minimum with bayonet-type knobs which accept ¼" x 1-1/4" glass tube fuses.

Provide terminal blocks that are rated for 300V and are made of electrical grade thermoplastic or thermosetting plastic. Ensure each terminal block is of closed back design and has recessed-screw terminals with molded barriers between terminals. Ensure each terminal block is labeled with a block designation. Ensure each terminal is labeled with the function and a number.

Provide 3/4-inch diameter radial lead UL-recognized metal oxide varistors (MOVs) that have electrical performance as outlined below.

PROPERTIES OF MOV SURGE PROTECTOR	
Maximum Continuous Applied Voltage at 185° F	150 VAC (RMS) 200 VDC
Maximum Peak 8x20µs Current at 185° F	6500 A
Maximum Energy Rating at 185° F	80 J
Voltage Range 1 mA DC Test at 77° F	212-268 V
Max. Clamping Voltage 8x20µs, 100A at 77° F	395 V
Typical Capacitance (1 MHz) at 77° F	1600 pF

Provide resistor R1 as a 2K ohm, 12 watt, wirewound resistor with tinned terminals and attaching leads. Ensure the resistor is spaced apart from surrounding wires.

Provide a LED or incandescent lamp that has a voltage rating of 120 VAC with a minimum life rating at 50,000 hours.

Wire the preemption and sign control box as shown in Figure 1.

RAILROAD PREEMPTION WIRING DETAIL

(wire as shown below)

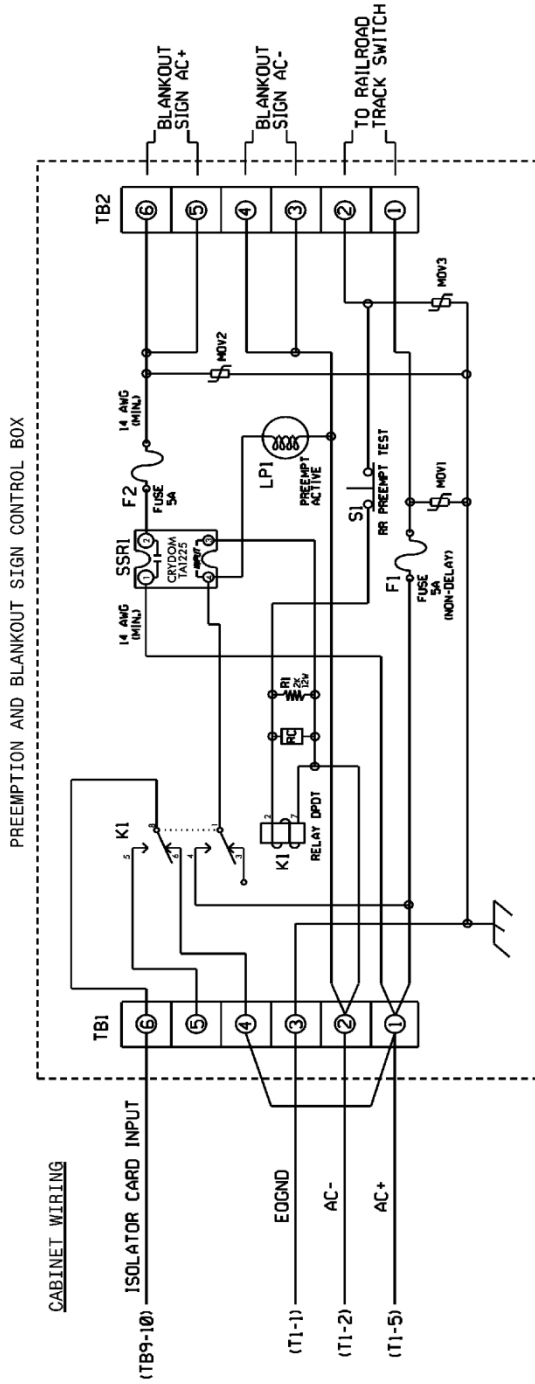

NOTES

1. RELAY K1 IS SHOWN IN THE ENERGIZED (PREEMPT NOI ACTIVE) NORMAL OPERATION STATE.
2. AC ISOLATOR CARD SHALL ACTIVATE PREEMPTION UPON REMOVAL OF AC+ FROM INPUT (AS SHOWN ABOVE). THIS IS ACCOMPLISHED BY SETTING TYPE 252 AC ISOLATOR CARD TO INVERTED OPERATION.

FRONT VIEW

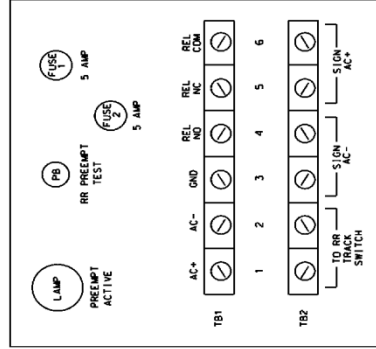

Figure 1

3.4. MATERIALS – TYPE 170 DETECTOR SENSOR UNITS

Furnish detector sensor units that comply with Chapter 5 Section 1, “General Requirements,” and Chapter 5 Section 2, “Model 222 & 224 Loop Detector Sensor Unit Requirements,” of the CALTRANS “Transportation Electrical Equipment Specifications” dated March 12, 2009 with Erratum 1.

4. MICROWAVE VEHICLE DETECTION SYSTEM - MULTIPLE DETECTION ZONES

4.1. DESCRIPTION

Design, furnish and install a microwave vehicle detection system with the manufacturer recommended cables and hardware in accordance to the plans and specifications. Ensure the detection system provides multiple detection zones.

4.2. MATERIALS

Provide design drawings showing design details and microwave sensor locations for review and acceptance before installation. Provide mounting height and location requirements for microwave sensor units on the design based on a site survey. Design microwave vehicle detection system with all necessary hardware. Indicate all necessary poles, spans, mast arms, luminaire arms, cables, microwave sensor mounting assemblies and hardware to achieve the required detection zones where Department owned poles are not adequate to locate the microwave sensor units. Do not design for the installation of poles in medians.

Obtain the Engineer’s approval before furnishing microwave vehicle detection system. The contractor is responsible for the final design of microwave vehicle detection system. Review and acceptance of the designs by the Department does not relieve the contractor from the responsibility to provide fully functional systems and to ensure that the required detection zones can be provided. With the exception of contractor-furnished poles, mast arms, and luminaire arms, furnish material, equipment, and hardware under this section that is pre-approved on the ITS and Signals QPL. Submit and obtain Engineer’s approval of shop drawings for any poles, mast arms, and luminaire arms provided by the contractor prior to ordering from manufacturer.

Provide a detector for either side-fire or forward-fire configuration. Ensure the detector will detect vehicles in sunny, cloudy, rainy, snowy, and foggy weather conditions. Ensure the detector can operate from the voltage supplied by a NEMA TS-1/TS-2 or Type 332 or 336 traffic signal cabinet. Ensure the detector can provide detection calls to the traffic signal controller within a NEMA TS-1/TS-2 or Type 332 or 336 cabinet. Ensure the detection system provides a constant call in the event of a component failure or loss of power. Ensure the detector has an operating temperature range of -30 to 165 degrees F and operates within the frequency range of 10 to 25 GHz. Ensure the detector is provided with a water-tight housing offering NEMA 4X protection and operates properly in up to 95% relative humidity, non-condensing.

Provide each detector unit to allow the placement of at least 8 detection zones with a minimum of 8 detection channel outputs. When the microwave vehicle detection system requires an integrated card rack interface(s), provide only enough interface cards to implement the vehicle detection shown on the signal plans. Provide a means acceptable to the Engineer to configure traffic lanes and detection zones. Provide each channel output with a programmable means to delay the output call upon activation of a detection zone that is adjustable in one second increments (maximum) over the range of 0 to 25 seconds. Provide each channel output with a programmable means to extend the output call that is adjustable in one second increments (maximum) over the range of 0 to 25 seconds. Ensure both delay and extend timing can be set for the same channel output.

For advance detection system, ensure the detector senses vehicles in motion at a range of 50 to 400 feet from the detector unit for forward-fire configuration and a range of 50 to 200 feet from the detector unit for side-fire configuration with an accuracy of 95% for both configurations. Ensure the advance detection system provides each channel output call of at least 100 ms in duration.

For stop bar presence detection system, ensure the detector outputs a constant call while a vehicle is in the detection zone and removes the call after all vehicles exit the detection zone. Ensure the presence detector unit can cover a detection zone as shown on the plans and has an effective range of 10 to 120 feet from the detector unit.

For units without an integrated card rack interface, provide Form C output relay contacts rated a minimum of 3A, 24VDC.

If a laptop is used to adjust detector settings, ensure that software is licensed for use by the Department and by any other agency responsible for maintaining or operating the microwave detection system. Provide the Department with a license to duplicate and distribute the software as necessary for design and maintenance support.

After initial detector configuration and installation, ensure routine adjustments or calibration are not needed to maintain acceptable performance.

4.3. CONSTRUCTION METHODS

Install the microwave vehicle detection system in accordance with the manufacturer’s recommendations.

Monitor and maintain each detector unit during construction to ensure microwave vehicle detection system is functioning properly and aimed for the detection zone shown in the plans. Refer to Subarticle 1700-3 (D) Maintenance and Repair of Materials of the *Standard Specifications* for failure to maintain the microwave detection system.

4.4. MEASUREMENT AND PAYMENT

Actual number of microwave vehicle detection systems – multiple zones furnished, installed, and accepted.

No measurement will be made of cables or hardware, as these will be considered incidental to furnishing and installing microwave vehicle detection systems.

Payment will be made under:

Microwave Vehicle Detection System – Multiple Zones Each

5. METAL POLE SUPPORTS

5.1. METAL POLES

A. General:

Furnish and install metal poles, grounding systems, and all necessary hardware. Work covered under this special provision includes requirements for design, fabrication, and installation of standard and custom/site-specific designed metal pole supports and associated foundations.

Comply with applicable sections of the *2024 STANDARD SPECIFICATIONS FOR ROADS & STRUCTURES*, hereinafter referred to as the *Standard Specifications*. Provide designs of completed assemblies with hardware equaling or exceeding *AASHTO LRFD Specifications for Structural Supports for Highway Signs, Luminaires and Traffic Signals* 1st Edition, 2015 (hereinafter called 1st Edition AASHTO), including the latest interim specifications. Provide assemblies with a round or

near-round (18 sides or more) cross-section, or a multi-sided cross section with no less than six sides. The sides may be straight, convex, or concave.

For bid purposes, pole heights shown on plans are estimated from available data. Prior to furnishing metal poles, use field measurements and adjusted cross-sections to determine whether pole heights will meet required clearances. If pole heights do not meet required clearances, the Contractor should immediately notify the Engineer of the required revised pole heights.

Standard Drawings for Metal Poles are available that supplement these project special provisions. The drawings are located on the Department’s website:

<https://connect.ncdot.gov/resources/safety/pages/ITS-Design-Resources.aspx>

Comply with article 1098-1(B) of the *Standard Specifications* for submittal requirements. Furnish shop drawings for approval. Provide copies of detailed shop drawings for each type of structure as summarized below. Ensure shop drawings include material specifications for each component. Ensure shop drawings identify welds by type and size on the detail drawing only, not in table format. **Do not release structures for fabrication until shop drawings have been approved by NCDOT.** Ensure shop drawings contain an itemized bill of materials for all structural components and associated connecting hardware.

Comply with article 1098-1(A) of the *Standard Specifications* for Qualified Products List (QPL) submittals. All shop drawings must include project location description, signal or asset inventory number(s) and project number or work order number.

Summary of information required for metal pole review submittal:

Item	Electronic Submittal	Comments / Special Instructions
Sealed, Approved Signal or ITS Plan/Loading Diagram	1 set	All structure design information needs to reflect the latest approved Signal or ITS plans
Custom Pole Shop Drawings	1 set	Submit drawings on 11” x 17” format media. Show NCDOT signal or asset inventory number(s), Contractor’s name and relevant revision number in the title block. All drawings must have a <u>unique drawing number</u> for each project.
Standard Strain Pole Shop Drawings (from the QPL)	1 set	Submit drawings on 11” x 17” format media. Show NCDOT signal inventory number(s), Contractor’s name and relevant revision number in the title block. All drawings must have a <u>unique drawing number</u> for each project.
Structure Calculations	1 set	Not required for Standard QPL Poles
Standard Strain Pole Foundation Drawings	1 set	Submit drawings on 11” x 17” format media. Submit a completed Standard Foundation Selection form for each pole using foundation table on Metal Pole Drawing M8.
Custom Foundation Drawings	1 set	Submit drawings on 11” x 17” format media. Show NCDOT signal or asset inventory number(s), Contractor’s name and relevant revision number in the title block. All drawings

		must have a <u>unique drawing number</u> for each project. If QPL Poles are used, include the corresponding QPL pole shop drawings with this submittal.
Foundation Calculations	1 set	Submit copies of LPILE input, output, and pile tip deflection graph per Section titled Drilled Pier Foundations for Metal Poles of this specification for each foundation. Not required for Standard Strain Poles (from the QPL)
Soil Boring Logs and Report	1 set	Report shall include a location plan and a soil classification report including soil capacity, water level, hammer efficiency, soil bearing pressure, soil density, etc. for each pole.

NOTE – All shop drawings and custom foundation design drawings must be sealed by a Professional Engineer licensed in the state of North Carolina. All geotechnical information must be sealed by either a Professional Engineer or Geologist licensed in the state of North Carolina. Include a title block and revision block on the shop drawings and foundation drawings showing the NCDOT signal or asset inventory number(s).

Shop drawings and foundation drawings may be submitted together or separately for approval. However, shop drawings must be approved before foundations can be reviewed. Foundation designs will be returned without review if the associated shop drawing has not been approved. Boring reports shall include the following: Engineer’s summary, boring location maps, soil classification per AASHTO Classification System, hammer efficiency, and Metal Pole Standard Foundation Selection Form. Incomplete submittals will be returned without review. The Reviewer has the right to request additional analysis and copies of the calculations to expedite the approval process.

B. Materials:

Fabricate metal pole from coil or plate steel that meet the requirements of ASTM A 572 Gr 55 or ASTM A 595 Grade A tubes. For structural steel shapes, plates, and bars use, as a minimum, ASTM A572 Gr 50, AASHTO M270 Gr 50, ASTM A709 Gr 50, or an approved equivalent. Provide pole shafts of round or near round (18 sides or more) cross-section, or multi-sided tubular cross-section with no less than six sides, having a uniform linear taper of 0.14 in/ft. Construct shafts from one piece of single-ply plate or coil. For anchor base fabrication, conform to the applicable bolt pattern and orientation as shown on Metal Pole Standard Drawing Sheet M2.

Use the submerged arc process, or other NCDOT previously approved process suitable for shafts, to continuously weld pole shafts along their entire length. Finish the longitudinal seam weld flush with the outside contour of the base metal. Ensure shaft has no circumferential welds except at the lower end joining the shaft to the pole base. Use full penetration groove welds with backing ring for all tube-to-transverse-plate connections in accordance with 1st Edition AASHTO. Provide welding that conforms to Article 1072-18 of the *Standard Specifications*. No field welding on any part of the pole will be permitted unless approved by a qualified Engineer.

After fabrication, hot-dip galvanize steel poles and all assembly components in accordance with section 1076-3 of the *Standard Specifications*. Design structural assemblies with weep holes large enough and properly located to drain molten zinc during the galvanization process. Galvanize hardware in accordance with section 1076-4 of the *Standard Specifications*. Ensure threaded

U-3609B**TS-37****Wayne County**

material is brushed and retapped as necessary after galvanizing. Perform repair of damaged galvanizing in accordance with section 1076-7 of the *Standard Specifications*. Ensure all hardware is galvanized steel or stainless steel. The Contractor is responsible for ensuring the Designer/Fabricator specifies connecting hardware and/or materials that prevent a dissimilar metal corrosive reaction.

Ensure each anchor rod is 2-inch minimum diameter and 60-inch length. Provide 10-inch minimum thread projection at the top of the rod, and 8-inch minimum at the bottom of the rod. Use anchor rod assembly and drilled pier foundation materials complying with SP09_R005, hereinafter referred to as *Foundations and Anchor Rod Assemblies for Metal Poles*.

Ensure anchor bolt hole diameters are ¼-inch larger than the anchor bolt diameters in the base plate.

Provide a circular anchor bolt lock plate securing the anchor bolts at the embedded end with two (2) washers and two (2) nuts. Provide a base plate template matching the bolt circle diameter of the anchor bolt lock plate. Construct plates and templates from ¼-inch minimum thick steel with a minimum width of 4 inches. Hot-dip galvanizing is not required for both plates.

Provide four (4) heavy hex nuts and four (4) flat washers for each anchor bolt. For nuts, use AASHTO M291 grade 2H, DH, or DH3 or equivalent material. For flat washers, use AASHTO M293 or equivalent material. Ensure anchor bolts have required diameters, lengths, and positions, and will develop strengths comparable to their respective poles.

For each pole, provide a grounding lug with a ½-inch minimum thread diameter, coarse thread stud and nut that will accommodate #4 AWG ground wire. Ensure the lug is electrically bonded to the pole and is conveniently located inside the pole at the hand hole.

Provide a removable pole cap with stainless steel attachment screws for the top of each pole. Ensure cap is cast aluminum conforming to Aluminum Association Alloy 356.0F. Furnish cap attached to the pole with a sturdy stainless-steel chain that is long enough to permit cap to hang clear of the pole-top opening when cap is removed.

Where required by the plans, furnish couplings 42 inches above bottom of the pole base for mounting of pedestrian pushbuttons. Provide mounting points consisting of 1½-inch internally threaded half-couplings complying with the NEC, mounted within the poles. Ensure that couplings are essentially flush with the outside surfaces of the poles and are installed before any required hot-dip galvanizing. Provide a threaded plug in each mounting point. Ensure the surface of the plug is essentially flush with the outer end of the mounting point when installed and has a recessed slot that will accommodate a ½ “drive standard socket wrench.

Metal poles may be erected and fully loaded after concrete has attained a minimum allowable compressive strength of 3,000 psi.

Connect poles to grounding electrodes and bond them to the electrical service grounding electrodes.

When field drilling is necessary for wire or cable entrances into the pole, comply with the following requirements:

- Do not drill holes within 2 inches of any welds.
- Do not drill any holes larger than 3 inches in diameter without checking with the ITS & Signals Structure Engineers.
- Avoid drilling multiple holes along the same cross section of tube shafts.

- Install rubber grommets in all field drilled holes that wire, or cable will directly enter unless holes are drilled for installation of weather heads or couplings.
- Treat the inside of the drilled holes and repair all galvanized surfaces in accordance with Section 1076-7 of the latest edition of the *Standard Specification prior to installing grommets, caps, or plugs*.
- Cap or plug any existing field drilled holes that are no longer used with rubber, aluminum, or stainless-steel hole plugs.

When street lighting is installed on metal signal structures, isolate the conductors feeding the luminaires inside the pole shaft using liquid tight flexible metal conduit (Type LFMC), liquid tight flexible nonmetallic conduit (Type LFNC), high density polyethylene conduit (Type HDPE), or approved equivalent. All conductors supplying power for luminaires must run through an external disconnect prior to entrance into the structure. In accordance with the National Electrical Code (NEC) Article 230.2(E), provide identification of the electrical source provider for the luminaire feeder circuit with contact information on a permanent label located in the pole hand hole near the feeder circuit raceway.

Install a 1/4-inch thick plate for a concrete foundation tag to include the following information: concrete grade, depth, diameter, and reinforcement sizes of the installed foundation. Install galvanized wire mesh to cover gap between the base plate and top of foundation for debris and pest control. Refer to standard drawing M7 for further details.

Immediately notify the Engineer of any structural deficiency that becomes apparent in any assembly, or member of any assembly, because of the design requirements imposed by these specifications, the plans, or the typical drawings.

C. Design:

Unless otherwise specified, design all metal pole support structures using the following 1st Edition AASHTO specifications:

- Use 700-Year MRI and 10-Year MRI wind pressure maps developed from 3-second gust speeds, as provided in Section 3.8.
- Ensure metal pole support structures include natural wind gust loading and truck-induced gust loading for fatigue design, as provided in Sections 11.7.1.2 and 11.7.1.3, respectively. Designs need not consider periodic galloping forces.
- Assume 11.2 mph natural wind gust speed in North Carolina. For natural wind fatigue stress calculations, utilize a drag coefficient (C_d) based on the yearly mean wind velocity of 11.2 mph.
- When selecting Fatigue Importance Factors, utilize Fatigue Importance Category II, as provided for in Table 11.6-1, unless otherwise specified.
- Calculate all forces using applicable equations from Section 5. The Maximum allowable force ratio for all metal pole support designs is 0.9.
- Conform to Sections 10.4.2 and 11.8 for deflection requirements. For CCTV and MVD support structures, ensure maximum deflection at top of pole does not exceed 2.0 percent of pole height.
- Assume the combined minimum weight of a messenger cable bundle (including messenger cable, signal cable and detector lead-in cables) is 1.3 lbs/ft. Assume the combined minimum diameter of the cable bundle is 1.3 inches.

- All CCTV and MVD poles shall meet the compact section limits per section 5.7.2 along with Table 5.7.2-1. Minimum thickness of CCTV and MVD pole shafts shall be ¼-inch.
- All CCTV and MVD poles shall use full-penetration groove weld tube-to-transverse plate connection with backing ring. Refer to Metal Pole Standard Drawing Sheet M9 for details. Fillet-welded tube-to-transverse-plate connections are not permitted.

Unless otherwise specified by special loading criteria, the following computed surface area for ice load on signal heads shall be used:

- 3-section, 12-inch, Surface area: 26.0 ft²
- 4-section, 12-inch, Surface area: 32.0 ft²
- 5-section, 12-inch, Surface area: 42.0 ft²

Design a base plate for each pole. The minimum base plate thickness for all poles is determined by the following criteria:

Case 1 Circular or rectangular solid base plate with the upright pole welded to the top surface of base plate with full penetration butt weld, where no stiffeners are provided. A base plate with a small center hole, which is less than 1/3 of the upright diameter, and located concentrically with the upright pole, may be considered as a solid base plate.

The magnitude of bending moment in the base plate, induced by the anchoring force of each anchor bolt is $M = (P \times D_1) / 2$, where

M = bending moment at the critical section of the base plate induced by one (1) anchor bolt

P = anchoring force of each anchor bolt

D_1 = horizontal distance between the anchor bolt center and the outer face of the upright, or the difference between the bolt circle radius and the outside radius of the upright

Locate the critical section at the face of the anchor bolt and perpendicular to the bolt circle radius. The overlapped part of two (2) adjacent critical sections is considered ineffective.

Case 2 Circular or rectangular base plate with the upright pole socketed into and attached to the base plate with two (2) lines of fillet weld, and where no stiffeners are provided, or any base plate with a center hole that is larger in diameter than 1/3 of the upright diameter.

The magnitude of bending moment induced by the anchoring force of each anchor bolt is $M = P \times D_2$,

where P = anchoring force of each anchor bolt

D_2 = horizontal distance between the face of the upright and the face of the anchor bolt nut

Locate the critical section at the face of the anchor bolt top nut and perpendicular to the radius of the bolt circle. The overlapped part of two (2) adjacent critical sections is considered ineffective.

If the base plate thickness calculated for Case 2 is less than Case 1, use the thickness calculated for Case 1.

The following additional requirements apply concerning pole base plates.

- Ensure that whichever case governs as defined above, the anchor bolt diameter is set to match the base plate thickness. If the minimum diameter required for the anchor bolt exceeds

the thickness required for the base plate, set the base plate thickness equal to the required bolt diameter.

- For all metal poles, use a full penetration groove weld with a backing ring to connect the pole upright component to the base. Refer to Metal Pole Standard Drawing Sheet M3 or M4.

The Professional Engineer is wholly responsible for the design of all poles. Review and acceptance of these designs by the Department does not relieve the said Professional Engineer of his or her responsibility.

D. Strain Poles:

Refer to Metal Pole Standard Drawing Sheets M2 and M3 for fabrication details.

Provide two (2) messenger cable (span wire) clamps and associated hardware for attachment of messenger cable. Ensure diameter of the clamp is appropriate to its location on the pole and is appropriately designed for adjustment from 1'-6" below the top, down to 6'-6" below the top of the pole. Do not attach more than one (1) support cable to a messenger cable clamp.

Provide a minimum of three (3) 2-inch holes equipped with an associated coupling and weatherhead on the messenger cable load side of the pole to accommodate passage of signal cables from inside the pole. Provide galvanized threaded plugs for all unused couplings at pole entrance points. Refer to Metal Pole Standard Drawing Sheet M3 for fabrication details.

Provide designs with a 6" x 12" hand hole with reinforcing frame for each pole.

Provide a terminal compartment with cover and screws in each pole encompassing the hand hole and containing a 12-terminal barrier type terminal block. Provide two (2) terminal screws with a removable shorting bar between them for each termination. Furnish terminal compartment covers attached to the pole by a sturdy chain or cable approved by the Engineer. Ensure chain or cable is long enough to permit cover to hang clear of the compartment opening when cover is removed and is strong enough to prevent vandalism. Ensure chain or cable will not interfere with service to cables in the pole base.

Have poles permanently stamped above the hand holes with the identification tag details as shown on Metal Pole Standard Drawing Sheets M2 and M3.

Provide grounding lug(s) in the approximate vicinity of the messenger cable clamp for bonding and grounding messenger cable. Lugs must accept #4 AWG wire to bond messenger cables to the pole in order to provide an effective ground fault circuit path. Refer to Metal Pole Standard Drawing Sheet M6 for construction details.

Install metal poles, hardware, and fittings as shown on the manufacturer's installation drawings. Ensure the installed pole, when fully loaded, is within 1 degree 40 minutes (1°40') of vertical. Install poles with the manufacturer's recommended "rake." Where required, use threaded leveling nuts to establish rake.

5.2. DRILLED PIER FOUNDATIONS FOR METAL POLES

Analysis procedures and formulas shall be based on AASHTO 1st Edition, latest ACI-318 code and the *Drilled Shafts: Construction Procedures and Design Methods* FHWA-NHI-10-016 manual. Design methods based on engineering publications or research papers must have prior approval from NCDOT. The Department reserves the right to accept or reject any method used for the analysis.

Ensure deflection at top of foundation does not exceed 1 inch for worst-case (Service Limit State) lateral load.

Use LPILE Plus V6.0 or later for lateral analysis. Submit inputs, results and corresponding graphs with the design calculations.

Calculate skin friction using the α -method for cohesive soils and the β -method for cohesion-less soils (**Broms method will not be accepted**). Detailed descriptions of the “ α ” and “ β ” methods can be found in *FHWA-NHI-10-016*.

Omit first 2.5 feet for cohesive soils when calculating skin friction.

Assume a hammer efficiency of 0.70 unless value is provided.

All CCTV and MVD pole drilled shafts shall be a minimum of 4'-0" diameter. Refer to Standard Drawing Nos. M7 and M8.

Design custom foundations to carry maximum capacity of each metal pole. For standard case strain poles with custom design, use actual shear, axial and moment reactions from the Standard Strain Pole Foundation Selection Table shown on Standard Drawing No. M8.

When poor soil conditions are encountered, which could create an excessively large foundation design, consideration may be given to allow an exemption to the maximum capacity design. The Contractor must gain approval from the Engineer before reducing a foundation's capacity. On projects where poor soil is known to be present, the Contractor should have foundation designs approved before releasing poles for fabrication.

Have the Contractor notify the Engineer if the proposed foundation is to be installed on a slope other than 8H: 1V or flatter.

A. Description:

Furnish and install foundations for NCDOT metal poles with all necessary hardware in accordance with the plans and specifications.

Metal Pole Standards have been developed and implemented by NCDOT for use at signalized intersections in North Carolina. If the plans call for a standard strain pole, then a standard foundation may be selected from the plans. However, the Contractor is not required to use a standard foundation. If the Contractor chooses to design a non-standard site-specific foundation for a standard strain pole or if the plans call for a non-standard site-specific pole, design the foundation to conform to the applicable provisions in the NCDOT Metal Pole Standard Drawings and Section B4 (Non-Standard Foundation Design) below. If non-standard site-specific foundations are designed for standard QPL approved strain poles, the foundation designer must use the design moment specified by load case on Metal Pole Standard Drawing Sheet M8. Failure to conform to this requirement will be grounds for rejection of the design.

If the Contractor chooses to design a non-standard foundation for a standard strain pole and the soil test results indicate a standard foundation is feasible for the site, the Contractor will be paid the cost of the standard foundation. Any additional cost associated with a non-standard site-specific foundation including additional materials, labor and equipment will be considered incidental to the cost of the standard foundation. All costs for the non-standard foundation design will be considered incidental to the cost of the standard foundation.

B. Soil Test and Foundation Determination:

1. General:

Drilled piers are reinforced concrete sections, cast-in-place against in situ, undisturbed material. Drilled piers are of straight shaft type and vertical.

2. Soil Test:

Perform a soil test at each proposed metal pole location. Complete all required fill placement and excavation at each pole location to finished grade before drilling each boring. Soil tests

performed that are not in compliance with this requirement may be rejected and will not be paid. Drill one boring to a depth of 26 feet within a 25-foot radius of each proposed foundation.

Perform standard penetration tests (SPT) in accordance with ASTM D 1586 at depths of 1, 2.5, 5, 7.5, 10, 15, 20 and 26 feet. Discontinue the boring if one of the following occurs:

- A total of 100 blows have been applied in any two consecutive 6-inch intervals.
- A total of 50 blows have been applied with < 3-inch penetration.

Describe each pole location along the project corridor in a manner that is easily discernible to both the Contractor’s Designer and NCDOT Reviewers. If the pole is at an intersection, label the boring the “Intersection of (Route or SR #), (Street Name) and (Route or SR #), (Street Name), _____ County, Signal or Asset Inventory No. _____”. Label borings with “B- N, S, E, W, NE, NW, SE or SW” corresponding to the quadrant location within the intersection.

If the pole location is located between intersections, provide a coordinate location and offset, or milepost number and offset. Pole numbers should be made available to the Drill Contractor. Include pole numbers in the boring label if they are available. If they are not available, ensure the boring labels can be cross-referenced to corresponding pole numbers. For each boring, submit a legible (hand-written or typed) boring log signed and sealed by a licensed Geologist or Professional Engineer registered in North Carolina. Include on each boring the SPT blow counts and N-values at each depth, depth of the boring, hammer efficiency, depth of water table and a general description of the soil types encountered using the AASHTO Classification System.

Borings that cannot be easily correlated to their specific pole location will be returned to the Contractor for clarification; or if approved by the Engineer, the foundation may be designed using the worst-case soil condition obtained as part of this project.

3. Standard Foundation Determination:

Use the following method for determining the Design N-value:

$$N_{AVG} = \frac{N_{@1'} + N_{@2.5'} + \dots + N_{@Deepest\ Boring\ Depth}}{Total\ Number\ of\ N\ values}$$

$$Y = (N_{@1'})^2 + (N_{@2.5'})^2 + \dots + (N_{@Deepest\ Boring\ Depth})^2$$

$$Z = N_{@1'} + N_{@2.5'} + \dots + N_{@Deepest\ Boring\ Depth}$$

$$N_{STD\ DEV} = \sqrt{\left(\frac{(Total\ Number\ of\ N\ values \times Y) - Z^2}{(Total\ Number\ of\ N\ values) \times (Total\ Number\ of\ N\ values - 1)} \right)}$$

Design N-value equals lesser of the following two conditions:

$$N_{AVG} - (N_{STD\ DEV} \times 0.45)$$

OR

$$Average\ of\ First\ Four\ (4)\ N\ values = \frac{N_{@1'} + N_{@2.5'} + N_{@5'} + N_{@7.5'}}{4}$$

Note: If less than four (4) N-values are obtained because of criteria listed in Section 2 above, use average of N-values collected for second condition. Do not include the N-value at the deepest boring depth for above calculations if the boring is discontinued at or before the required boring depth because of criteria listed in Section 2 above. Use N-value of zero (0) for weight of hammer or weight of rod. If N-value is greater than fifty (50), reduce N-value to fifty (50) for calculations.

If standard NCDOT strain poles are shown on the plans and the Contractor chooses to use standard foundations, determine a drilled pier length, "L," for each signal pole from the Standard Strain Pole Foundations Chart (sheet M8) based on the Design N-value and the predominant soil type. For each standard pole location, submit a completed "Metal Pole Standard Foundation Selection Form" signed by the Contractor's representative. Signature on form is for verification purposes only. Include the Design N-value calculation and resulting drilled pier length, "L," on each form.

If non-standard site-specific poles are shown on the plans, submit completed boring logs collected in accordance with Section 2 (Soil Test) along with pole loading diagrams from the plans to the Contractor-selected pole Fabricator to assist in the pole and foundation design.

If one of the following occurs, the Standard Foundations Chart shown on the plans may not be used and a non-standard foundation may be required. In such case, contact the Engineer.

- The Design N-value is less than four (4).
- The drilled pier length, "L", determined from the Standard Foundations Chart, is greater than the depth of the corresponding boring.

In the case where a standard foundation cannot be used, the Department will be responsible for the additional cost of the non-standard foundation.

Foundation designs are based on level ground around the traffic signal pole. If the slope around the edge of the drilled pier is steeper than 8:1 (H:V) or the proposed foundation will be less than 10 feet from the top of an embankment slope, the Contractor is responsible for providing slope information to the foundation Designer and to the Engineer so it can be considered in the design.

The "Metal Pole Standard Foundation Selection Form" may be found at:

<https://connect.ncdot.gov/resources/safety/Pages/ITS-Design-Resources.aspx>

If assistance is needed, contact the Engineer.

4. Non-Standard Foundation Design:

Design non-standard foundations based upon site-specific soil test information collected in accordance with Section 2 (Soil Test). Design drilled piers for side resistance in accordance with Section 10.8 of the *2014 AASHTO LRFD Bridge Design Specifications, 7th Edition*. Use computer software LPILE version-6.0 or later manufactured by Ensoft, Inc. to analyze drilled piers. Use computer software gINT V8i or later manufactured by Bentley Systems, Inc. with the current NCDOT gINT library and data template to produce SPT boring logs. Provide a drilled pier foundation for each pole with a length and diameter resulting in horizontal lateral movement less than 1 inch at top of the pier, and horizontal rotational movement less than 1 inch at the edge of pier. Contact the Engineer for pole loading diagrams of standard poles used for non-standard foundation designs. Submit non-standard foundation designs including drawings, calculations, and soil boring logs to the Engineer for review and approval before construction.

C. Drilled Pier Construction:

Construct drilled pier foundation and Install anchor rod assemblies in accordance with the *Foundations and Anchor Rod Assemblies for Metal Poles* Standard Special Provision SP09-R005 located at:

<https://connect.ncdot.gov/resources/Specifications/Pages/2024-Specifications-and-Special-Provisions.aspx>

5.3. METAL POLE REMOVALS**A. Description:**

Remove and dispose of existing metal support poles, and remove and dispose of existing foundations, associated anchor bolts, electrical wires and connections.

B. Construction Methods:**5. Foundations:**

Remove and promptly dispose of the metal support pole foundations including reinforcing steel, electrical wires, and anchor bolts to a minimum depth of 2 feet below the finished ground elevation. At the Contractor's option, remove the complete foundation.

6. Metal Poles:

Consult Division Traffic Services regarding ownership of poles. If the Division chooses to maintain these structures in their inventory for future use, permanently mark the pole with the signal inventory number, asset inventory number or some identifying information that identifies where the pole came from

Remove the metal support poles, and promptly transport the metal support poles from the project. Use methods to remove the metal support poles and attached equipment that will not result in damage to other portions of the project or facility. Repair damages that are a result of the Contractor's actions at no additional cost to the Department.

Transport and properly dispose of the materials.

Backfill and compact disturbed areas to match the finished ground elevation. Seed unpaved areas.

Use methods to remove the foundations that will not result in damage to other portions of the project or facility. Repair damages that are a result of the Contractor's actions at no cost to the Department.

5.4. POLE NUMBERING SYSTEM**A. New Poles**

Attach an identification tag to each pole shaft section as shown on Metal Pole Standard Sheet M2 "Typical Fabrication Details for All Metal Poles."

5.5. MEASUREMENT AND PAYMENT

Actual number of metal strain signal poles (without regard to height or load capacity) furnished, installed and accepted.

Actual number of designs for metal strain poles furnished and accepted.

Actual number of metal signal pole foundations removed and disposed.

Actual number of metal signal poles removed and disposed.

Actual number of soil tests with SPT borings drilled furnished and accepted.

Actual volume of concrete poured in cubic yards of drilled pier foundation furnished, installed and accepted.

No measurement will be made for foundation designs prepared with metal pole designs, as these will be considered incidental to designing Traffic Signal , CCTV or MVD support structures.

Payment will be made under:

Metal Strain Signal Pole	Each
Metal Pole Foundation Removal	Each
Metal Pole Removal.....	Each
Soil Test	Each
Drilled Pier Foundation.....	Cubic Yard

6. ETHERNET EDGE SWITCH

Furnish and install a managed Ethernet edge switch as specified below that is fully compatible, interoperable, and completely interchangeable and functional within the existing City, Division, or Statewide traffic signal system communications network.

6.1. DESCRIPTION

A. Ethernet Edge Switch:

Furnish and install a hardened, field Ethernet edge switch (hereafter “edge switch”) for the traffic signal controller or ITS device as specified below. Ensure that the edge switch provides wire-speed, fast Ethernet connectivity at transmission rates of 1000 megabits per second from each remote traffic signal controller or ITS device location to the routing switches.

Contact the City or NCDIT to arrange for the programming of the new Field Ethernet Switches with the necessary network configuration data, including but not limited to, the IP Address, Default Gateway, Subnet Mask and VLAN ID information. Provide a minimum ten (10) working days notice to allow the City or NCDIT to program the new devices.

B. Network Management:

Ensure that the edge switch is fully compatible with the existing City, Division, or Statewide Network Management Software.

6.2. MATERIALS

A. General:

Ensure that the edge switch is fully compatible and interoperable with the trunk Ethernet network interface and that the edge switch supports half and full duplex Ethernet communications.

Furnish an edge switch that provide 99.999% error-free operation, and that complies with the Electronic Industries Alliance (EIA) Ethernet data communication requirements using single-mode fiber-optic transmission medium and copper transmission medium. Ensure that the edge switch has a minimum mean time between failures (MTBF) of 10 years, or 87,600 hours, as calculated using the Bellcore/Telcordia SR-332 standard for reliability prediction.

B. Compatibility Acceptance

The Engineer has the authority to require the Contractor to submit a sample Field Ethernet Switch and SFP along with all supporting documentation, software and testing procedures to allow a compatibility acceptance test be performed prior to approving the proposed Field Ethernet Switch and Field Ethernet Transceiver for deployment. **The Compatibility Acceptance testing will ensure that the proposed device is 100% compatible and interoperable with the existing City, Division, or Statewide Signal System network, monitoring software and Traffic Operations Center network hardware.** Allow fifteen (15) working days for the Compatibility Acceptance Testing to be performed

C. Standards:

Ensure that the edge switch complies with all applicable IEEE networking standards for Ethernet communications, including but not limited to:

- IEEE 802.1D standard for media access control (MAC) bridges used with the Spanning Tree Protocol (STP);
- IEEE 802.1Q standard for port-based virtual local area networks (VLANs);
- IEEE 802.1P standard for Quality of Service (QoS);
- IEEE 802.1w standard for MAC bridges used with the Rapid Spanning Tree Protocol (RSTP);
- IEEE 802.1s standard for MAC bridges used with the Multiple Spanning Tree Protocol;
- IEEE 802.1x standard for port based network access control, including RADIUS;
- IEEE 802.3 standard for local area network (LAN) and metropolitan area network (MAN) access and physical layer specifications;
- IEEE 802.3u supplement standard regarding 100 Base TX/100 Base FX;
- IEEE 802.3x standard regarding flow control with full duplex operation; and
- IFC 2236 regarding IGMP v2 compliance.
- IEEE 802.1AB Link Layer Discovery Protocol (LLDP)
- IEEE 802.3ad Ethernet Link Aggregation
- IEEE 802.3i for 10BASE-T (10 Mbit/s over Fiber-Optic)
- IEEE 802.3ab for 1000BASE-T (1Gbit/s over Ethernet)
- IEEE 802.3z for 1000BASE-X (1 Gbit/s Ethernet over Fiber-Optic)

D. Functional:

Ensure that the edge switch supports all Layer 2 management features and certain Layer 3 features related to multicast data transmission and routing. These features shall include, but not be limited to:

- An STP healing/convergence rate that meets or exceeds specifications published in the IEEE 802.1D standard.
- An RSTP healing/convergence rate that meets or exceeds specifications published in the IEEE 802.1w standard.
- An Ethernet edge switch that is a port-based VLAN and supports VLAN tagging that meets or exceeds specifications as published in the IEEE 802.1Q standard, and has a minimum 4-kilobit VLAN address table (254 simultaneous).
- A forwarding/filtering rate that is a minimum of 14,880 packets per second for 10 megabits per second and 148,800 packets per second for 100 megabits per second.
- A minimum 4-kilobit MAC address table.

- Support of Traffic Class Expediting and Dynamic Multicast Filtering.
- Support of, at a minimum, snooping of Version 2 & 3 of the Internet Group Management Protocol (IGMP).
- Support of remote and local setup and management via telnet or secure Web-based GUI and command line interfaces.
- Support of the Simple Network Management Protocol version 3 (SNMPv3). Verify that the Ethernet edge switch can be accessed using the resident EIA-232 management port, a telecommunication network, or the Trivial File Transfer Protocol (TFTP).
- Port security through controlling access by the users. Ensure that the Ethernet edge switch has the capability to generate an alarm and shut down ports when an unauthorized user accesses the network.
- Support of remote monitoring (RMON-1 & RMON-2) of the Ethernet agent.
- Support of the TFTP and SNMP. Ensure that the Ethernet edge switch supports port mirroring for troubleshooting purposes when combined with a network analyzer.

E. Physical Features:

Ports: Provide 10/100/1000 Mbps auto-negotiating ports (RJ-45) copper Fast Ethernet ports for all edge switches. Provide auto-negotiation circuitry that will automatically negotiate the highest possible data rate and duplex operation possible with attached devices supporting the IEEE 802.3 Clause 28 auto-negotiation standard.

Optical Ports: Ensure that all fiber-optic link ports operate at 1310 or 1550 nanometers in single mode. Provide Type LC connectors for the optical ports, as specified in the Plans or by the Engineer. Do not use mechanical transfer registered jack (MTRJ) type connectors.

Provide an edge switch having a minimum of two optical 100/1000 Base X ports capable of transmitting data at 100/1000 megabits per second. Ensure that each optical port consists of a pair of fibers; one fiber will transmit (TX) data and one fiber will receive (RX) data. Ensure that the optical ports have an optical power budget of at least 15 dB. Provide small form-factor pluggable modules (SFPs) with a maximum range that meets or exceeds the distance requirement as indicated on the Plans.

Copper Ports: Provide an edge switch that includes a minimum of four copper ports. Provide Type RJ-45 copper ports and that auto-negotiate speed (i.e., 10/100/1000 Base) and duplex (i.e., full or half). Ensure that all 10/100/1000 Base TX ports meet the specifications detailed in this section and are compliant with the IEEE 802.3 standard pinouts. Ensure that all Category 6 unshielded twisted pair/shielded twisted pair network cables are compliant with the EIA/TIA-568-B standard.

Port Security: Ensure that the edge switch supports/complies with the following (remotely) minimum requirements:

- Ability to configure static MAC addresses access;
- Ability to disable automatic address learning per ports; know hereafter as Secure Port. Secure Ports only forward; and
- Trap and alarm upon any unauthorized MAC address and shutdown for programmable duration. Port shutdown requires administrator to manually reset the port before communications are allowed.

F. Management Capabilities:

Ensure that the edge switch supports all Layer 2 management features and certain Layer 3 features related to multicast data transmission and routing. These features shall include, but not be limited to:

- An STP healing/convergence rate that meets or exceeds specifications published in the IEEE 802.1 D standards;
- An RSTP healing/convergence rate that meets or exceeds specifications published in the IEEE 802.1w standard;
- An Ethernet edge switch that is a port-based VLAN and supports VLAN tagging that meets or exceeds specifications as published in the IEEE 802.1Q standard, and has a minimum 4-kilobit VLAN address table (254 simultaneous);
- A forwarding/filtering rate that is a minimum of 14,880 packets per second for 10 megabits per second, 148,800 packets per second for 100 megabits per second and 1,488,000 packets per second for 1000 megabits per second;
- A minimum 4-kilobit MAC address table;
- Support of Traffic Class Expediting and Dynamic Multicast Filtering.
- Support of, at a minimum, snooping of Version 2 & 3 of the Internet Group Management Protocol (IGMP);
- Support of remote and local setup and management via telnet or secure Web-based GUI and command line interfaces; and
- Support of the Simple Network Management Protocol (SNMP). Verify that the Ethernet edge switch can be accessed using the resident EIA-232 management port, a telecommunication network, or the Trivial File Transfer Protocol (TFTP).

Network Capabilities: Provide an edge switch that supports/complies with the following minimum requirements:

- Provide full implementation of IGMPv2 snooping (RFC 2236);
- Provide full implementation of SNMPv1, SNMPv2c, and/or SNMPv3;
- Provide support for the following RMON–I groups, at a minimum:
 - Part 1: Statistics
 - Part 2: History
 - Part 3: Alarm
 - Part 9: Event
- Provide support for the following RMON–2 groups, at a minimum:
 - Part 13: Address Map
 - Part 16: Layer Host
 - Part 17: Layer Matrix
 - Part 18: User History
- Capable of mirroring any port to any other port within the switch;
- Meet the IEEE 802.1Q (VLAN) standard per port for up to four VLANs;
- Meet the IEEE 802.3ad (Port Trunking) standard for a minimum of two groups of four ports;
- Password manageable;
- Telnet/CLI;
- HTTP (Embedded Web Server) with Secure Sockets Layer (SSL); and
- Full implementation of RFC 783 (TFTP) to allow remote firmware upgrades.

Network Security: Provide an edge switch that supports/complies with the following (remotely) minimum network security requirements:

- Multi-level user passwords;
- RADIUS centralized password management (IEEE 802.1X);
- SNMPv3 encrypted authentication and access security;
- Port security through controlling access by the users: ensure that the Ethernet edge switch has the capability to generate an alarm and shut down ports when an unauthorized user accesses the network;
- Support of remote monitoring (RMON-1&2) of the Ethernet agent; and
- Support of the TFTP and SNTP. Ensure that the Ethernet edge switch supports port mirroring for troubleshooting purposes when combined with a network analyzer.

G. Electrical Specifications:

Ensure that the edge switch operates and power is supplied with 115 volts of alternating current (VAC). Ensure that the edge switch has a minimum operating input of 110 VAC and a maximum operating input of 130 VAC. Ensure that if the device requires operating voltages other than 120 VAC, supply the required voltage converter. Ensure that the maximum power consumption does not exceed 50 watts. Ensure that the edge switch has diagnostic light emitting diodes (LEDs), including link, TX, RX, speed (for Category 6 ports only), and power LEDs.

H. Environmental Specifications:

Ensure that the edge switch performs all of the required functions during and after being subjected to an ambient operating temperature range of -30 degrees to 165 degrees Fahrenheit as defined in the environmental requirements section of the NEMA TS 2 standard, with a noncondensing humidity of 0 to 95%.

Provide certification that the device has successfully completed environmental testing as defined in the environmental requirements section of the NEMA TS 2 standard. Provide certification that the device meets the vibration and shock resistance requirements of Sections 2.1.9 and 2.1.10, respectively, of the NEMA TS 2 standard. Ensure that the edge switch is protected from rain, dust, corrosive elements, and typical conditions found in a roadside environment.

The edge switch shall meet or exceed the following environmental standards:

- IEEE 1613 (electric utility substations)
- IEC 61850-3 (electric utility substations)
- IEEE 61800-3 (variable speed drive systems)
- IEC 61000-6-2 (generic industrial)
- EMF – FCC Part 15 CISPR (EN5502) Class A

I. Ethernet Patch Cable:

Furnish a factory pre-terminated/pre-connectorized Ethernet patch cable with each edge switch. Furnish Ethernet patch cables meeting the following physical requirements:

- Five (5)-foot length
- Category 6 or better
- Factory-installed RJ-45 connectors on both ends
- Molded anti-snap hoods over connectors
- Gold plated connectors

- Copper-clad aluminum is **NOT** allowed.

Furnish Fast Ethernet patch cords meeting the following minimum performance requirements:

- TIA/EIA-568-B-5, Additional Transmission Performance Specifications for 4-pair 100 Ω Enhanced Category 6 Cabling
- Frequency Range: 1-100 MHz
- Near-End Crosstalk (NEXT): 30.1 dB
- Power-sum NEXT: 27.1 dB
- Attenuation to Crosstalk Ratio (ACR): 6.1 dB
- Power-sum ACR: 3.1 dB
- Return Loss: 10dB
- Propagation Delay: 548 nsec

6.3. CONSTRUCTION METHODS

A. General:

Ensure that the edge switch is UL listed.

Verify that network/field/data patch cords meet all ANSI/EIA/TIA requirements for Category 6 four-pair unshielded twisted pair cabling with stranded conductors and RJ45 connectors.

Contact the City, Division, or NCDIT a minimum of 10 working days prior to installation to allow for the programming of the edge switch.

B. Edge Switch:

Mount the edge switch inside each field cabinet by securely fastening the edge switch to the upper end of the right rear vertical rail of the equipment rack using manufacturer-recommended or Engineer-approved attachment methods, attachment hardware and fasteners.

Ensure that the edge switch is mounted securely in the cabinet and is fully accessible by field technicians without blocking access to other equipment. Verify that fiber-optic jumpers consist of a length of cable that has connectors on both ends, primarily used for interconnecting termination or patching facilities and/or equipment.

6.4. MEASUREMENT AND PAYMENT

Ethernet edge switch will be measured and paid as the actual number of Ethernet edge switches furnished, installed, and accepted.

No separate measurement will be made for Ethernet patch cable, small form factor pluggable modules (SFPs), power cord, mounting hardware, nuts, bolts, brackets, or edge switch programming as these will be considered incidental to furnishing and installing the edge switch.

Payment will be made under:

Ethernet Edge Switch.....Each

Project U-3609B

ST-1

Wayne County

Project Special Provisions

Structures

Table of Contents



Signed by: *Josh Kennedy* 11/3/2025
674425111E1B465...

Page No.

1. Falsework and Formwork	(11-30-23)	ST-2
2. Submittal of Working Drawings	(1-31-25)	ST-8
3. Crane Safety	(11-30-23)	ST-14
4. Grout for Structures	(12-1-17)	ST-15

Project U-3609B

ST-2

Wayne County

FALSEWORK AND FORMWORK**(11-30-23)****GENERAL**

Use this Special Provision as a guide to develop temporary works submittals required by the *Standard Specifications* or other provisions; no additional submittals are required herein. Such temporary works include, but are not limited to, falsework and formwork.

Falsework is any temporary construction used to support the permanent structure until it becomes self-supporting. Formwork is the temporary structure or mold used to retain plastic or fluid concrete in its designated shape until it hardens. Access scaffolding is a temporary structure that functions as a work platform that supports construction personnel, materials, and tools, but is not intended to support the structure. Scaffolding systems that are used to temporarily support permanent structures (as opposed to functioning as work platforms) are considered to be falsework under the definitions given. Shoring is a component of falsework such as horizontal, vertical, or inclined support members. Where the term "temporary works" is used, it includes all of the temporary facilities used in bridge construction that do not become part of the permanent structure.

Design and construct safe and adequate temporary works that will support all loads imposed and provide the necessary rigidity to achieve the lines and grades shown on the plans in the final structure.

MATERIALS

Select materials suitable for temporary works; however, select materials that also ensure the safety and quality required by the design assumptions. The Engineer has authority to reject material on the basis of its condition, inappropriate use, safety, or nonconformance with the plans. Clearly identify allowable loads or stresses for all materials or manufactured devices on the plans. Revise the plan and notify the Engineer if any change to materials or material strengths is required.

DESIGN REQUIREMENTS**(A) Working Drawings**

Provide working drawings for items as specified in the contract, or as required by the Engineer, with design calculations and supporting data in sufficient detail to permit a structural and safety review of the proposed design of the temporary work.

On the drawings, show all information necessary to allow the design of any component to be checked independently as determined by the Engineer.

When concrete placement is involved, include data such as the drawings of proposed sequence, rate of placement, direction of placement, and location of all construction joints.

When required, have the drawings and calculations prepared under the guidance of, and sealed by, a North Carolina Registered Professional Engineer who is knowledgeable in temporary works design.

If requested by the Engineer, submit with the working drawings manufacturer's catalog data listing the weight of all construction equipment that will be supported on the temporary work.

Show anticipated total settlements and/or deflections of falsework and forms on the working drawings. Include falsework footing settlements, joint take-up, and deflection of beams or girders.

As an option for the Contractor, overhang falsework hangers may be uniformly spaced, at a maximum of 36 inches, provided the following conditions are met:

Member Type (PCG)	Member Depth, (inches)	Max. Overhang Width, (inches)	Max. Slab Edge Thickness, (inches)	Max. Screenshot Wheel Weight, (lbs.)	Bracket Min. Vertical Leg Extension, (inches)
II	36	39	14	2000	26
III	45	42	14	2000	35
IV	54	45	14	2000	44
MBT	63	51	12	2000	50
MBT	72	55	12	1700	48

Overhang width is measured from the centerline of the girder to the edge of the deck slab. For Type II, III & IV prestressed concrete girders (PCG), 45-degree cast-in-place half hangers and rods must have a minimum safe working load of 6,000 lbs.

For MBT prestressed concrete girders, 45-degree angle holes for falsework hanger rods shall be cast through the girder top flange and located, measuring along the top of the member, 1'-2 1/2" from the edge of the top flange. Hanger hardware and rods must have a minimum safe working load of 6,000 lbs.

For link slabs, the top of girders directly beneath the link slab shall be free of overhang falsework attachments or other hardware. Submit calculations and working drawings for overhang falsework in the link slab region.

The overhang bracket provided for the diagonal leg shall have a minimum safe working load of 3,750 lbs. The vertical leg of the bracket shall extend to the point that the heel bears on the girder bottom flange, no closer than 4 inches from the bottom of the member. However, for 72-inch members, the heel of the bracket shall bear on the web, near the bottom flange transition.

Provide adequate overhang falsework and determine the appropriate adjustments for deck geometry, equipment, casting procedures and casting conditions.

If the optional overhang falsework spacing is used, indicate this on the falsework submittal and advise the girder producer of the proposed details. Failure to notify the Engineer of hanger type and hanger spacing on prestressed concrete girder casting drawings may delay the approval of those drawings.

Falsework hangers that support concentrated loads and are installed at the edge of thin top flange concrete girders (such as bulb tee girders) shall be spaced so as not to exceed 75% of the manufacturer’s stated safe working load. Use of dual leg hangers (such as Meadow Burke HF-42 and HF-43) are not allowed on concrete girders with thin top flanges. Design the falsework and forms supporting deck slabs and overhangs on girder bridges so that there will be no differential settlement between the girders and the deck forms during placement of deck concrete.

When staged construction of the bridge deck is required, detail falsework and forms for screed and fluid concrete loads to be independent of any previous deck pour components when the mid-span girder deflection due to deck weight is greater than $\frac{3}{4}$ ".

Note on the working drawings any anchorages, connectors, inserts, steel sleeves or other such devices used as part of the falsework or formwork that remains in the permanent structure. If the plan notes indicate that the structure contains the necessary corrosion protection required for a Corrosive Site, epoxy coat, galvanize or metalize these devices. Electroplating will not be allowed. Any coating required by the Engineer will be considered incidental to the various pay items requiring temporary works.

Design falsework and formwork requiring submittals in accordance with the current edition of AASHTO *Guide Design Specifications for Bridge Temporary Works* except as noted herein.

(1) Wind Loads

Table 2.2 of Article 2.2.5.1 is modified to include wind velocities up to 110 mph. In addition, Table 2.2A is included to provide the maximum wind speeds by county in North Carolina.

Table 2.2 - Wind Pressure Values

Height Zone feet above ground	Pressure, lb/ft ² for Indicated Wind Velocity, mph				
	70	80	90	100	110
0 to 30	15	20	25	30	35
30 to 50	20	25	30	35	40
50 to 100	25	30	35	40	45
over 100	30	35	40	45	50

(2) Time of Removal

The following requirements replace those of Article 3.4.8.2.

Do not remove forms until the concrete has attained strengths required in Article 420-16 of the *Standard Specifications* and these Special Provisions.

Do not remove forms until the concrete has sufficient strength to prevent surface damage.

Table 2.2A - Steady State Maximum Wind Speeds by Counties in North Carolina

COUNTY	25 YR (mph)	COUNTY	25 YR (mph)	COUNTY	25 YR (mph)
Alamance	70	Franklin	70	Pamlico	100
Alexander	70	Gaston	70	Pasquotank	100
Alleghany	70	Gates	90	Pender	100
Anson	70	Graham	80	Perquimans	100
Ashe	70	Granville	70	Person	70
Avery	70	Greene	80	Pitt	90
Beaufort	100	Guilford	70	Polk	80
Bertie	90	Halifax	80	Randolph	70
Bladen	90	Harnett	70	Richmond	70
Brunswick	100	Haywood	80	Robeson	80
Buncombe	80	Henderson	80	Rockingham	70
Burke	70	Hertford	90	Rowan	70
Cabarrus	70	Hoke	70	Rutherford	70
Caldwell	70	Hyde	110	Sampson	90
Camden	100	Iredell	70	Scotland	70
Carteret	110	Jackson	80	Stanley	70
Caswell	70	Johnston	80	Stokes	70
Catawba	70	Jones	100	Surry	70
Cherokee	80	Lee	70	Swain	80
Chatham	70	Lenoir	90	Transylvania	80
Chowan	90	Lincoln	70	Tyrell	100
Clay	80	Macon	80	Union	70
Cleveland	70	Madison	80	Vance	70
Columbus	90	Martin	90	Wake	70
Craven	100	McDowell	70	Warren	70
Cumberland	80	Mecklenburg	70	Washington	100
Currituck	100	Mitchell	70	Watauga	70
Dare	110	Montgomery	70	Wayne	80
Davidson	70	Moore	70	Wilkes	70
Davie	70	Nash	80	Wilson	80
Duplin	90	New Hanover	100	Yadkin	70
Durham	70	Northampton	80	Yancey	70
Edgecombe	80	Onslow	100		

Forsyth	70	Orange	70		
---------	----	--------	----	--	--

(B) Review and Approval

The Engineer is responsible for the review and approval of temporary works' drawings.

Submit the working drawings sufficiently in advance of proposed use to allow for their review, revision (if needed), and approval without delay to the work.

The time period for review of the working drawings does not begin until complete drawings and design calculations, when required, are received by the Engineer.

Do not start construction of any temporary work for which working drawings are required until the drawings have been approved. Such approval does not relieve the Contractor of the responsibility for the accuracy and adequacy of the working drawings.

CONSTRUCTION REQUIREMENTS

All requirements of Section 420 of the *Standard Specifications* apply.

Construct temporary works in conformance with the approved working drawings. Ensure that the quality of materials and workmanship employed is consistent with that assumed in the design of the temporary works. Do not weld falsework members to any portion of the permanent structure unless approved. Show any welding to the permanent structure on the approved construction drawings.

Provide tell-tales attached to the forms and extending to the ground, or other means, for accurate measurement of falsework settlement. Make sure that the anticipated compressive settlement and/or deflection of falsework does not exceed 1 inch. For cast-in-place concrete structures, make sure that the calculated deflection of falsework flexural members does not exceed 1/240 of their span regardless of whether or not the deflection is compensated by camber strips.

(A) Maintenance and Inspection

Inspect and maintain the temporary work in an acceptable condition throughout the period of its use. Certify that the manufactured devices have been maintained in a condition to allow them to safely carry their rated loads. Clearly mark each piece so that its capacity can be readily determined at the job site.

Perform an in-depth inspection of an applicable portion(s) of the temporary works, in the presence of the Engineer, not more than 24 hours prior to the beginning of each concrete placement. Inspect other temporary works at least once a month to ensure that they are functioning properly. Have a North Carolina Registered Professional Engineer inspect the cofferdams, shoring, sheathing, support of excavation structures, and support systems for load tests prior to loading.

Project U-3609B

ST-7

Wayne County

(B) Foundations

Determine the safe bearing capacity of the foundation material on which the supports for temporary works rest. If required by the Engineer, conduct load tests to verify proposed bearing capacity values that are marginal or in other high-risk situations.

The use of the foundation support values shown on the contract plans of the permanent structure is permitted if the foundations are on the same level and on the same soil as those of the permanent structure.

Allow for adequate site drainage or soil protection to prevent soil saturation and washout of the soil supporting the temporary works supports.

If piles are used, the estimation of capacities and later confirmation during construction using standard procedures based on the driving characteristics of the pile is permitted. If preferred, use load tests to confirm the estimated capacities; or, if required by the Engineer conduct load tests to verify bearing capacity values that are marginal or in other high risk situations.

The Engineer reviews and approves the proposed pile and soil bearing capacities.

REMOVAL

Unless otherwise permitted, remove and keep all temporary works upon completion of the work. Do not disturb or otherwise damage the finished work.

Remove temporary works in conformance with the contract documents. Remove them in such a manner as to permit the structure to uniformly and gradually take the stresses due to its own weight.

MEASUREMENT AND PAYMENT

Unless otherwise specified, *Falsework and Formwork* will not be directly measured.

Payment at the contract unit prices for the various pay items requiring temporary works will be full compensation for the above falsework and formwork.

Project U-3609B

ST-8

Wayne County

SUBMITTAL OF WORKING DRAWINGS**(1-31-25)****GENERAL**

Submit working drawings in accordance with Article 105-2 of the *Standard Specifications* and this Special Provision. For this Special Provision, “submittals” refers to only those listed in this Special Provision. The list of submittals contained herein does not represent a list of required submittals for the project. Submittals are only necessary for those items as required by the contract. Make submittals that are not specifically noted in this provision directly to the Engineer. Either the Structures Management Unit or the Geotechnical Engineering Unit or both units will jointly review submittals.

If a submittal contains variations from plan details or specifications or significantly affects project cost, field construction or operations, discuss the submittal with and submit all copies to the Engineer. State the reason for the proposed variation in the submittal. To minimize review time, make sure all submittals are complete when initially submitted. Provide a contact name and information with each submittal. Direct any questions regarding submittal requirements to the Engineer, Structures Management Unit contacts or the Geotechnical Engineering Unit contacts noted below.

To facilitate in-plant inspection by NCDOT and approval of working drawings, provide the name, address and telephone number of the facility where fabrication will actually be done if different than shown on the title block of the submitted working drawings. This includes, but is not limited to, precast concrete items, prestressed concrete items and fabricated steel or aluminum items.

ADDRESSES AND CONTACTS

For submittals to the Structures Management Unit, use the following addresses:

Via Email: SMU-wdr@ncdot.gov (do not cc SMU Working Drawings staff)

Via US mail:

Mr. D. N. Snoke, P. E.
State Structures Engineer
North Carolina Department
of Transportation
Structures Management Unit
1581 Mail Service Center
Raleigh, NC 27699-1581

Attention: Mr. J. L. Bolden, P. E.

Via other delivery service:

Mr. D. N. Snoke, P. E.
State Structures Engineer
North Carolina Department
of Transportation
Structures Management Unit
1000 Birch Ridge Drive
Raleigh, NC 27610

Attention: Mr. J. L. Bolden, P. E.

For submittals to the Geotechnical Engineering Unit, use the following addresses:

For projects in Divisions 1-7 (Eastern Regional Office):

Via Email: EastGeotechnicalSubmittal@ncdot.gov

Project U-3609B

ST-9

Wayne County

Via US mail:

Mr. Thomas Santee, P. E.
Assistant State Geotechnical
Engineer – Eastern Region
North Carolina Department
of Transportation
Geotechnical Engineering Unit
Eastern Regional Office
1570 Mail Service Center
Raleigh, NC 27699-1570

Via other delivery service:

Mr. Thomas Santee, P. E.
Assistant State Geotechnical
Engineer – Eastern Region
North Carolina Department
of Transportation
Geotechnical Engineering Unit
Eastern Regional Office
3301 Jones Sausage Road, Suite 100
Garner, NC 27529

For projects in Divisions 8-14 (Western Regional Office):

Via Email: WestGeotechnicalSubmittal@ncdot.gov

Via US mail or other delivery service:

Mr. Eric Williams, P. E.
Assistant State Geotechnical
Engineer – Western Region
North Carolina Department
of Transportation
Geotechnical Engineering Unit
Western Regional Office
5253 Z Max Boulevard
Harrisburg, NC 28075

The status of the review of structure-related submittals sent to the Structures Management Unit can be viewed from the Unit’s website, via the “[Drawing Submittal Status](#)” link. The status of the review of geotechnical-related submittals sent to the Geotechnical Engineering Unit can be viewed from the Unit’s website, via the “[Geotechnical Construction Submittals](#)” link.

Direct any questions concerning submittal review status, review comments or drawing markups to the following contacts:

Primary Structures Contact: James Bolden (919) 707 – 6408
jlbolden@ncdot.gov

Secondary Structures Contacts: Madonna Rorie (919) 707 – 6508
mlrorie@ncdot.gov

Eastern Regional Geotechnical Contact (Divisions 1-7):

Thomas Santee (984) 920-8901

Project U-3609B

ST-10

Wayne County

EastGeotechnicalSubmittal@ncdot.gov

Western Regional Geotechnical Contact (Divisions 8-14):

Eric Williams (980)258-6400

WestGeotechnicalSubmittal@ncdot.gov

SUBMITTAL COPIES

Furnish one complete copy of each submittal, including all attachments, to the Engineer. At the same time, submit a copy of the same complete submittal directly to the Structures Management Unit and/or the Geotechnical Engineering Unit as specified in the tables below.

The first table below covers “Structure Submittals.” The Engineer will receive review comments and drawing markups for these submittals from the Structures Management Unit. The second table in this section covers “Geotechnical Submittals.” The Engineer will receive review comments and drawing markups for these submittals from the Geotechnical Engineering Unit.

Unless otherwise required, submit one set of supporting calculations to either the Structures Management Unit or the Geotechnical Engineering Unit unless both units require submittal copies in which case submit a set of supporting calculations to each unit. Provide additional copies of any submittal as directed.

STRUCTURE SUBMITTALS

Submittal	Submittal Required by Structures Management Unit?	Submittal Required by Geotechnical Engineering Unit?	Contract Reference Requiring Submittal ¹
Arch Culvert Falsework	Y	N	Plan Note, SN Sheet & “Falsework and Formwork”
Box Culvert Falsework ⁷	Y	N	Plan Note, SN Sheet & “Falsework and Formwork”
Cofferdams	Y	Y	Article 410-4
Foam Joint Seals ⁶	Y	N	“Foam Joint Seals”
Expansion Joint Seals (hold down plate type with base angle)	Y	N	“Expansion Joint Seals”

Project U-3609B

ST-11

Wayne County

Expansion Joint Seals (modular)	Y	N	“Modular Expansion Joint Seals”
Expansion Joint Seals (strip seals)	Y	N	“Strip Seal Expansion Joints”
Falsework & Forms ² (substructure)	Y	N	Article 420-3 & “Falsework and Formwork”
Falsework & Forms (superstructure)	Y	N	Article 420-3 & “Falsework and Formwork”
Girder Erection over Railroad	Y	N	Railroad Provisions
Maintenance and Protection of Traffic Beneath Proposed Structure	Y	N	“Maintenance and Protection of Traffic Beneath Proposed Structure at Station ____”
Metal Bridge Railing	Y	N	Plan Note
Metal Stay-in-Place Forms	Y	N	Article 420-3
Metalwork for Elastomeric Bearings ^{4,5}	Y	N	Article 1072-8
Miscellaneous Metalwork ^{4,5}	Y	N	Article 1072-8
Disc Bearings ⁴	Y	N	“Disc Bearings”
Overhead and Digital Message Signs (DMS) (metalwork and foundations)	Y	N	Applicable Provisions
Placement of Equipment on Structures (cranes, etc.)	Y	N	Article 420-20
Prestressed Concrete Box Beam (detensioning sequences) ³	Y	N	Article 1078-11
Precast Concrete Box Culverts	Y	N	“Optional Precast Reinforced Concrete Box Culvert at Station ____”
Prestressed Concrete Cored Slab (detensioning sequences) ³	Y	N	Article 1078-11
Prestressed Concrete Deck Panels	Y	N	Article 420-3

Project U-3609B

ST-12

Wayne County

Prestressed Concrete Girder (strand elongation and detensioning sequences)	Y	N	Articles 1078-8 and 1078-11
Removal of Existing Structure over Railroad	Y	N	Railroad Provisions
<hr/>			
Revised Bridge Deck Plans (adaptation to prestressed deck panels)	Y	N	Article 420-3
Revised Bridge Deck Plans (adaptation to modular expansion joint seals)	Y	N	“Modular Expansion Joint Seals”
Sound Barrier Wall (precast items)	Y	N	Article 1077-2 & “Sound Barrier Wall”
Sound Barrier Wall Steel Fabrication Plans ⁵	Y	N	Article 1072-8 & “Sound Barrier Wall”
Structural Steel ⁴	Y	N	Article 1072-8
Temporary Detour Structures	Y	Y	Article 400-3 & “Construction, Maintenance and Removal of Temporary Structure at Station _____”
TFE Expansion Bearings ⁴	Y	N	Article 1072-8

FOOTNOTES

1. References are provided to help locate the part of the contract where the submittals are required. References in quotes refer to the provision by that name. Articles refer to the *Standard Specifications*.
2. Submittals for these items are necessary only when required by a note on plans.
3. Submittals for these items may not be required. A list of pre-approved sequences is available from the producer or the Materials & Tests Unit.
4. The fabricator may submit these items directly to the Structures Management Unit.
5. The two sets of preliminary submittals required by Article 1072-8 of the *Standard Specifications* are not required for these items.
6. Submittals for Fabrication Drawings are not required. Submittals for Catalogue Cuts of Proposed Material are required. See Section 5.A of the referenced provision.
7. Submittals are necessary only when the top slab thickness is 18” or greater.

GEOTECHNICAL SUBMITTALS

Submittal	Submittals Required by Geotechnical Engineering Unit	Submittals Required by Structures Management Unit	Contract Reference Requiring Submittal ¹
Drilled Pier Construction Plans ²	Y	N	Subarticle 411-3(A)
Crosshole Sonic Logging (CSL) Reports ²	Y	N	Subarticle 411-5(A)(2)
Pile Driving Equipment Data Forms ^{2,3}	Y	N	Subarticle 450-3(D)(2)
Pile Driving Analyzer (PDA) Reports ²	Y	N	Subarticle 450-3(F)(3)
Retaining Walls ⁴	Y; drawings and calculations	Y; drawings	Applicable Provisions
Temporary Shoring ⁴	Y; drawings and calculations	Y; drawings	“Temporary Shoring” & “Temporary Soil Nail Walls”

FOOTNOTES

- References are provided to help locate the part of the contract where the submittals are required. References in quotes refer to the provision by that name. Subarticles refer to the *Standard Specifications*.
- Submit one hard copy of submittal to the Engineer. Submit a second copy of submittal electronically (PDF via email), US mail or other delivery service to the appropriate Geotechnical Engineering Unit regional office. Electronic submission is preferred.
- The Pile Driving Equipment Data Form is available from:
<https://connect.ncdot.gov/projects/construction/ConstManRefDocs/PILE%20DRIVING%20EQUIPMENT%20DATA%20FORM.pdf>
 See second page of form for submittal instructions.
- Electronic copy of submittal is required. See referenced provision.

Project U-3609B

ST-14

Wayne County

CRANE SAFETY**(11-30-23)****GENERAL**

Comply with the manufacturer specifications and limitations applicable to the operation of any and all cranes and derricks. Prime contractors, sub-contractors, and fully operated rental companies shall comply with the current Occupational Safety and Health Administration (OSHA) regulations.

Submit all items listed below to the Engineer prior to beginning crane operations. Changes in personnel or equipment must be reported to the Engineer and all applicable items listed below must be updated and submitted prior to continuing with crane operations.

CRANE SAFETY SUBMITTAL LIST

- (A) **Competent Person:** Provide the name and qualifications of the “Competent Person” responsible for crane safety and lifting operations. The named competent person will have the responsibility and authority to stop any work activity due to safety concerns.
- (B) **Riggers:** Provide the qualifications and experience of the persons responsible for rigging operations. Qualifications and experience should include, but not be limited to, weight calculations, center of gravity determinations, selection and inspection of sling and rigging equipment, and safe rigging practices.
- (C) **Crane Inspections:** Inspection records for all cranes shall be current and readily accessible for review upon request.
- (D) **Certifications:** Crane operators shall be certified by the National Commission for the Certification of Crane Operators (NCCCO) or the National Center for Construction Education and Research (NCCER). Other approved nationally accredited programs will be considered upon request. In addition, crane operators shall have a current CDL medical card. Submit a list of crane operator(s) and include current certification for each type of crane operated (small hydraulic, large hydraulic, small lattice, large lattice) and medical evaluations for each operator.

MEASUREMENT AND PAYMENT

No direct payment will be made for *Crane Safety*. All costs shall be considered incidental to items for which direct payment is made.

Project U-3609B

ST-15

Wayne County

GROUT FOR STRUCTURES**(12-1-17)****GENERAL**

This Special Provision addresses grout for use in pile blockouts, grout pockets, shear keys, dowel holes and recesses for structures. This Special Provision does not apply to grout placed in post-tensioning ducts for bridge beams, girders, decks, end bent caps, or bent caps. Mix and place grout in accordance with the manufacturer's recommendations, the applicable sections of the *Standard Specifications* and this Special Provision.

MATERIAL REQUIREMENT

Unless otherwise noted on the plans, use a Type 3 Grout in accordance with Section 1003 of the *Standard Specifications*.

Initial setting time shall not be less than 10 minutes when tested in accordance with ASTM C266.

Construction loading and traffic loading shall not be allowed until the 3-day compressive strength is achieved.

SAMPLING AND PLACEMENT

Place and maintain components in final position until grout placement is complete and accepted. Concrete surfaces to receive grout shall be free of defective concrete, laitance, oil, grease, and other foreign matter. Saturate concrete surfaces with clean water and remove excess water prior to placing grout.

MEASUREMENT AND PAYMENT

No separate payment will be made for *Grout for Structures*. The cost of the material, equipment, labor, placement, and any incidentals necessary to complete the work shall be considered incidental to the structure item requiring grout.

PROJECT SPECIAL PROVISION

(10-18-95) (Rev. 10-15-24)

Z-1

PERMITS

The Contractor's attention is directed to the following permits, which have been issued to the Department of Transportation by the authority granting the permit.

<u>PERMIT</u>	<u>AUTHORITY GRANTING THE PERMIT</u>
Dredge and Fill and/or Work in Navigable Waters (404)	U. S. Army Corps of Engineers
Water Quality (401)	Division of Water Resources, DEQ State of North Carolina
Buffer Certification	Division of Water Resources, DEQ State of North Carolina

The Contractor shall comply with all applicable permit conditions during construction of this project.

Agents of the permitting authority will periodically inspect the project for adherence to the permits.

The Contractor's attention is also directed to Articles 107-10 and 107-13 of the *Standard Specifications* and the following:

Should the Contractor propose to utilize construction methods (such as temporary structures or fill in waters and/or wetlands for haul roads, work platforms, cofferdams, etc.) not specifically identified in the permit (individual, general, or nationwide) authorizing the project it shall be the Contractor's responsibility to coordinate with the Engineer to determine what, if any, additional permit action is required. The Contractor shall also be responsible for initiating the request for the authorization of such construction method by the permitting agency. The request shall be submitted through the Engineer. The Contractor shall not utilize the construction method until it is approved by the permitting agency. The request normally takes approximately 60 days to process; however, no extensions of time or additional compensation will be granted for delays resulting from the Contractor's request for approval of construction methods not specifically identified in the permit.

Where construction moratoriums are contained in a permit condition which restricts the Contractor's activities to certain times of the year, those moratoriums will apply only to the portions of the work taking place in the restricted waters, wetlands or buffer zones, provided that activities outside those areas is done in such a manner as to not affect the restricted waters, wetlands or buffer zones.



STATE OF NORTH CAROLINA
DEPARTMENT OF TRANSPORTATION

JOSH STEIN
GOVERNOR

DANIEL H. JOHNSON
SECRETARY

December 23, 2025

MEMORANDUM TO: Division Construction Units
Contract Standards and Development Unit

FROM: Garry Wright, Division Environmental Unit
Division 4 Project Development Unit

SUBJECT: Environmental Permits for the US Hwy 13 from SR1003 to
SR1572 in Wayne County, Division 4, **TIP: U-3609B.**

Please find enclosed the following permits for this project:

Agency	Permit Type	Permit Expiration
US Army Corps of Engineers Section 404 Clean Water Act Permit	Regional General Permit 50	May 25, 2025 Grace period until May 25, 2026 Currently being renewed by USACE
NC Division of Water Resources Section 401 Water Quality Certification	General Certification No. 4135 [RGP50]	May 25, 2030
NC Division of Water Resources Buffer Certification	Neuse River and Jordan Lake Water Supply Riparian Buffer Certification	December 18, 2030

Work is authorized by the above referenced permit provided it is accomplished in strict accordance with the permitted plans.

The Environmental Coordination and Permitting Group or the Division Environmental Office must be consulted if any deviation from the permit(s) is required.

The General Conditions and Certifications for Nationwide and Regional Permits can be referenced at:

https://xfer.services.ncdot.gov/pdea/PermIssued/_General_Conditions_and_Certifications/

Future/ When the project greensheet is only found in on the Commitment Tracker in SharePoint:

The Project Commitments “Greensheet” is located on the Preconstruction SharePoint Dashboard at:<https://connect.ncdot.gov/site/preconstruction>

Mailing Address:
NC DEPARTMENT OF TRANSPORTATION
DIVISION OF HIGHWAYS
P.O. BOX 3165
WILSON, NC 27895-3165

Telephone: (252) 640-6400
Fax: (252) 234-6174
Customer Service: 1-877-368-4968

Website: www.ncdot.gov

Location:
509 WARD BOULEVARD
WILSON, NC 27893

P-3

U.S. ARMY CORPS OF ENGINEERS WILMINGTON DISTRICT

Action Id. SAW-2023-01524 County: Wayne County U.S.G.S. Quad: Northeast Goldsboro

GENERAL PERMIT (REGIONAL AND NATIONWIDE) VERIFICATION

Permittee: Garry Wright
NCDOT-Div. 4

Address: Post Office Box 3165
Wilson NC, 27895

Telephone Number: (252) 725-5439

Size (acres) 2.53 Nearest Town Goldsboro
Nearest Waterway Bear Creek River Basin Neuse
USGS HUC 03020202 Coordinates Latitude: 35.404139; Longitude: -77.899051

Location description: The project is located on US 13 between New Hope Road and Saulston Road, east of the town of Goldsboro in Wayne County, North Carolina.

Description of projects area and activity: NCDOT proposes to upgrade US 13 (Berkley Blvd) from a 2-lane road to a 4-lane road from New Hope Road to north of Saulston Road. The project will include access management elements such as U-turn bulbs. The project is covers 3.6 miles within the same alignment. The project will permanently impact 360 linear feet of streams and 0.5 acres of wetlands.

Applicable Law: Section 404 (Clean Water Act, 33 USC 1344);
 Section 10 (Rivers and Harbors Act, 33 USC 403)

Authorization: Regional General Permit Number and/or Nationwide Permit Number: RGP50
SEE ATTACHED RGP or NWP GENERAL, REGIONAL AND/OR SPECIAL CONDITIONS

Your work is authorized by the above referenced permit provided it is accomplished in strict accordance with the attached conditions and your submitted application and attached information dated November 22, 2023. Any violation of the attached conditions or deviation from your submitted plans may subject the permittee to a stop work order, a restoration order, a Class I administrative penalty, and/or appropriate legal action.

This verification will remain valid until the expiration date identified below unless the nationwide and/or regional general permit authorization is modified, suspended or revoked. If, prior to the expiration date identified below, the nationwide and/or regional general permit authorization is reissued and/or modified, this verification will remain valid until the expiration date identified below, provided it complies with all requirements of the modified nationwide permit. If the nationwide and/or regional general permit authorization expires or is suspended, revoked, or is modified, such that the activity would no longer comply with the terms and conditions of the nationwide permit, activities which have commenced (i.e., are under construction) or are under contract to commence in reliance upon the nationwide and/or regional general permit, will remain authorized provided the activity is completed within twelve months of the date of the nationwide and/or regional general permit's expiration, modification or revocation, unless discretionary authority has been exercised on a case-by-case basis to modify, suspend or revoke the authorization.

P-4

Activities subject to Section 404 (as indicated above) may also require an individual Section 401 Water Quality Certification. You should contact the NC Division of Water Resources (telephone 919-807-6300) to determine Section 401 requirements.

For activities occurring within the twenty coastal counties subject to regulation under the Coastal Area Management Act (CAMA), prior to beginning work you must contact the N.C. Division of Coastal Management in Morehead City, NC, at (252) 808-2808.

This Department of the Army verification does not relieve the permittee of the responsibility to obtain any other required Federal, State or local approvals/permits.

If there are any questions regarding this verification, any of the conditions of the Permit, or the Corps of Engineers regulatory program, please contact **Kyle Barnes at (910) 251-4584 or Kyle.W.Barnes@usace.army.mil.**

*Monte
Matthew*
2023.12.19
14:56:48
-05'00'

Corps Regulatory Official: _____ Date: **December 19, 2023**
Expiration Date of Verification: **May 25, 2025**

The Wilmington District is committed to providing the highest level of support to the public. To help us ensure we continue to do so, please complete our Customer Satisfaction Survey, located online at <https://regulatory.ops.usace.army.mil/customer-service-survey/>

SAW-2023-01524

SPECIAL CONDITIONS

1. The Wilmington District, Federal Highway Administration, U.S. Fish and Wildlife Service (USFWS), and the North Carolina Department of Transportation (NCDOT) have conducted programmatic Section 7(a)(2) consultation for the Northern long-eared bat (NLEB) for NCDOT projects located in Divisions 1-8. The result of this programmatic consultation is a Programmatic Biological Opinion (PBO) issued by the USFWS titled, "Programmatic Biological Opinion – Revised, NCDOT Program Effects on the Northern Long-eared Bat in Divisions 1-8", dated December 15, 2022. This PBO contains agreed upon conservation measures which would minimize take of NLEB. As noted in the PBO, applicability of these conservation measures varies depending on the location of the project. The USFWS has documented that no reasonable and prudent measures, nor terms and conditions, are necessary or appropriate to minimize the amount or extent of incidental take of NLEB caused by the Action; therefore, the incidental take statement does not provide reasonable and prudent measures for this species. Department of the Army (DA) authorization under general permit or standard permit (Individual Permit) is conditional upon the permittee's compliance with applicable, agreed upon conservations measures of the PBO, which is incorporated by reference in this verification letter. Failure to comply with the applicable conservation measures, where a take of the NLEB occurs, would constitute an unauthorized take by the permittee, and would also constitute permittee non-compliance with this verification letter. The USFWS is the appropriate authority to determine compliance with the terms and conditions of its PBO and the ESA. All PBOs can be found on our website at: <https://www.saw.usace.army.mil/Missions/Regulatory-Permit-Program/Agency-Coordination/ESA/>.
2. In order to compensate for impacts associated with this permit, mitigation shall be provided in accordance with the provisions outlined on the most recent version of the attached Compensatory Mitigation Responsibility transfer form. The requirements of this form, including any special conditions listed on this form, are hereby incorporated as special conditions of this permit authorization.
3. "Tri-colored bat - No tree clearing will occur within 150 feet of a known maternity roost tree May 1 - July 31 in order to protect non-volant young. Winter roost trees are not considered maternity roost trees. NCDOT will cross-reference information given by USFWS on the locations of maternity roosts (as they are discovered) to stay in compliance with this condition."

P-6

Action ID Number: SAW-2023-01524

County: Wayne County

Permittee: Garry Wright
NCDOT-Div. 4

Project Name: NCDOT U-3609B Berkley Blvd. Wayne

Date Verification Issued: December 18, 2023

Project Manager: Kyle Barnes

Upon completion of the activity authorized by this permit and any mitigation required by the permit, sign this certification and return it to the following address:

US ARMY CORPS OF ENGINEERS
WILMINGTON DISTRICT
Attn: Kyle Barnes

Please note that your permitted activity is subject to a compliance inspection by a U. S. Army Corps of Engineers representative. Failure to comply with any terms or conditions of this authorization may result in the Corps suspending, modifying or revoking the authorization and/or issuing a Class I administrative penalty, or initiating other appropriate legal action.

I hereby certify that the work authorized by the above referenced permit has been completed in accordance with the terms and condition of the said permit, and required mitigation was completed in accordance with the permit conditions.

Signature of Permittee

Date

DEPARTMENT OF THE ARMY
Wilmington District, Corps of Engineers
69 Darlington Avenue
Wilmington, North Carolina 28403-1343

Regional General Permit No. SAW-2019-02350 (RGP 50)
Name of Permittee: North Carolina Department of Transportation
Effective Date: May 26, 2020
Expiration Date: May 25, 2025

**DEPARTMENT OF THE ARMY
REGIONAL GENERAL PERMIT**

A regional general permit (RGP) to perform work in or affecting navigable waters of the United States and waters of the United States, upon recommendation of the Chief of Engineers, pursuant to Section 10 of the Rivers and Harbors Act of March 3, 1899 (33 U.S.C. 403), and Section 404 of the Clean Water Act (33 U.S.C. 1344), is hereby issued by authority of the Secretary of the Army by the

District Commander
U.S. Army Engineer District, Wilmington
Corps of Engineers
69 Darlington Avenue
Wilmington, North Carolina 28403-1343

TO AUTHORIZE THE DISCHARGE OF DREDGED OR FILL MATERIAL IN WATERS OF THE UNITED STATES (U.S.), INCLUDING WETLANDS, ASSOCIATED WITH MAINTENANCE, REPAIR, AND CONSTRUCTION PROJECTS CONDUCTED BY THE VARIOUS DIVISIONS OF THE NORTH CAROLINA DEPARTMENT OF TRANSPORTATION (NCDOT), INCLUDING THE NCDOT DIVISION OF HIGHWAYS, RAIL, BICYCLE/PEDESTRIAN, ETC.

Activities authorized by this RGP:

- a. (1) Road widening, and/or (2) construction, maintenance, and/or repair of bridges. For bridge projects, work can include the approaches.
- b. (1) Improvement of interchanges or intersections, or (2) construction of interchanges or intersections over, or on, existing roads.

Full descriptions/terms of “a” and “b”:

a. (1) Road widening, and/or (2) construction, maintenance, and/or repair of bridges. For bridge projects, work can include the approaches.

Permanent impacts that result in a loss of waters of the U.S., excluding stream relocation(s), must be less than or equal to 500 linear feet (lf) of stream and/or one (1) acre of wetland/open water for each single and complete linear project.

Single and complete linear project. As noted in 33 CFR 330.2(i), for linear projects, the “single and complete project” (i.e., single and complete crossing) will apply to each crossing of a separate water of the U.S. (i.e., single waterbody) at that location; except that for linear projects crossing a single waterbody several times at separate and distant locations, each crossing is considered a single and complete project. However, individual channels in a braided stream or river, or individual arms of a large, irregularly-shaped wetland or lake, etc., are not separate waterbodies and crossing of such features cannot be considered separately.

Also authorized under “a”: (1) stream relocation(s) and (2) temporary impacts, such as those from temporary structures, fills, dewatering, and other work necessary to conduct the activities listed under “a”. Stream relocation(s) and temporary impacts will be evaluated independently and are not limited to the permanent loss limits of 500 lf of stream and/or 1 acre of wetland/open water (i.e., stream relocations and/or temporary impacts do not factor into these limits) for each single and complete linear project; however, if the Corps determines that the proposed stream relocation(s) and/or temporary impacts are of such magnitude that they cannot be authorized under this section (“a”) of RGP 50, even if the permanent losses from road widening, and/or construction, maintenance, and repair of bridges do not exceed the impact limits for this section (“a”) of RGP 50, an Individual Permit will be required.

If the Corps determines, on a case-by-case basis, that the concerns for the aquatic environment so indicate, he/she may exercise discretionary authority to override this RGP and require an Individual Permit.

b. (1) Improvement of interchanges or intersections, or (2) construction of interchanges or intersections, over or, on existing roads.

For activities authorized under “b”, the limits for permanent impacts that result in a loss of waters of the U.S. depend on the location of the impacts, as described below:

- In the coastal plain of North Carolina (both inner coastal plain and outer coastal plain) - permanent impacts that result in a loss of waters of the U.S., excluding stream relocation(s), must be less than or equal to 1,000 lf of stream and/or 3 acres of wetland/open water for the entire interchange or intersection project.

- All other areas of North Carolina - permanent impacts that result in a loss of waters of the U.S., excluding stream relocation(s), must be less than or equal to 1,000 lf of stream and/or 2 acres of wetland/open water for the entire interchange or intersection project.

Coastal plain – See http://saw-reg.usace.army.mil/JD/LRRs_PandT.pdf for Land Resource Areas LRRP (inner coastal plain) and LRRT (outer coastal plain).

When proposed impacts to waters of the U.S. are located both inside AND outside of the coastal plain, the Corps will determine, based on the location(s) of proposed impacts to waters of the U.S., if a project is a “coastal plain project”.

Single and complete project. For permitting purposes, each interchange or intersection is considered to be one single and complete project. For example, an interchange project cannot result in a permanent loss (excluding stream relocation), of (1) greater than 1,000 lf of stream and/or 3 acres of wetland/open water in the coastal plain OR (2) greater than 1,000 lf of stream and/or 2 acres of wetland/open water in all other areas of North Carolina.

Approach fills may be considered to be part of an interchange or intersection project if the Corps determines that inclusion of these areas meet the terms of this section (“b”) of RGP 50. Early coordination with the Corps is encouraged.

Intersections, regardless of the mode of transportation (e.g., railroad, other roadways, etc.), may be at grade or grade separated if the Corps determines that the project would meet the terms of this section (“b”) of RGP 50. Early coordination with the Corps is encouraged.

Also authorized under “b”: (1) stream relocation(s) and (2) temporary impacts, such as those from temporary structures, fills, dewatering, and other work necessary to conduct the activities listed under “b”. Stream relocation(s) and temporary impacts will be evaluated independently and are not limited to the permanent loss limits of (1) 1,000 lf of stream and/or 3 acres of wetland/open water in the coastal plain OR (2) 1,000 lf of stream and/or 2 acres of wetland/open water in all other areas of North Carolina (i.e., stream relocations and/or temporary impacts do not factor into these limits) for each interchange or intersection project; however, if the Corps determines that the proposed stream relocation(s) and/or temporary impacts are of such magnitude that they cannot be authorized under this section (“b”) of RGP 50, even if the permanent losses from improvement of interchanges or intersections, or construction of interchanges or intersections over, or on, existing roads do not exceed the impact limits for this section (“b”) of RGP 50, an Individual Permit will be required.

If the Corps determines, on a case-by-case basis, that the concerns for the aquatic environment so indicate, he/she may exercise discretionary authority to override this RGP and require an Individual Permit.

1. Special Conditions.

a. The prospective permittee must submit a pre-construction notification (PCN) and applicable supporting information to the District Engineer and receive written verification from the Corps that the proposed work complies with this RGP prior to commencing any activity authorized by this RGP.

b. If the project will not impact a designated “Area of Environmental Concern” (AEC) in the twenty* (20) counties of North Carolina covered by the North Carolina Coastal Area Management Act (CAMA) (“CAMA counties”), a consistency submission is not required. If the project will impact a designated AEC and meets the definition of “development”, the prospective permittee must obtain the required CAMA permit. Development activities shall not commence until a copy of the approved CAMA permit is furnished to the appropriate Corps Regulatory Field Office (Wilmington Field Office – 69 Darlington Avenue, Wilmington, NC 28403 or Washington Field Office – 2407 West 5th Street, Washington, NC 27889).

***The 20 CAMA counties in North Carolina include Beaufort, Bertie, Brunswick, Camden, Carteret, Chowan, Craven, Currituck, Dare, Gates, Hertford, Hyde, New Hanover, Onslow, Pamlico, Pasquotank, Pender, Perquimans, Tyrrell, and Washington.**

c. No work shall be authorized by this RGP within the 20* CAMA counties without prior consultation with the National Oceanic and Atmospheric Administration’s (NOAA) Habitat Conservation Division. For each activity reviewed by the Corps where it is determined that the activity may affect Essential Fish Habitat (EFH) for federally managed species, an EFH Assessment shall be prepared by the prospective permittee and forwarded to the Corps and NOAA Fisheries for review and comment prior to authorization of work.

d. Culverts and pipes. The following conditions [(1)-(8)] apply to the construction of culverts/pipes, and work on existing culverts/pipes.

Additionally, if the proposed work would affect an existing culvert/pipe (e.g., culvert/pipe extensions), the prospective permittee must include actions (in the PCN) to correct any existing deficiencies that are located:

- At the inlet and/or outlet of the existing culvert/pipe, IF these deficiencies are/were caused by the existing culvert/pipe, or
- Near the inlet or outlet of the existing culvert/pipe, IF these deficiencies are/were caused by the existing culvert/pipe.

P-11

These deficiencies may include, but are not limited to, stream over-widening, bank erosion, streambed scour, perched culvert/pipes, and inadequate water depth in culvert(s). Also note if the proposed work would address the existing deficiency or eliminate it – e.g., bank erosion on left bank, but the culvert extension will be placed in this eroded area. If the prospective permittee is unable to correct the deficiencies caused by the existing culvert/pipe, they must document the reasons in the PCN for Corps consideration.

(1) No activity may result in substantial, permanent disruption of the movement of those species of aquatic life indigenous to the waterbody, including those species that normally migrate through the area. Measures will be included that will promote the safe passage of fish and other aquatic organisms.

(2) The dimension, pattern, and profile of the stream above and below a culvert/pipe shall not be modified by widening the stream channel or by reducing the depth of the stream in connection with the construction activity. It is acceptable to use rock vanes at culvert/pipe outlets to ensure, enhance, or maintain aquatic passage. Pre-formed scour holes are acceptable when designed for velocity reduction. The width, height, and gradient of a proposed opening shall be such as to pass the average historical low flow and spring flow without adversely altering flow velocity. Spring flow will be determined from gauge data, if available. In the absence of such data, bankfull flow will be used as a comparable level.

(3) Burial/depth specifications: If the project is located within any of the 20* CAMA counties, culvert/pipe inverts will be buried at least one foot below normal bed elevation when they are placed within the Public Trust AEC and/or the Estuarine Waters AEC as designated by CAMA. If the project is located outside of the 20* CAMA counties, culvert/pipe inverts will be buried at least one foot below the bed of the stream for culverts/pipes that are greater than 48 inches in diameter. Culverts/pipes that are 48 inches in diameter or less shall be buried or placed on the stream bed as practicable and appropriate to maintain aquatic passage, to include passage during drought or low flow conditions. Every effort shall be made to maintain the existing channel slope. A waiver from the burial/depth specifications in this condition may be requested in writing. The prospective permittee is encouraged to request agency input about waiver requests as early as possible, and prior to submitting the PCN for a specific project; this will allow the agencies time to conduct a site visit, if necessary, and will prevent time delays and potential project revisions for the prospective permittee. The waiver will only be issued by the Corps if it can be demonstrated that the impacts of complying with burial requirements would result in more adverse impacts to the aquatic environment.

(4) Appropriate actions to prevent destabilization of the channel and head cutting upstream shall be incorporated in the design and placement of culverts/pipes.

(5) Culverts/pipes placed within riparian and/or riverine wetlands must be installed in a manner that does not restrict the flow and circulation patterns of waters of the U.S. Culverts/pipes placed across wetland fills purely for the purposes of equalizing surface

P-12

water do not have to be buried, but must be of adequate size and/or number to ensure unrestricted transmission of water.

(6) Bankfull flows (or less) shall be accommodated through maintenance of the existing bankfull channel cross sectional area in no more than one culvert/pipe or culvert/pipe barrel. Additional culverts/pipes or barrels at such crossings shall be allowed only to receive flows exceeding the bankfull flow. A waiver from this condition may be requested in writing; this request must be specific as to the reason(s) for the request. The waiver will be issued if it can be demonstrated that it is not practicable to comply with this condition.

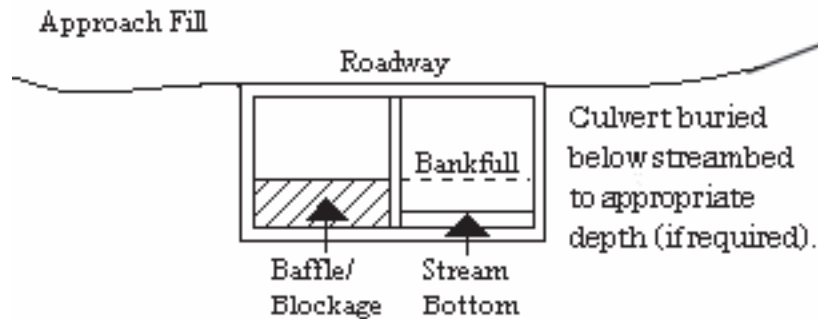

(7) Where adjacent floodplain is available, flows exceeding bankfull will be accommodated by installing culverts/pipes at the floodplain elevation. When multiple culverts/pipes are used, baseflow must be maintained at the appropriate width and depth by the construction of floodplain benches, sills, and/or construction methods to ensure that the overflow culvert(s)/pipe(s) is elevated above the baseflow culvert(s)/pipe(s).

(8) The width of the baseflow culvert/pipe shall be comparable to the width of the bankfull width of the stream channel. If the width of the baseflow culvert/pipe is wider than the stream channel, the culvert/pipe shall include baffles, benches and/or sills to maintain the width of the stream channel. A waiver from this condition may be requested in writing; this request must be specific as to the reason(s) for the request. The waiver will be issued if it can be demonstrated that it is not practicable or necessary to include baffles, benches or sills.

See the remaining special conditions for additional information about culverts/pipes in specific areas.

e. Discharges into waters of the U.S. designated by either the North Carolina Division of Marine Fisheries (NCDMF) or the North Carolina Wildlife Resources Commission (NCWRC) as anadromous fish spawning areas are prohibited during the period between February 15th and June 30th, without prior written approval from the Corps and the appropriate wildlife agencies (NCDMF, NCWRC, and/or the National Marine Fisheries Service (NMFS)). Discharges into waters of the U.S. designated by NCWRC as primary nursery areas in inland waters are prohibited during the period between February 15th and September 30th, without prior written approval from the Corps and the appropriate wildlife agencies. Discharges into waters of the U.S. designated by NCDMF as primary nursery areas shall be coordinated with NCDMF prior to being authorized by

this RGP. Coordination with NCDMF may result in a required construction moratorium during periods of significant biological productivity or critical life stages.

The prospective permittee should contact:

NC Division of Marine Fisheries	North Carolina Wildlife Resources Commission
3441 Arendell Street	Habitat Conservation Division
Morehead City, NC 28557	1721 Mail Service Center
Telephone 252-726-7021	Raleigh, NC 27699-1721
or 800-682-2632	Telephone (919) 707-0220

f. This permit does not authorize the use of culverts in areas designated as anadromous fish spawning areas by the NCDMF or the NCWRC.

g. No in-water work shall be conducted in Waters of the U.S. designated as Atlantic sturgeon critical habitat during the periods between February 1st and June 30th. No in-water work shall be conducted in Waters of the U.S. in the Roanoke River designated as Atlantic sturgeon critical habitat during the periods between February 1st and June 30th, and between August 1st to October 31st, without prior written approval from NMFS.

h. Before discharging dredged or fill material into waters of the U.S. in designated trout watersheds in North Carolina, the PCN will be sent to the NCWRC and the Corps concurrently. See <https://www.saw.usace.army.mil/Missions/Regulatory-Permit-Program/Agency-Coordination/Trout.aspx> for the designated trout watersheds. The PCN shall summarize alternatives to conducting work in waters of the U.S. in trout watersheds that were considered during the planning process and detail why alternatives were or were not selected. For proposals where (1) a bridge in a trout stream will be replaced with a culvert, or (2) a culvert will be placed in a trout stream, the PCN must also include a compensatory mitigation plan for all loss of stream bed, and details of any on-site evaluations that were conducted to determine that installation of a culvert will not adversely affect passage of fish or other aquatic biota at the project site. The evaluation information must include factors such as the proposed slope of the culvert and determinations of how the slope will be expected to allow or impede passage, the necessity of baffles and/or sills to ensure passage, design considerations to ensure that expected baseflow will be maintained for passage and that post-construction velocities will not prevent passage, site conditions that will or will not allow proper burial of the culvert, existing structures (e.g., perched culverts, waterfalls, etc.) and/or stream patterns up and downstream of the culvert site that could affect passage and bank stability, and any other considerations regarding passage. The level of detail for this information shall be based on site conditions (i.e., culverts on a slope over 3% will most likely require more information than culverts on a slope that is less than 1%, etc.). Also, in order to evaluate potential impacts, the prospective permittee will describe bedforms that will be impacted by the proposed culvert – e.g., pools, glides, riffles, etc. The NCWRC will respond to both the prospective permittee and the Corps.

P-14

i. For all activities authorized by this RGP that involve the use of riprap material for bank stabilization, the following measures shall be applied:

(1) Where bank stabilization is conducted as part of an activity, natural design, bioengineering, and/or geoengineering methods that incorporate natural durable materials, native seed mixes, and native plants and shrubs are to be utilized, as appropriate to site conditions, to the maximum extent practicable.

(2) Filter cloth must be placed underneath the riprap as an additional requirement of its use in North Carolina waters; however, the prospective permittee may request a waiver from this requirement. The waiver request must be in writing. The Corps will only issue a waiver if the prospective permittee demonstrates that the impacts of complying with this requirement would result in greater adverse impacts to the aquatic environment. Note that filter fabric is not required if the riprap will be pushed or “keyed” into the bank of the waterbody.

(3) The placement of riprap shall be limited to the areas depicted on submitted work plan drawings.

(4) Riprap shall not be placed in a manner that prevents or impedes fish passage.

(5) Riprap shall be clean and free from loose dirt or any pollutant except in trace quantities that will not have an adverse environmental effect.

(6) Riprap shall be of a size sufficient to prevent its movement from the authorized alignment by natural forces under normal conditions.

(7) Riprap material shall consist of clean rock or masonry material such as, but not limited to, granite, marl, or broken concrete.

j. Discharges of dredged or fill material into waters of the U.S., including wetlands, must be minimized or avoided to the maximum extent practicable.

k. Generally, off-site detours are preferred to avoid and minimize impacts to the human and natural environment; however, if an off-site detour is considered impracticable, then an on-site detour may be considered as a necessary component of the actions authorized by this RGP. Impacts from the detour may be considered temporary and may not require compensatory mitigation if the impacted area is restored to pre-construction elevations and contours after construction is complete. The permittee shall also restore natural hydrology and stream corridors (if applicable), and reestablish native vegetation/riparian corridors. If the construction of a detour (on-site or off-site) includes standard undercutting methods, removal of all material and backfilling with suitable material is required. See special condition “s” for additional information.

l. All activities authorized by this RGP shall, to the maximum extent practicable, be

conducted "in the dry", with barriers installed between work areas and aquatic habitat to protect that habitat from sediment, concrete, and other pollutants. Where concrete is utilized, measures will be taken to prevent live or fresh concrete, including bags of uncured concrete, from coming into contact with waters of the U.S. until the concrete has set and cured. All water in the work area that has been in contact with concrete shall only be returned to waters of the U.S. when it no longer poses a threat to aquatic organisms (concrete is set and cured).

m. In cases where new alignment approaches are to be constructed and the existing approach fill in waters of the U.S. is to be abandoned and no longer maintained as a roadway, the abandoned fill shall be removed and the area will be restored to pre-construction elevations and contours. The permittee shall also restore natural hydrology and stream corridors (if applicable), and reestablish native vegetation/riparian corridors, to the extent practicable. This activity may qualify as compensatory mitigation credit for the project and will be assessed on a case-by-case basis in accordance with Special Conditions "q" and "r" in this document. Any proposed on-site wetland restoration area must be void of utility conflicts and/or utility maintenance areas. A restoration plan detailing this activity will be required with the submittal of the PCN.

n. To the maximum extent practicable, the pre-construction course, condition, capacity, and location of open waters must be maintained for each activity, including stream channelization and storm water management activities, except as provided below. The activity must be constructed to withstand expected high flows. The activity must not restrict or impede the passage of normal or high flows, unless the primary purpose of the activity is to impound water or manage high flows. The activity may alter the pre-construction course, condition, capacity, and location of open waters if it benefits the aquatic environment (e.g., stream restoration or relocation activities).

o. The project must be implemented and/or conducted so that all reasonable and practicable measures to ensure that equipment, structures, fill pads, and work associated with the project do not adversely affect upstream and/or downstream reaches. Adverse effects include, but are not limited to, channel instability, scour, flooding, and/or shoreline/streambank erosion. During construction, the permittee shall routinely monitor for these effects, cease all work if/when detected, take initial corrective measures to correct actively eroding areas, and notify the Corps immediately. Permanent corrective measures may require additional authorization from the Corps.

p. All PCNs will describe sedimentation and erosion control structures and measures proposed for placement in waters of the U.S. To the maximum extent practicable, structures and measures will be depicted on maps, surveys or drawings showing location and impacts to jurisdictional wetlands and streams. In addition, appropriate soil and erosion control measures must be established and maintained during construction. All fills, temporary and permanent, must be adequately stabilized at the earliest practicable date to prevent erosion of fill material into adjacent waters or wetlands.

q. Compensatory mitigation will be required for permanent impacts resulting in a loss of waters of the U.S. due to culvert/pipe installation and other similar activities. Mitigation may be required for stream relocation projects (see Special Condition “r” below). When compensatory mitigation is required, the prospective permittee will attach a proposed mitigation plan to the PCN. Compensatory mitigation proposals will be written in accordance with currently approved Wilmington District guidance and Corps mitigation regulations, unless the purchase of mitigation credits from an approved mitigation bank or the North Carolina Division of Mitigation Services (NCDMS) is proposed to address all compensatory mitigation requirements. The Corps Project Manager will make the final determination concerning the appropriate amount and type of mitigation.

r. Stream Relocations (non-tidal only) - for the purposes of permitting, stream relocations are considered a loss of waters of the U.S. Depending on the condition and location of (1) the existing stream, and (2) the relocated channel, stream relocation(s) may provide a functional uplift. The Corps will determine if an uplift is possible based on the information submitted with the PCN. If the anticipated uplift(s) occurs, it may offset, either partially or fully, the loss associated with a stream relocation(s) - (i.e., due to the uplift, either no compensatory mitigation would be required for the stream relocation itself, or compensatory mitigation would be required at a reduced ratio).

Because the amount of potential uplift is dependent upon the condition (or quality) of the channel to be relocated, there is no pre-determined amount of uplift needed to satisfy the requirements for a successful relocation project. After performing the evaluation(s) noted in this document, the prospective permittee will propose a certain amount of uplift potential and the Corps project manager will make the final determination. Baseline conditions and subsequent monitoring must show that the relocated channel is providing/will provide aquatic function at, or above, the level provided by the baseline (pre-project) condition. If the required uplift is not achieved, the work will not be in compliance with this special condition of RGP 50 and remediation will be required through repair (and continued monitoring), or by the permittee providing compensatory mitigation (e.g., mitigation credit through an approved bank, mitigation credit through NCDMS, etc.).

Compensatory mitigation, in addition to the stream relocation activity, may be required if the Corps determines that (a) no uplift in stream function is achievable, (b) the proposed uplift in stream function is not sufficient, by itself, (c) the risks associated with achieving potential uplifts in stream function are excessive, and/or (d) the time period for achieving the potential uplifts/functional success is too great.

On-site compensatory mitigation is not the same as stream relocation. While stream relocation simply moves a stream to a nearby, geographically similar area, it does not generate mitigation credits. If NCDOT proposes to generate compensatory mitigation on a project site, NCDOT must submit a mitigation plan that complies with 33 CFR 332.4.

The prospective permittee is required to submit the following information for any proposed project that involves stream relocation, regardless of the size/length of the stream relocation (note that 1-5 below only apply to stream relocations and not to compensatory mitigation):

- (1) A statement detailing why relocating the stream is unavoidable. In order to ensure that this action is separate from a compensatory mitigation project, the need for the fill must be related to road/interchange/intersection construction or improvement, and the project must meet the requirements set forth in the full descriptions/terms of “a” and “b” on pages 2 and 3 of this permit.
- (2) An evaluation of effects on the relocated stream and buffer from utilities, or potential for impact from utility placement in the future.
- (3) An evaluation of the baseline condition of the stream to be relocated. In order to demonstrate a potential uplift, the prospective permittee must provide the baseline (pre-impact) condition of the stream that is proposed for relocation. The prospective permittee will document the baseline condition of the stream by using the Corps’ (Wilmington District’s) current functional assessment method - e.g., the North Carolina Stream Assessment Method (NCSAM). The functional assessment must be used to identify specific areas where an uplift would reasonably be expected to occur, and also show important baseline functions that will remain after the relocation.
- (4) An evaluation of the potential uplifts to stream function for the relocated channel. The amount of detail required in the plan will be commensurate with the functional capacity of the original stream and proposed uplift(s). Low functional capacity will warrant less monitoring and less detail in the plan in order to ensure that the relocated channel provides the same, or better/increased, suite of aquatic functions as the existing channel.
- (5) A proposed monitoring plan for the relocated channel (and buffer, if applicable), will be prepared in accordance with current District guidance. The level of detail needed in the plan will be directly related to the quality of baseline functions and the anticipated uplift, therefore it is recommended that a pre-application discussion occur with the Corps Project Manager as early as possible. For example, if the risk for achieving the anticipated functional uplift is moderate or low, or if there is a low amount of proposed uplift, less information and monitoring will be required in the proposed relocation plan; similar to the requirements found in the "2003 Stream Mitigation Guidelines". If the risk for uplift is higher, or if there is a high amount of proposed uplift, additional monitoring and information will be required, trending toward the prescriptions found in the most recent Wilmington District Compensatory Mitigation Guidance – e.g., the 2016 Wilmington District Stream and Wetland Compensatory Mitigation Update. All monitoring will be for at least 5 years unless the Corps project manager determines that (a) a specific project requires less than 5 years due to site conditions or limited risk/uplift potential, and/or complexity (or simplicity) of the existing channel and/or the

relocation work, or (b) the Corps project manager determines (during the monitoring period) that the 5 years of monitoring may be reduced (or that no further monitoring is required) based on monitoring information received once the stream relocation has been completed.

s. Upon completion of any work authorized by this RGP, all temporary fills (to include culverts, pipes, causeways, etc.) will be completely removed from waters of the U.S. and the areas will be restored to pre-construction elevations and contours. The permittee shall also restore natural hydrology and stream corridors (if applicable), and reestablish native vegetation/riparian corridors. This work will be completed within 60 days of completion of project construction. If this timeframe occurs while a required moratorium of this permit is in effect, the temporary fill shall be removed in its entirety within 60 days of the moratorium end date. If vegetation cannot be planted due to the time of the year, all disturbed areas will be seeded with a native mix appropriate for the impacted area, and vegetation will be planted during the next appropriate time frame. A native seed mix may contain non-invasive small grain annuals (e.g. millet and rye grain) to ensure adequate cover while native vegetation becomes established. The PCN must include a restoration plan showing how all temporary fills and structures will be removed and how the area will be restored to pre-project elevations and contours.

t. Once the authorized work in waters of the U.S. is complete, the permittee shall sign and return the compliance certificate that is attached to the RGP verification letter.

u. The District Engineer will consider any comments from Federal and/or State agencies concerning the proposed activity's compliance with the terms and conditions of this RGP.

v. The Corps may place additional special conditions, limitations, or restrictions on any verification of the use of RGP 50 on a project-by-project basis.

2. General Conditions.

a. Except as authorized by this RGP or any Corps approved modification to this RGP, no excavation, fill or mechanized land-clearing activities shall take place within waters or wetlands, at any time during construction or maintenance of the project. This permit does not authorize temporary placement or double handling of excavated or fill material within waters or wetlands outside the permitted area. This prohibition applies to all borrow and fill activities connected with the project.

b. Authorization under this RGP does not obviate the need to obtain other federal, state, or local authorizations.

c. All work authorized by this RGP must comply with the terms and conditions of the applicable CWA Section 401 Water Quality Certification for this RGP issued by the North Carolina Division of Water Resources (NCDWR).

d. The permittee shall employ all sedimentation and erosion control measures necessary to prevent an increase in sedimentation or turbidity within waters and wetlands outside of the permit area. This shall include, but is not limited to, the immediate installation of silt fencing or similar appropriate devices around all areas subject to soil disturbance or the movement of earthen fill, and the immediate stabilization of all disturbed areas. Additionally, the project must remain in full compliance with all aspects of the Sedimentation Pollution Control Act of 1973 (North Carolina General Statutes Chapter 113A Article 4).

e. The activities authorized by this RGP must not interfere with the public's right to free navigation on all navigable waters of the U.S. No attempt will be made by the permittee to prevent the full and free use by the public of all navigable waters at, or adjacent to, the authorized work for a reason other than safety.

f. The permittee understands and agrees that if future operations by the U.S. require the removal, relocation, or other alteration, of the structure or work herein authorized, or if, in the opinion of the Secretary of the Army or his authorized representative, said structure or work shall cause unreasonable obstruction to the free navigation of the navigable waters, the permittee will be required, upon due notice from the Corps, to remove, relocate, or alter the structural work or obstructions caused thereby, without expense to the U.S. No claim shall be made against the U.S. on account of any such removal or alteration.

g. The permittee, upon receipt of a notice of revocation of this RGP for the verified individual activity, may apply for an individual permit, or will, without expense to the U.S. and in such time and manner as the Secretary of the Army or his/her authorized representative may direct, restore the affected water of the U.S. to its former conditions.

h. This RGP does not authorize any activity that would conflict with a federal project's congressionally authorized purposes, established limitations or restrictions, or limit an agency's ability to conduct necessary operation and maintenance functions. Per Section 14 of the Rivers and Harbors Act of 1899, as amended (33 U.S.C. 408), no project that has the potential to take possession of or make use of for any purpose, or build upon, alter, deface, destroy, move, injure, or obstruct a federally constructed work or project, including, but not limited to, levees, dams, jetties, navigation channels, borrow areas, dredged material disposal sites, flood control projects, etc., shall be permitted unless the project has been reviewed and approved by the appropriate Corps approval authority. Permittees shall not begin the activity authorized by this RGP until notified by the Corps that the activity may proceed.

i. The permittee shall obtain a Consent to Cross Government Easement from the appropriate Corps District's Land Use Coordinator prior to any crossing of a Corps easement and/or prior to commencing construction of any structures, authorized dredging, or other work within the right-of-way of, or in proximity to, a federally designated disposal area.

j. The permittee will allow the Wilmington District Engineer or his/her representative to inspect the authorized activity at any time deemed necessary to ensure that the activity is being performed or maintained in strict accordance with the Special and General Conditions of this permit.

k. This RGP does not grant any property rights or exclusive privileges.

l. This RGP does not authorize any injury to the property or rights of others.

m. This RGP does not authorize the interference with any existing or proposed federal project.

n. In issuing this permit, the Federal Government does not assume any liability for the following:

(1) Damages to the permitted project or uses thereof as a result of other permitted or unpermitted activities or from natural causes.

(2) Damages to the permitted project or uses thereof as a result of current or future activities undertaken by or on behalf of the U.S. in the public interest.

(3) Damages to persons, property, or to other permitted or unpermitted activities or structures caused by the activity authorized by this permit.

(4) Design or construction deficiencies associated with the permitted work.

(5) Damage claims associated with any future modification, suspension, or revocation of this permit.

o. Authorization provided by this RGP may be modified, suspended or revoked in whole, or in part, if the Wilmington District Engineer, acting for the Secretary of the Army, determines that such action would be in the best public interest. The term of this RGP shall be five (5) years unless subject to modification, suspension, or revocation. Any modification, suspension, or revocation of this authorization will not be the basis for any claim for damages against the U.S. Government.

p. No activity may occur in a component of the National Wild and Scenic Rivers System, or in a river officially designated by Congress as a “study river” for possible inclusion in the system while the river is in an official study status, unless the appropriate Federal agency with direct management responsibility for such river, has determined in writing that the proposed activity will not adversely affect the Wild and Scenic designation or study status. Information on Wild and Scenic Rivers may be obtained from the appropriate Federal land management agency responsible for the designated Wild and Scenic River or “study river” (e.g., National Park Service, U.S. Forest Service, etc.).

q. Endangered Species.

(1) No activity is authorized under this RGP which is likely to directly or indirectly jeopardize the continued existence of a threatened or endangered species or a species proposed for such designation, as identified under the Federal Endangered Species Act (ESA), or which will directly or indirectly destroy or adversely modify the critical habitat of such species. No activity is authorized under this RGP which “may affect” a listed species or critical habitat, unless Section 7 consultation addressing the effects of the proposed activity has been completed.

(2) Federal agencies should follow their own procedures for complying with the requirements of the ESA. Federal prospective permittees (and when FHWA is the lead federal agency) must provide the District Engineer with the appropriate documentation to demonstrate compliance with those requirements. The District Engineer will review the documentation and determine whether it is sufficient to address ESA compliance for the RGP activity, or whether additional ESA consultation is necessary.

(3) Non-federal prospective permittees - for activities that might affect federally-listed endangered or threatened species or designated critical habitat, the PCN must include the name(s) of the endangered or threatened species that might be affected by the proposed work or that utilize the designated critical habitat that might be affected by the proposed work. The District Engineer will determine whether the proposed activity “may affect” or will have “no effect” to listed species and designated critical habitat. In cases where the non-federal prospective permittee has identified listed species or critical habitat that might be affected or is in the vicinity of the project, and has so notified the Corps, the prospective permittee shall not begin work until the Corps has provided notification that the proposed activities will have “no effect” on listed species or critical habitat, or until Section 7 consultation has been completed.

(4) As a result of formal or informal consultation with the U.S. Fish and Wildlife Service (USFWS) or NMFS, the District Engineer may add species-specific endangered species conditions to the RGP verification letter for a project.

(5) Authorization of an activity by a RGP does not authorize the “take” of a threatened or endangered species as defined under the ESA. In the absence of separate authorization (e.g., an ESA Section 10 Permit, a Biological Opinion with “incidental take” provisions, etc.) from the USFWS or the NMFS, the ESA prohibits any person subject to the jurisdiction of the U.S. to take a listed species, where "take" means to harass, harm, pursue, hunt, shoot, wound, kill, trap, capture, or collect, or to attempt to engage in any such conduct. The word “harm” in the definition of “take” means an act which actually kills or injures wildlife. Such an act may include significant habitat modification or degradation where it actually kills or injures wildlife by significantly impairing essential behavioral patterns, including breeding, feeding or sheltering.

(6) Information on the location of threatened and endangered species and their critical habitat can be obtained directly from the offices of the USFWS in North Carolina at the addresses provided below, or from the USFWS and NMFS via their world wide web pages at <http://www.fws.gov/> or <http://www.fws.gov/ipac> and <http://www.noaa.gov/fisheries.html> respectively.

USFWS offices in North Carolina:

The Asheville USFWS Office covers all NC counties west of, and including, Anson, Stanly, Davidson, Forsyth and Stokes Counties.

US Fish and Wildlife Service
Asheville Field Office
160 Zillicoa Street
Asheville, NC 28801
Telephone: (828) 258-3939

The Raleigh USFWS Office covers all NC counties east of, and including, Richmond, Montgomery, Randolph, Guilford, and Rockingham Counties.

US Fish and Wildlife Service
Raleigh Field Office
Post Office Box 33726
Raleigh, NC 27636-3726
Telephone: (919) 856-4520

r. The Wilmington District, USFWS, NCDOT, and the FHWA have conducted programmatic Section 7(a)(2) consultation for a number of federally listed species and habitat, and programmatic consultation concerning other federally listed species and/or habitat may occur in the future. The result of completed programmatic consultation is a Programmatic Biological Opinion (PBO) issued by the USFWS. These PBOs contain mandatory terms and conditions to implement the reasonable and prudent measures that are associated with “incidental take” of whichever species or critical habitat is covered by a specific PBO. Authorization under RGP 50 is conditional upon the permittee’s compliance with all the mandatory terms and conditions associated with incidental take of the applicable PBO (or PBOs), which are incorporated by reference in RGP 50. Failure to comply with the terms and conditions associated with incidental take of an applicable PBO, where a take of the federally listed species occurs, would constitute an unauthorized take by the permittee, and would also constitute permittee non-compliance with the authorization under RGP 50. If the terms and conditions of a specific PBO (or PBOs) apply to a project, the Corps will include this/these requirements in any RGP 50 verification that may be issued for a project. The USFWS is the appropriate authority to determine compliance with the terms and conditions of its PBO, and with the ESA.

s. Northern long-eared bat (NLEB) (*Myotis septentrionalis*). Standard Local Operating Procedures for Endangered Species (SLOPES) for the NLEB have been approved by the Corps and the U.S. Fish and Wildlife Service. See <http://www.saw.usace.army.mil/Missions/Regulatory-Permit-Program/Agency-Coordination/ESA/>. This SLOPES details how the Corps will make determinations of effect to the NLEB when the Corps is the lead federal agency for an NCDOT project that is located in the western 41 counties of North Carolina. This SLOPES does not address NCDOT projects (either federal or state funded) in the eastern 59 counties in North Carolina. Note that if another federal agency is the lead federal agency for a project in the western 41 counties, procedures for satisfying the requirements of Section 7(a)(2) of the ESA will be dictated by that agency and will not be applicable for consideration under the SLOPES; however, information that demonstrates the lead federal agency's (if other than the Corps) compliance with Section 7(a)(2) / 4(d) Rule for the NLEB, will be required in the PCN. Note that at the time of issuance of RGP 50, the federal listing status of the NLEB as "Threatened" is being litigated at the National level. If, as a result of litigation, the NLEB is federally listed as "Endangered", this general condition ("s") will no longer be applicable because the 4(d) Rule, and this NLEB SLOPES, will no longer apply/be valid.

t. For proposed activities the sixteen (16) counties listed below, prospective permittees must provide a copy of the PCN to the USFWS, 160 Zillicoa Street, Asheville, North Carolina 28801. This PCN must be sent concurrently to the USFWS and the Corps Project Manager for that specific county.

The 16 counties with tributaries that drain to designated critical habitat that require notification to the Asheville USFWS are: Avery, Cherokee, Forsyth, Graham, Haywood, Henderson, Jackson, Macon Mecklenburg, Mitchell, Stokes, Surry, Swain, Transylvania, Union and Yancey.

u. If the permittee discovers or observes any live, damaged, injured or dead individual of an endangered or threatened species during construction, the permittee shall immediately notify the Wilmington District Engineer so that required coordination can be initiated with the U.S. Fish and Wildlife Service and/or National Marine Fisheries Service.

v. Historic Properties.

(1) In cases where the District Engineer determines that the activity may have the potential to cause effects to properties listed, or eligible for listing, in the National Register of Historic Places (NRHP), the activity is not authorized, until the requirements of Section 106 of the National Historic Preservation Act (NHPA) have been satisfied.

(2) Federal prospective permittees (or when FHWA is the lead federal agency) should follow their own procedures for complying with the requirements of Section 106 of the NHPA. Federal prospective permittees must provide the District Engineer with the appropriate documentation to demonstrate compliance with those requirements; this includes copies of correspondence sent to all interested, federally recognized tribes and a summary statement about

tribal consultation efforts or, if the Corps enters into a Programmatic Agreement (PA) with the FHWA/NCDOT, documentation that the FHWA/NCDOT has complied with PA requirements. The District Engineer will review the documentation and determine whether it is sufficient to address Section 106 compliance for this RGP activity, or whether additional Section 106 consultation is necessary.

(3) Non-federal prospective permittees - the PCN must state which historic properties may be affected by the proposed work or include a vicinity map indicating the location of the historic properties or the potential for the presence of historic properties. Assistance regarding information on the location of or potential for the presence of historic resources can be sought from the State Historic Preservation Officer (SHPO) and/or Tribal Historic Preservation Officer (THPO), as appropriate, and the NRHP (see 33 CFR 330.4(g)). When reviewing PCNs, the District Engineer will comply with the current procedures for addressing the requirements of Section 106 of the NHPA. The District Engineer shall make a reasonable and good faith effort to carry out appropriate identification efforts, which may include background research, consultation, oral history interviews, sample field investigation, and field survey. Based on the information submitted and these efforts, the District Engineer shall determine whether the proposed activity has the potential to cause an effect on the historic properties.

(4) Section 106 consultation is not required when the Corps determines that the activity does not have the potential to cause effects on historic properties (see 36 CFR §800.3(a)).

(5) Section 110k of the NHPA (16 U.S.C. 470h-2(k)) prevents the Corps from granting a permit or other assistance to a prospective permittee who, with intent to avoid the requirements of Section 106 of the NHPA, has intentionally significantly adversely affected a historic property to which the permit will relate, or having legal power to prevent it, allowed such significant adverse effect to occur, unless the Corps, after consultation with the Advisory Council on Historic Preservation (ACHP), determines that circumstances justify granting such assistance despite the adverse effect created or permitted by the prospective permittee. If circumstances justify granting the assistance, the Corps is required to notify the ACHP and provide documentation specifying the circumstances, the degree of damage to the integrity of any historic properties affected, and proposed mitigation. This documentation must include any views obtained from the prospective permittee, SHPO/THPO, appropriate Indian tribes if the undertaking occurs on or affects historic properties on tribal lands or affects properties of interest to those tribes, and other parties known to have a legitimate interest in the impacts to the permitted activity on historic properties.

w. If you discover any previously unknown historic or archeological remains while accomplishing the activity authorized by this general permit, you must immediately notify this office of what you have found. We will initiate the Federal and state coordination required to determine if the remains warrant a recovery effort or if the site is eligible for listing in the National Register of Historic Places.

x. Permittees are advised that development activities in or near a floodway may be subject to the National Flood Insurance Program that prohibits any development, including fill, within a floodway that results in any increase in base flood elevations. This general permit does not authorize any activity prohibited by the National Flood Insurance Program.

y. The permittee must install and maintain, at his/her expense, any signal lights and signals prescribed by the U.S. Coast Guard, through regulations or otherwise, on authorized facilities. For further information, the permittee should contact Coast Guard Sector North Carolina at (910) 772-2191 or email Coast Guard Fifth District at cgd5waterways@uscg.mil.

z. The permittee must maintain any structure or work authorized by this general permit in good condition and in conformance with the terms and conditions of this general permit. The permittee is not relieved of this requirement if the permittee abandons the structure or work. Transfer in fee simple of the work authorized by this general permit will automatically transfer this general permit to the property's new owner, with all of the rights and responsibilities enumerated herein. The permittee must inform any subsequent owner of all activities undertaken under the authority of this general permit and provide the subsequent owner with a copy of the terms and conditions of this general permit.

aa. At his or her sole discretion, any time during the processing cycle, the Wilmington District Engineer may determine that this general permit will not be applicable to a specific proposal. In such case, the procedures for processing an individual permit in accordance with 33 CFR 325 will be available.

bb. Except as authorized by this general permit or any Corps approved modification to this general permit, all fill material placed in waters or wetlands shall be generated from an upland source and will be clean and free of any pollutants except in trace quantities. Metal products, organic materials (including debris from land clearing activities), or unsightly debris will not be used.

cc. Except as authorized by this general permit or any Corps approved modification to this general permit, all excavated material will be disposed of in approved upland disposal areas.

dd. Activities which have commenced (i.e., are under construction) or are under contract to commence in reliance upon this general permit will remain authorized provided the activity is completed within twelve months of the date of the general permit's expiration, modification, or revocation. Activities completed under the authorization of this general permit that were in effect at the time the activity was completed continue to be authorized by the general permit.

ee. The permittee is responsible for obtaining any “take” permits required under the USFWS’s regulations governing compliance with the Migratory Bird Treaty Act or the Bald and Golden Eagle Protection Act. The permittee should contact the appropriate local office of the USFWS to determine if such “take” permits are required for a particular activity.

ff. The activity must comply with applicable FEMA approved state or local floodplain management requirements.

gg. There will be no unreasonable interference with navigation or the right of the public to riparian access by the existence or use of activities authorized by this RGP.

hh. Unless authorization to fill those specific wetlands or mudflats has been issued by the Corps, heavy equipment working in wetlands or mudflats must be placed on mats, or other measures must be taken to minimize soil disturbance.

ii. This RGP will not be applicable to proposed construction when the Wilmington District Engineer determines that the proposed activity will significantly affect the quality of the human environment and determines that an EIS must be prepared.

BY AUTHORITY OF THE SECRETARY OF THE ARMY:

CLARK.ROBERT.J
AMES.10189013
03

Digitally signed by
CLARK.ROBERT.JAMES.1018
901303
Date: 2020.05.26 14:50:28
-04'00'

Robert J. Clark
Colonel, U. S. Army
District Commander

ROY COOPER
Governor
ELIZABETH S. BISER
Secretary
RICHARD E. ROGERS, JR.
Director



November 29, 2023

DWR # 20231601
Wayne County

Mr. Keith Eason, PE, Division Engineer
NCDOT Division 4
PO Box 3165
Wilson, NC 27895
dkeason@ncdot.gov

Subject: APPROVAL OF 401 WATER QUALITY CERTIFICATION WITH ADDITIONAL CONDITIONS
NCDOT Project: TIP #U-3609B, US Hwy 13 from SR 1003 to SR 1572, Wayne County.

Dear Mr. Eason:

You have our approval for the impacts listed below for the purpose described in your application received by the Division of Water Resources (Division) on November 22, 2023. These impacts are covered by the attached Water Quality General Certification Number 4135 and the conditions listed below. This certification is associated with the use of Regional General Permit 50 once it is issued to you by the U.S. Army Corps of Engineers. Please note that you should get any other federal, state or local permits before proceeding with your project, including those required by (but not limited to) Sediment and Erosion Control, Non-Discharge, and Water Supply Watershed regulations.

The Division has determined that the proposed project will comply with water quality requirements provided that you adhere to the conditions listed in the enclosed certification and the additional conditions below.

The following proposed impacts are hereby approved. No other impacts are approved, including incidental impacts. [15A NCAC 02H .0506(b)]

Stream Impacts in the Neuse River Basin

Site	Permanent Fill in Intermittent Stream (linear ft)	Temporary Impact to Intermittent Stream (linear ft)	Permanent Fill in Perennial Stream (linear ft)	Temporary Impact to Perennial Stream (linear ft)	Total Stream Impact (linear ft)
1	0	0	160	115	275
2	94	21	0	0	115
3	106	5	0	0	111
Total	200	26	160	115	501

Total Stream Impact for Project: 501 linear feet.



Wetland Impacts in the Neuse River Basin

Site 1	Permanent Fill (ac)	Excavation (ac)	Mechanized Clearing (ac)	Hand Clearing (ac)	Total Wetland Impact (ac)
Total	0.35	0.02	0.13	0.18	0.68

Total Wetland Impact for Project: 0.68 acres.

This approval is for the purpose and design described in your application. The plans and specifications for this project are incorporated by reference as part of this Certification. If you change your project, you must notify the Division and you may be required to submit a new application package with the appropriate fee. If the property is sold, the new owner must be given a copy of this Certification and is responsible for complying with all conditions. [15A NCAC 02H .0507(d)(2)].

If you are unable to comply with any of the conditions of the attached Water Quality General Certification or with the additional conditions below, you must notify the NCDWR Transportation Permitting Branch within 24 hours (or the next business day if a weekend or holiday) from the time the permittee becomes aware of the circumstances.

The permittee shall report to the NC Division of Water Resources any noncompliance with, and/or any violation of, stream or wetland standards [15A NCAC 02B .0200] including but not limited to sediment impacts to streams or wetlands. Information shall be provided orally within 24 hours (or the next business day if a weekend or holiday) from the time the permittee became aware of the non-compliance circumstances.

Additional Conditions:

1. Compensatory mitigation for impacts to 0.5 acres of riparian wetlands is required. We understand that you have chosen to perform compensatory mitigation for impacts to wetlands through the North Carolina Division of Mitigation Services (DMS), and that the DMS has agreed to implement the mitigation for the project. DMS has indicated in a letter dated September 1, 2023 that they will assume responsibility for satisfying the federal Clean Water Act compensatory mitigation requirements for the above-referenced project, in accordance with DMS's Mitigation Banking Instrument signed July 28, 2010.

2. Unless otherwise approved in this certification, placement of culverts and other structures in open waters and streams, shall be placed below the elevation of the streambed by one foot for all culverts with a diameter greater than 48 inches, and 20 percent of the culvert diameter for culverts having a diameter less than 48 inches, to allow low flow passage of water and aquatic life. Design and placement of culverts and other structures including temporary erosion control measures shall not be conducted in a manner that may result in dis-equilibrium of wetlands or streambeds or banks, adjacent to or upstream and down stream of the above structures. The applicant is required to provide evidence that the equilibrium is being maintained if requested in writing by the NCDWR. If this condition is unable to be met due to bedrock or other limiting features encountered during construction, please contact the NCDWR for guidance on how to proceed and to determine whether or not a permit modification will be required. [15A NCAC 02H.0506(b)(2)]



3. If multiple pipes or barrels are required, they shall be designed to mimic natural stream cross section as closely as possible including pipes or barrels at flood plain elevation and/or sills where appropriate. Widening the stream channel should be avoided. Stream channel widening at the inlet or outlet end of structures typically decreases water velocity causing sediment deposition that requires increased maintenance and disrupts aquatic life passage. [15A NCAC 02H.0506(b)(2)]

4. Riprap shall not be placed in the active thalweg channel or placed in the streambed in a manner that precludes aquatic life passage. Bioengineering boulders or structures should be properly designed, sized and installed. [15A NCAC 02H.0506(b)(2)]

5. The stream channel shall be excavated no deeper than the natural bed material of the stream, to the maximum extent practicable. Efforts must be made to minimize impacts to the stream banks, as well as to vegetation responsible for maintaining the stream bank stability. Any applicable riparian buffer impact for access to stream channel shall be temporary and be revegetated with native riparian species. [15A NCAC 02H.0506(b)(2)]

6. Wetland areas impacted by temporary clearing shall be stabilized and reseeded with native wetland seed. [15A NCAC 2H.0506(b)]

7. DWR approves the stormwater drainage design as shown in the 401 application, under the assumption that it meets the requirements of the NCDOT NPDES permit #NCS000250. These plans are enforceable by DWR. Changes to the approved plans are prohibited without prior approval from DWR. If sediment or other pollutants are found to be discharged from the stormwater outfalls, DWR may take enforcement action. NCDOT and DWR shall assess the damage to water quality standards and implement an appropriate action plan to address the impacts. The action plan shall provide an appropriate timeline for implementation as agreed upon by both DWR and NCDOT. This may require NCDOT to obtain a modification to its current 401 and 404 permits.

8. If concrete is used during construction, a dry work area shall be maintained to prevent direct contact between curing concrete and stream water. Water that inadvertently contacts uncured concrete shall not be discharged to surface waters due to the potential for elevated pH and possible aquatic life and fish kills. [15A NCAC 02B.0200]

9. For all streams being impacted due to site dewatering activities, the site shall be graded to its preconstruction contours and revegetated with appropriate native species. [15A NCAC 02H.0506(b)(2)]

10. During the construction of the project, no staging of equipment of any kind is permitted in waters of the U.S., or protected riparian buffers. [15A NCAC 02H.0506(b)(2)]

11. The dimension, pattern and profile of the stream above and below the crossing shall not be modified. Disturbed floodplains and streams shall be restored to natural geomorphic conditions. [15A NCAC 02H.0506(b)(2)]

12. The use of rip-rap above the Normal High Water Mark shall be minimized. Any rip-rap placed for stream stabilization shall be placed in stream channels in such a manner that it does not impede aquatic life passage. [15A NCAC 02H.0506(b)(2)]



13. The Permittee shall ensure that the final design drawings adhere to the permit and to the permit drawings submitted for approval. [15A NCAC 02H .0507 (c) and 15A NCAC 02H .0506 (b)(2) and (c)(2)]
14. All work in or adjacent to stream waters shall be conducted in a dry work area. Approved BMP measures from the most current version of NCDOT Construction and Maintenance Activities manual such as sandbags, rock berms, cofferdams and other diversion structures shall be used to prevent excavation in flowing water. [15A NCAC 02H.0506(b)(3) and (c)(3)]
15. Heavy equipment shall be operated from the banks rather than in the stream channel in order to minimize sedimentation and reduce the introduction of other pollutants into the stream. [15A NCAC 02H.0506(b)(3)]
16. All mechanized equipment operated near surface waters must be regularly inspected and maintained to prevent contamination of stream waters from fuels, lubricants, hydraulic fluids, or other toxic materials. [15A NCAC 02H.0506(b)(3)]
17. No rock, sand or other materials shall be dredged from the stream channel except where authorized by this certification. [15A NCAC 02H.0506(b)(3)]
18. Discharging hydroseed mixtures and washing out hydroseeders and other equipment in or adjacent to surface waters is prohibited. [15A NCAC 02H.0506(b)(3)]
19. The permittee and its authorized agents shall conduct its activities in a manner consistent with State water quality standards (including any requirements resulting from compliance with §303(d) of the Clean Water Act) and any other appropriate requirements of State and Federal law. If the NCDWR determines that such standards or laws are not being met (including the failure to sustain a designated or achieved use) or that State or federal law is being violated, or that further conditions are necessary to assure compliance, the NCDWR may reevaluate and modify this certification. [15A NCAC 02B.0200]
20. All fill slopes located in jurisdictional wetlands shall be placed at slopes no flatter than 3:1, unless otherwise authorized by this certification. [15A NCAC 02H.0506(b)(2)]
21. A copy of this Water Quality Certification shall be maintained on the construction site at all times. In addition, the Water Quality Certification and all subsequent modifications, if any, shall be maintained with the Division Engineer and the on-site project manager. [15A NCAC 02H .0507(c) and 15A NCAC 02H .0506 (b)(2) and (c)(2)]
22. The outside buffer, wetland or water boundary located within the construction corridor approved by this authorization, including all non-commercial borrow and waste sites associated with the project, shall be clearly marked by highly visible fencing prior to any land disturbing activities. Impacts to areas within the fencing are prohibited unless otherwise authorized by this certification. [15A NCAC 02H.0501 and .0502]
21. The issuance of this certification does not exempt the Permittee from complying with any and all statutes, rules, regulations, or ordinances that may be imposed by other government agencies (i.e. local, state, and federal) having jurisdiction, including but not limited to applicable buffer rules, stormwater management rules, soil erosion and sedimentation control requirements, etc.



22. The Permittee shall report any violations of this certification to the Division of Water Resources within 24 hours of discovery. [15A NCAC 02B.0506(b)(2)]

23. Upon completion of the project (including any impacts at associated borrow or waste sites), the NCDOT Division Engineer shall complete and return the enclosed "Certification of Completion Form" to notify the NCDWR when all work included in the 401 Certification has been completed. [15A NCAC 02H.0502(f)]

24. There shall be no excavation from, or waste disposal into, jurisdictional wetlands or waters associated with this permit without appropriate modification. Should waste or borrow sites, or access roads to waste or borrow sites, be located in wetlands or streams, compensatory mitigation will be required since that is a direct impact from road construction activities. [15A NCAC 02H.0506(b)(3) and (c)(3)]

25. Erosion and sediment control practices must be in full compliance with all specifications governing the proper design, installation and operation and maintenance of such Best Management Practices in order to protect surface waters standards [15A NCAC 02H.0506(b)(3) and (c)(3)]:

- a. The erosion and sediment control measures for the project must be designed, installed, operated, and maintained in accordance with the most recent version of the *North Carolina Sediment and Erosion Control Planning and Design Manual*.
- b. The design, installation, operation, and maintenance of the sediment and erosion control measures must be such that they equal, or exceed, the requirements specified in the most recent version of the *North Carolina Sediment and Erosion Control Manual*. The devices shall be maintained on all construction sites, borrow sites, and waste pile (spoil) projects, including contractor-owned or leased borrow pits associated with the project.
- c. For borrow pit sites, the erosion and sediment control measures must be designed, installed, operated, and maintained in accordance with the most recent version of the *North Carolina Surface Mining Manual*.
- d. The reclamation measures and implementation must comply with the reclamation in accordance with the requirements of the Sedimentation Pollution Control Act.

26. Design, installation, operation, and maintenance of all sediment and erosion control measures shall be equal to or exceed the requirements specified in the most recent version of the *North Carolina Sediment and Erosion Control Manual*, or for linear transportation projects, the *NCDOT Sediment and Erosion Control Manual*.

All devices shall be maintained on all construction sites, borrow sites, and waste pile (spoil) sites, including contractor-owned or leased borrow pits associated with the project. Sufficient materials required for stabilization and/or repair of erosion control measures and stormwater routing and treatment shall be on site at all times.

For borrow pit sites, the erosion and sediment control measures shall be designed, installed, operated, and maintained in accordance with the most recent version of the *North Carolina Surface Mining Manual*. Reclamation measures and implementation shall comply with the reclamation in accordance with the requirements of the Sedimentation Pollution Control Act and the Mining Act of 1971. [15A NCAC 02H.0506(b)(3) and (c)(3); GC 4135]

27. Sediment and erosion control measures shall not be placed in wetlands or surface waters, or within 5 feet of the top of bank, without prior approval from DWR. [15A NCAC 02H.0506(b)(3) and (c)(3)]



28. When applicable, all construction activities shall be performed and maintained in full compliance with G.S. Chapter 113A Article 4 (Sediment and Pollution Control Act of 1973). Regardless of applicability of the Sediment and Pollution Control Act, all projects shall incorporate appropriate Best Management Practices for the control of sediment and erosion so that no violations of state water quality standards, statutes, or rules occur. [15A NCAC 02H .0506(b)(3) and (c)(3) and 15A NCAC 02B .0200]

This approval and its conditions are final and binding unless contested [G.S. 143-215.5]. Please be aware that impacting waters without first applying for and securing the issuance of a 401 Water Quality Certification violates Title 15A of the North Carolina Administrative Code (NCAC) 2H .0500. Title 15A NCAC 2H .0500 requires certifications pursuant to Section 401 of the Clean Water Act whenever construction or operation of facilities will result in a discharge into navigable waters, including wetlands, as described in 33 Code of Federal Regulations (CFR) Part 323. It also states any person desiring issuance of the State certification or coverage under a general certification required by Section 401 of the Federal Water Pollution Control Act shall file with the Director of the North Carolina Division of Water Quality. Pursuant to G.S. 143-215.6A, these violations and any future violations are subject to a civil penalty assessment of up to a maximum of \$25,000.00 per day for each violation.

This Certification can be contested as provided in Chapter 150B of the North Carolina General Statutes by filing a Petition for a Contested Case Hearing (Petition) with the North Carolina Office of Administrative Hearings (OAH) within sixty (60) calendar days. Requirements for filing a Petition are set forth in Chapter 150B of the North Carolina General Statutes and Title 26 of the North Carolina Administrative Code. Additional information regarding requirements for filing a Petition and Petition forms may be accessed at <http://www.ncoah.com/> or by calling the OAH Clerk's Office at (919) 431-3000.

A party filing a Petition must serve a copy of the Petition on:

William F. Lane, General Counsel
Department of Environmental Quality
1601 Mail Service Center
Raleigh, NC 27699-1601

If the party filing the Petition is not the permittee, then the party must also serve the recipient of the Certification in accordance with N.C.G.S 150B-23(a).

This letter completes the review of the Division under section 401 of the Clean Water Act and 15A NCAC 02H .0500. Please contact Rob Ridings at rob.ridings@deq.nc.gov or 919-707-8786 if you have any questions or concerns.

Sincerely,
DocuSigned by:

4F4DD2F21EA846E...

Richard E. Rogers Jr, Director
Division of Water Resources

Cc: Kyle Barnes, USACE Washington Regulatory Field Office (kyle.w.barnes@usace.army.mil)
Garry Wright, Division 4 Environmental Officer (glwright@ncdot.gov)
Beth Harmon, Division of Mitigation Services (beth.harmon@ncdenr.gov)
File Copy



ROY COOPER
 Governor
 ELIZABETH S. BISER
 Secretary
 RICHARD E. ROGERS, JR.
 Director



November 29, 2023

DWR # 20231601
 Wayne County

Mr. Keith Eason, PE, Division Engineer
 NCDOT Division 4
 PO Box 3165
 Wilson, NC 27895
 dkeason@ncdot.gov

Subject: APPROVAL of NEUSE RIPARIAN BUFFER IMPACTS WITH ADDITIONAL CONDITIONS
 NCDOT Project: TIP #U-3609B, US Hwy 13 from SR 1003 to SR 1572, Wayne County.

Dear Mr. Eason:

You have our approval for the impacts listed below for the purpose described in your application received by the Division of Water Resources (Division) on November 22, 2023. These impacts are covered by the Neuse Buffer Rules and the conditions listed below. Please note that you should get any other federal, state or local permits before proceeding with your project, including those required by (but not limited to) Sediment and Erosion Control, Non-Discharge, and Water Supply Watershed regulations.

The following impacts are hereby approved, provided that all of the Conditions listed below and all of the conditions of the Jordan Buffer Rules are met. No other impacts are approved, including incidental impacts. [15A NCAC 02B.0611(b)(2)]

Neuse Riparian Buffer Impacts

Site	Zone 1 Impact (sq ft)	minus Wetlands in Zone 1 (sq ft)	= Zone 1 Buffers (not wetlands) (sq ft)	Zone 1 Buffer Mitigation Required (using 3:1 ratio)	Zone 2 Impact (sq ft)	minus Wetlands in Zone 2 (sq ft)	= Zone 2 Buffers (not wetlands) (sq ft)	Zone 2 Buffer Mitigation Required (using 1.5:1 ratio)
1	10408	8062	2346	7038	5021	3230	1791	2687
2	5378	0	5378	N/A	3350	0	3350	N/A
3	6192	0	6192	N/A	3828	0	3828	N/A
Totals	21978	8062	13916	7038	12199	3230	8969	2687

* n/a = Total for Site is less than 1/3 acre: No mitigation required
Total Buffer Impact for Project: 34177 square feet.



This approval is for the purpose and design described in your application. The plans and specifications for this project are incorporated by reference as part of this Authorization Certificate. If you change your project, you must notify the Division and you may be required to submit a new application package. If the property is sold, the new owner must be given a copy of this Authorization Certificate and is responsible for complying with all conditions. [15A NCAC 02B.0611(b)(2)] If you are unable to comply with any of the conditions below, you must notify the DWR Transportation Permitting Branch within 24 hours (or the next business day if a weekend or holiday) from the time the permittee becomes aware of the circumstances.

The permittee shall report to the NC Division of Water Resources any noncompliance with the conditions of this Authorization Certificate and/or any violation of state regulated riparian buffer rules [15A NCAC 2B.0714] Information shall be provided orally within 24 hours (or the next business day if a weekend or holiday) from the time the applicant became aware of the circumstances.

Conditions of Approval:

1. Compensatory mitigation for impacts to 2346 square feet of protected riparian buffers in Zone 1 and 1791 square feet of protected riparian buffers in Zone 2 shall be required. This total mitigated shall be 9725 square feet. We understand that you have chosen to perform compensatory mitigation for impacts to protected buffers through use of the North Carolina Division of Mitigation Services (DMS). Mitigation for unavoidable impacts to Neuse Riparian Buffers shall be provided in the Neuse River Basin and done in accordance with 15A NCAC 2B.0295. The DMS has indicated in a letter dated September 1, 2023 that they will assume responsibility for satisfying the compensatory mitigation requirements for the above-referenced project, in accordance with DMS's Mitigation Banking Instrument signed June 14, 2016.

2. All riparian buffers impacted by the placement of temporary fill or clearing activities shall be restored to the preconstruction contours and revegetated. Maintained buffers shall be permanently revegetated with non-woody species by the end of the growing season following completion of construction. For the purpose of this condition, maintained buffer areas are defined as areas within the transportation corridor that will be subject to regular NCDOT maintenance activities including mowing. The area with non-maintained buffers shall be permanently revegetated with native woody species before the next growing season following completion of construction. [15A NCAC 02B.0714]

3. Pursuant to 15A NCAC 2B.0714, sediment and erosion control devices shall not be placed in Zone 1 of any Neuse Buffer without prior approval by the NCDWR. At this time, the NCDWR has approved no sediment and erosion control devices in Zone 1, outside of the approved project impacts, anywhere on this project. Moreover, sediment and erosion control devices shall be allowed in Zone 2 of the buffers provided that Zone 1 is not compromised and that discharge is released as diffuse flow.

4. All stormwater runoff shall be directed as sheetflow through stream buffers at non-erosive velocities, unless otherwise approved by this certification. [15A NCAC 02B.0714]

5. Native riparian vegetation (i.e., trees and shrubs native to your geographic region) must be reestablished in the riparian areas within the construction limits of the project by the end of the growing season following completion of construction. [15A NCAC 02B.0714] & [15A NCAC 02B.0506(b)(2)]



P-35

DocuSign Envelope ID: D39066B8-74E3-4CF1-8EB6-9789A4FF24C9

This approval and its conditions are final and binding unless contested. [G.S. 143-215.5]
This Authorization Certificate can be contested as provided in Chapter 150B of the North Carolina General Statutes by filing a Petition for a Contested Case Hearing (Petition) with the North Carolina Office of Administrative Hearings (OAH) **within sixty (60) calendar days**. Requirements for filing a Petition are set forth in Chapter 150B of the North Carolina General Statutes and Title 26 of the North Carolina Administrative Code. Additional information regarding requirements for filing a Petition and Petition forms may be accessed at <http://www.ncoah.com/> or by calling the OAH Clerk's Office at (919) 431-3000. One (1) copy of the Petition must also be served to the North Carolina Department of Environmental Quality:

William F. Lane, General Counsel
Department of Environmental Quality
1601 Mail Service Center
Raleigh, NC 27699-1601

This Authorization shall expire five (5) years from the date of this letter.

This letter completes the review of the Division under the Neuse Riparian Buffer Rules as described in 15A NCAC 02B.0714. Please contact Rob Ridings at rob.ridings@deq.nc.gov or 919-707-8786 if you have any questions or concerns.

Sincerely,

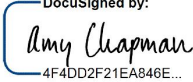
DocuSigned by:

4F4DD2F21EA846E...

Richard E. Rogers, Jr., Director
Division of Water Resources

Cc: Kyle Barnes, USACE Washington Regulatory Field Office (kyle.w.barnes@usace.army.mil)
Garry Wright, Division 4 Environmental Officer (glwright@ncdot.gov)
Beth Harmon, Division of Mitigation Services (beth.harmon@ncdenr.gov)
File Copy



North Carolina Department of Environmental Quality | Division of Water Resources
512 North Salisbury Street | 1611 Mail Service Center | Raleigh, North Carolina 27699-1611
919.707.9000

STATE OF NORTH CAROLINA
DEPARTMENT OF ENVIRONMENTAL QUALITY
DIVISION OF WATER RESOURCES

WATER QUALITY GENERAL CERTIFICATION NO. 4135

GENERAL CERTIFICATION FOR PROJECTS ELIGIBLE FOR US ARMY CORPS OF ENGINEERS

- **NATIONWIDE PERMIT NUMBER 14 (LINEAR TRANSPORTATION PROJECTS), AND**
- **REGIONAL GENERAL PERMIT 198200031 (NCDOT BRIDGES, WIDENING PROJECTS, INTERCHANGE IMPROVEMENTS)**

Water Quality Certification Number 4135 is issued in conformity with the requirements of Section 401, Public Laws 92-500 and 95-217 of the United States and subject to the North Carolina Regulations in 15A NCAC 02H .0500 and 15A NCAC 02B .0200 for the discharge of fill material to surface waters and wetland areas as described in 33 CFR 330 Appendix A (B) (14) of the US Army Corps of Engineers regulations and Regional General Permit 198200031.

The State of North Carolina certifies that the specified category of activity will not violate applicable portions of Sections 301, 302, 303, 306 and 307 of the Public Laws 92-500 and 95-217 if conducted in accordance with the conditions hereinafter set forth.

Effective date: December 1, 2017

Signed this day: December 1, 2017

By



for Linda Culpepper
Interim Director

GC4135

Activities meeting any one (1) of the following thresholds or circumstances require written approval for a 401 Water Quality Certification from the Division of Water Resources (DWR):

- a) If any of the conditions of this Certification (listed below) cannot be met; or
- b) Any temporary or permanent impacts to wetlands, open waters and/or streams, except for construction of a driveway to a single family residential lot that is determined to not be part of a larger common plan of development, as long as the driveway involves a travel lane of less than 25 feet and total stream impacts of less than 60 feet, including any topographic/slope stabilization or in-stream stabilization needed for the crossing; or
- c) Any stream relocation or stream restoration; or
- d) Any high-density project, as defined in 15A NCAC 02H .1003(2)(a) and by the density thresholds specified in 15A NCAC 02H .1017, which:
 - i. Disturbs one acre or more of land (including a project that disturbs less than one acre of land that is part of a larger common plan of development or sale); and
 - ii. Has permanent wetland, stream or open water impacts; and
 - iii. Is proposing new built-upon area; and
 - iv. Does not have a stormwater management plan reviewed and approved under a state stormwater program¹ or a state-approved local government stormwater program².

Projects that have vested rights, exemptions, or grandfathering from state or locally-implemented stormwater programs and projects that satisfy state or locally-implemented stormwater programs through use of community in-lieu programs **require written approval**; or

- e) Any permanent impacts to waters, or to wetlands adjacent to waters, designated as: ORW (including SAV), HQW (including PNA), SA, WS-I, WS-II, or North Carolina or National Wild and Scenic River.
- f) Any permanent impacts to waters, or to wetlands adjacent to waters, designated as Trout except for driveway projects that are below threshold (b) above provided that:
 - i. The impacts are not adjacent to any existing structures
 - ii. All conditions of this General Certification can be met, including adherence to any moratoriums as stated in Condition #10; and
 - iii. A *Notification of Work in Trout Watersheds Form* is submitted to the Division at least 60 days prior to commencement of work; or
- g) Any permanent impacts to coastal wetlands [15A NCAC 07H .0205], or Unique Wetlands (UWL); or
- h) Any impact associated with a Notice of Violation or an enforcement action for violation(s) of NC Wetland Rules (15A NCAC 02H .0500), NC Isolated Wetland Rules (15A NCAC 02H .1300), NC Surface Water or Wetland Standards (15A NCAC 02B .0200), or State Regulated Riparian Buffer Rules (15A NCAC 02B .0200); or

¹ e.g. Coastal Counties, HQW, ORW, or state-implemented Phase II NPDES

² e.g. Delegated Phase II NPDES, Water Supply Watershed, Nutrient-Sensitive Waters, or Universal Stormwater Management Program

GC4135

- i) Any impacts to subject water bodies and/or state regulated riparian buffers along subject water bodies in the Neuse, Tar-Pamlico, or Catawba River Basins or in the Randleman Lake, Jordan Lake or Goose Creek Watersheds (or any other basin or watershed with State Regulated Riparian Area Protection Rules [Buffer Rules] in effect at the time of application) *unless*:
 - i. The activities are listed as “EXEMPT” from these rules; or
 - ii. A Buffer Authorization Certificate is issued by the NC Division of Coastal Management (DCM); or
 - iii. A Buffer Authorization Certificate or a Minor Variance is issued by a delegated or designated local government implementing a state riparian buffer program pursuant to 143-215.23

Activities included in this General Certification that do not meet one of the thresholds listed above do not require written approval.

I. ACTIVITY SPECIFIC CONDITIONS:

- 1. If this Water Quality Certification is used to access residential, commercial or industrial building sites, then all parcels owned by the applicant that are part of the single and complete project authorized by this Certification must be buildable without additional impacts to streams or wetlands. If required in writing by DWR, the applicant shall provide evidence that the parcels are buildable without requiring additional impacts to wetlands, waters, or state regulated riparian buffers. [15A NCAC 02H .0506(b)(4) and (c)(4)]
- 2. For road and driveway construction purposes, this Certification shall only be utilized from natural high ground to natural high ground. [15A NCAC 02H .0506(b)(2) and (c)(2)]
- 3. Deed notifications or similar mechanisms shall be placed on all lots with retained jurisdictional wetlands, waters, and state regulated riparian buffers within the project boundaries in order to assure compliance with NC Wetland Rules (15A NCAC 02H .0500), NC Isolated Wetland Rules (15A NCAC 02H .1300), and/or State Regulated Riparian Buffer Rules (15A NCAC 02B .0200). These mechanisms shall be put in place at the time of recording of the property or individual parcels, whichever is appropriate. [15A NCAC 02H .0506(b)(4) and (c)(4)]
- 4. For the North Carolina Department of Transportation, compliance with the NCDOT’s individual NPDES permit NCS000250 shall serve to satisfy this condition. All other high-density projects that trigger threshold item (d) above shall comply with one of the following requirements: [15A NCAC 02H .0506(b)(5) and (c)(5)]

GC4135

- a. Provide a completed Stormwater Management Plan (SMP) for review and approval, including all appropriate stormwater control measure (SCM) supplemental forms and associated items, that complies with the high-density development requirements of 15A NCAC 02H .1003. Stormwater management shall be provided throughout the entire project area in accordance with 15A NCAC 02H .1003. For the purposes of 15A NCAC 02H .1003(2)(a), density thresholds shall be determined in accordance with 15A NCAC 02H .1017.
- b. Provide documentation (including calculations, photos, etc.) that the project will not cause degradation of downstream surface waters. Documentation shall include a detailed analysis of the hydrological impacts from stormwater runoff when considering the volume and velocity of stormwater runoff from the project built upon area and the size and existing condition of the receiving stream(s).

Exceptions to this condition require application to and written approval from DWR.

II. GENERAL CONDITIONS:

1. When written authorization is required, the plans and specifications for the project are incorporated into the authorization by reference and are an enforceable part of the Certification. Any modifications to the project require notification to DWR and may require an application submittal to DWR with the appropriate fee. [15A NCAC 02H .0501 and .0502]
2. No waste, spoil, solids, or fill of any kind shall occur in wetlands or waters beyond the footprint of the impacts (including temporary impacts) as authorized in the written approval from DWR; or beyond the thresholds established for use of this Certification without written authorization. [15A NCAC 02H .0501 and .0502]

No removal of vegetation or other impacts of any kind shall occur to state regulated riparian buffers beyond the footprint of impacts approved in a Buffer Authorization or Variance or as listed as an exempt activity in the applicable riparian buffer rules. [15A NCAC 02B .0200]

3. In accordance with 15A NCAC 02H .0506(h) and Session Law 2017-10, compensatory mitigation may be required for losses of greater than 300 linear feet of perennial streams and/or greater than one (1) acre of wetlands. Impacts associated with the removal of a dam shall not require mitigation when the removal complies with the requirements of Part 3 of Article 21 in Chapter 143 of the North Carolina General Statutes. Impacts to isolated and other non-404 jurisdictional wetlands shall not be combined with 404 jurisdictional wetlands for the purpose of determining when impact thresholds trigger a mitigation requirement. For linear publicly owned and maintained transportation projects that are not determined to be part of a larger common plan of development by the US Army Corps of Engineers, compensatory mitigation may be required for losses of greater than 300 linear feet per perennial stream.

GC4135

Compensatory stream and/or wetland mitigation shall be proposed and completed in compliance with G.S. 143-214.11. For applicants proposing to conduct mitigation within a project site, a complete mitigation proposal developed in accordance with the most recent guidance issued by the US Army Corps of Engineers Wilmington District shall be submitted for review and approval with the application for impacts.

4. All activities shall be in compliance with any applicable State Regulated Riparian Buffer Rules in Chapter 2 of Title 15A.
5. When applicable, all construction activities shall be performed and maintained in full compliance with G.S. Chapter 113A Article 4 (Sediment and Pollution Control Act of 1973). Regardless of applicability of the Sediment and Pollution Control Act, all projects shall incorporate appropriate Best Management Practices for the control of sediment and erosion so that no violations of state water quality standards, statutes, or rules occur. [15A NCAC 02H .0506(b)(3) and (c)(3) and 15A NCAC 02B .0200]

Design, installation, operation, and maintenance of all sediment and erosion control measures shall be equal to or exceed the requirements specified in the most recent version of the *North Carolina Sediment and Erosion Control Manual*, or for linear transportation projects, the *NCDOT Sediment and Erosion Control Manual*.

All devices shall be maintained on all construction sites, borrow sites, and waste pile (spoil) sites, including contractor-owned or leased borrow pits associated with the project. Sufficient materials required for stabilization and/or repair of erosion control measures and stormwater routing and treatment shall be on site at all times.

For borrow pit sites, the erosion and sediment control measures shall be designed, installed, operated, and maintained in accordance with the most recent version of the *North Carolina Surface Mining Manual*. Reclamation measures and implementation shall comply with the reclamation in accordance with the requirements of the Sedimentation Pollution Control Act and the Mining Act of 1971.

If the project occurs in waters or watersheds classified as Primary Nursery Areas (PNAs), SA, WS-I, WS-II, High Quality Waters (HQW), or Outstanding Resource Waters (ORW), then the sedimentation and erosion control designs shall comply with the requirements set forth in 15A NCAC 04B .0124, *Design Standards in Sensitive Watersheds*.

6. Sediment and erosion control measures shall not be placed in wetlands or waters except within the footprint of temporary or permanent impacts authorized under this Certification. Exceptions to this condition require application to and written approval from DWR. [15A NCAC 02H .0501 and .0502]
7. Erosion control matting that incorporates plastic mesh and/or plastic twine shall not be used along streambanks or within wetlands. Exceptions to this condition require application to and written approval from DWR. [15A NCAC 02B .0201]

GC4135

8. An NPDES Construction Stormwater Permit (NCG010000) is required for construction projects that disturb one (1) or more acres of land. The NCG010000 Permit allows stormwater to be discharged during land disturbing construction activities as stipulated in the conditions of the permit. If the project is covered by this permit, full compliance with permit conditions including the erosion & sedimentation control plan, inspections and maintenance, self-monitoring, record keeping and reporting requirements is required. [15A NCAC 02H .0506(b)(5) and (c)(5)]

The North Carolina Department of Transportation (NCDOT) shall be required to be in full compliance with the conditions related to construction activities within the most recent version of their individual NPDES (NCS000250) stormwater permit. [15A NCAC 02H .0506(b)(5) and (c)(5)]

9. All work in or adjacent to streams shall be conducted so that the flowing stream does not come in contact with the disturbed area. Approved best management practices from the most current version of the *NC Sediment and Erosion Control Manual*, or the *NC DOT Construction and Maintenance Activities Manual*, such as sandbags, rock berms, cofferdams, and other diversion structures shall be used to minimize excavation in flowing water. Exceptions to this condition require application to and written approval from DWR. [15A NCAC 02H .0506(b)(3) and (c)(3)]
10. If activities must occur during periods of high biological activity (e.g. sea turtle nesting, fish spawning, or bird nesting), then biological monitoring may be required at the request of other state or federal agencies and coordinated with these activities. [15A NCAC 02H .0506(b)(2) and 15A NCAC 04B .0125]

All moratoriums on construction activities established by the NC Wildlife Resources Commission (WRC), US Fish and Wildlife Service (USFWS), NC Division of Marine Fisheries (DMF), or National Marine Fisheries Service (NMFS) shall be implemented. Exceptions to this condition require written approval by the resource agency responsible for the given moratorium. A copy of the approval from the resource agency shall be forwarded to DWR.

Work within a designated trout watershed of North Carolina (as identified by the Wilmington District of the US Army Corps of Engineers), or identified state or federal endangered or threatened species habitat, shall be coordinated with the appropriate WRC, USFWS, NMFS, and/or DMF personnel.

11. Culverts shall be designed and installed in such a manner that the original stream profiles are not altered and allow for aquatic life movement during low flows. The dimension, pattern, and profile of the stream above and below a pipe or culvert shall not be modified by widening the stream channel or by reducing the depth of the stream in connection with the construction activity. The width, height, and gradient of a proposed culvert shall be such as to pass the average historical low flow and spring flow without adversely altering flow velocity. [15A NCAC 02H .0506(b)(2) and (c)(2)]

GC4135

Placement of culverts and other structures in streams shall be below the elevation of the streambed by one foot for all culverts with a diameter greater than 48 inches, and 20% of the culvert diameter for culverts having a diameter less than or equal to 48 inches, to allow low flow passage of water and aquatic life.

If multiple pipes or barrels are required, they shall be designed to mimic the existing stream cross section as closely as possible including pipes or barrels at flood plain elevation and/or sills where appropriate. Widening the stream channel shall be avoided.

When topographic constraints indicate culvert slopes of greater than 5%, culvert burial is not required, provided that all alternative options for flattening the slope have been investigated and aquatic life movement/connectivity has been provided when possible (e.g. rock ladders, cross vanes, etc.). Notification, including supporting documentation to include a location map of the culvert, culvert profile drawings, and slope calculations, shall be provided to DWR 60 calendar days prior to the installation of the culvert.

When bedrock is present in culvert locations, culvert burial is not required provided that there is sufficient documentation of the presence of bedrock. Notification, including supporting documentation such as, a location map of the culvert, geotechnical reports, photographs, etc. shall be provided to DWR a minimum of 60 calendar days prior to the installation of the culvert. If bedrock is discovered during construction, then DWR shall be notified by phone or email within 24 hours of discovery.

If other site-specific topographic constraints preclude the ability to bury the culverts as described above and/or it can be demonstrated that burying the culvert would result in destabilization of the channel, then exceptions to this condition require application to and written approval from DWR.

Installation of culverts in wetlands shall ensure continuity of water movement and be designed to adequately accommodate high water or flood conditions. When roadways, causeways, or other fill projects are constructed across FEMA-designated floodways or wetlands, openings such as culverts or bridges shall be provided to maintain the natural hydrology of the system as well as prevent constriction of the floodway that may result in destabilization of streams or wetlands.

The establishment of native woody vegetation and other soft stream bank stabilization techniques shall be used where practicable instead of rip-rap or other bank hardening methods.

12. Bridge deck drains shall not discharge directly into the stream. Stormwater shall be directed across the bridge and pre-treated through site-appropriate means to the maximum extent practicable (e.g. grassed swales, pre-formed scour holes, vegetated buffers, etc.) before entering the stream. Exceptions to this condition require application to and written approval from DWR. [15A NCAC 02H .0506(b)(5)]

GC4135

13. Application of fertilizer to establish planted/seeded vegetation within disturbed riparian areas and/or wetlands shall be conducted at agronomic rates and shall comply with all other Federal, State and Local regulations. Fertilizer application shall be accomplished in a manner that minimizes the risk of contact between the fertilizer and surface waters. [15A NCAC 02B .0200 and 15A NCAC 02B .0231]
14. If concrete is used during construction, then all necessary measures shall be taken to prevent direct contact between uncured or curing concrete and waters of the state. Water that inadvertently contacts uncured concrete shall not be discharged to waters of the state. [15A NCAC 02B .0200]
15. All proposed and approved temporary fill and culverts shall be removed and the impacted area shall be returned to natural conditions within 60 calendar days after the temporary impact is no longer necessary. The impacted areas shall be restored to original grade, including each stream's original cross sectional dimensions, planform pattern, and longitudinal bed profile. For projects that receive written approval, no temporary impacts are allowed beyond those included in the application and authorization. All temporarily impacted sites shall be restored and stabilized with native vegetation. [15A NCAC 02H .0506(b)(2) and (c)(2)]
16. All proposed and approved temporary pipes/culverts/rip-rap pads etc. in streams shall be installed as outlined in the most recent edition of the *North Carolina Sediment and Erosion Control Planning and Design Manual* or the *North Carolina Surface Mining Manual* or the *North Carolina Department of Transportation Best Management Practices for Construction and Maintenance Activities* so as not to restrict stream flow or cause dis-equilibrium during use of this Certification. [15A NCAC 02H .0506(b)(2) and (c)(2)]
17. Any rip-rap required for proper culvert placement, stream stabilization, or restoration of temporarily disturbed areas shall be restricted to the area directly impacted by the approved construction activity. All rip-rap shall be placed such that the original stream elevation and streambank contours are restored and maintained. Placement of rip-rap or other approved materials shall not result in de-stabilization of the stream bed or banks upstream or downstream of the area or in a manner that precludes aquatic life passage. [15A NCAC 02H .0506(b)(2)]
18. Any rip-rap used for stream or shoreline stabilization shall be of a size and density to prevent movement by wave, current action, or stream flows and shall consist of clean rock or masonry material free of debris or toxic pollutants. Rip-rap shall not be installed in the streambed except in specific areas required for velocity control and to ensure structural integrity of bank stabilization measures. [15A NCAC 02H .0506(b)(2)]
19. Applications for rip-rap groins proposed in accordance with 15A NCAC 07H .1401 (NC Division of Coastal Management General Permit for construction of Wooden and Rip-rap Groins in Estuarine and Public Trust Waters) shall meet all the specific conditions for design and construction specified in 15A NCAC 07H .1405.

GC4135

20. All mechanized equipment operated near surface waters shall be inspected and maintained regularly to prevent contamination of surface waters from fuels, lubricants, hydraulic fluids, or other toxic materials. Construction shall be staged in order to minimize the exposure of equipment to surface waters to the maximum extent practicable. Fueling, lubrication and general equipment maintenance shall be performed in a manner to prevent, to the maximum extent practicable, contamination of surface waters by fuels and oils. [15A NCAC 02H .0506(b)(3) and (c)(3) and 15A NCAC 02B .0211 (12)]
21. Heavy equipment working in wetlands shall be placed on mats or other measures shall be taken to minimize soil disturbance. [15A NCAC 02H .0506(b)(3) and (c)(3)]
22. In accordance with 143-215.85(b), the applicant shall report any petroleum spill of 25 gallons or more; any spill regardless of amount that causes a sheen on surface waters; any petroleum spill regardless of amount occurring within 100 feet of surface waters; and any petroleum spill less than 25 gallons that cannot be cleaned up within 24 hours.
23. If an environmental document is required under the State Environmental Policy Act (SEPA), then this General Certification is not valid until a Finding of No Significant Impact (FONSI) or Record of Decision (ROD) is issued by the State Clearinghouse. If an environmental document is required under the National Environmental Policy Act (NEPA), then this General Certification is not valid until a Categorical Exclusion, the Final Environmental Assessment, or Final Environmental Impact Statement is published by the lead agency. [15A NCAC 01C .0107(a)]
24. This General Certification does not relieve the applicant of the responsibility to obtain all other required Federal, State, or Local approvals before proceeding with the project, including those required by, but not limited to, Sediment and Erosion Control, Non-Discharge, Water Supply Watershed, and Trout Buffer regulations.
25. The applicant and their authorized agents shall conduct all activities in a manner consistent with State water quality standards (including any requirements resulting from compliance with §303(d) of the Clean Water Act), and any other appropriate requirements of State and Federal Law. If DWR determines that such standards or laws are not being met, including failure to sustain a designated or achieved use, or that State or Federal law is being violated, or that further conditions are necessary to assure compliance, then DWR may revoke or modify a written authorization associated with this General Water Quality Certification. [15A NCAC 02H .0507(d)]
26. The permittee shall require its contractors and/or agents to comply with the terms and conditions of this permit in the construction and maintenance of this project, and shall provide each of its contractors and/or agents associated with the construction or maintenance of this project with a copy of this Certification. A copy of this Certification, including all conditions shall be available at the project site during the construction and maintenance of this project. [15A NCAC 02H .0507 (c) and 15A NCAC 02H .0506 (b)(2) and (c)(2)]

GC4135

27. When written authorization is required for use of this Certification, upon completion of all permitted impacts included within the approval and any subsequent modifications, the applicant shall be required to return a certificate of completion (available on the DWR website <https://edocs.deq.nc.gov/Forms/Certificate-of-Completion>). [15A NCAC 02H .0502(f)]
28. Additional site-specific conditions, including monitoring and/or modeling requirements, may be added to the written approval letter for projects proposed under this Water Quality Certification in order to ensure compliance with all applicable water quality and effluent standards. [15A NCAC 02H .0507(c)]
29. If the property or project is sold or transferred, the new permittee shall be given a copy of this Certification (and written authorization if applicable) and is responsible for complying with all conditions. [15A NCAC 02H .0501 and .0502]

III. GENERAL CERTIFICATION ADMINISTRATION:

1. In accordance with North Carolina General Statute 143-215.3D(e), written approval for a 401 Water Quality General Certification must include the appropriate fee. An applicant for a CAMA permit under Article 7 of Chapter 113A of the General Statutes for which a Water Quality Certification is required shall only make one payment to satisfy both agencies; the fee shall be as established by the Secretary in accordance with 143-215.3D(e)(7).
2. This Certification neither grants nor affirms any property right, license, or privilege in any waters, or any right of use in any waters. This Certification does not authorize any person to interfere with the riparian rights, littoral rights, or water use rights of any other person and this Certification does not create any prescriptive right or any right of priority regarding any usage of water. This Certification shall not be interposed as a defense in any action respecting the determination of riparian or littoral rights or other rights to water use. No consumptive user is deemed by virtue of this Certification to possess any prescriptive or other right of priority with respect to any other consumptive user regardless of the quantity of the withdrawal or the date on which the withdrawal was initiated or expanded.
3. This Certification grants permission to the Director, an authorized representative of the Director, or DWR staff, upon the presentation of proper credentials, to enter the property during normal business hours. [15A NCAC 02H .0502(e)]
4. This General Certification shall expire on the same day as the expiration date of the corresponding Nationwide Permit and/or Regional General Permit. The conditions in effect on the date of issuance of Certification for a specific project shall remain in effect for the life of the project, regardless of the expiration date of this Certification. This General Certification is rescinded when the US Army Corps of Engineers reauthorizes any of the corresponding Nationwide Permits and/or Regional General Permits or when deemed appropriate by the Director of the Division of Water Resources.

GC4135

5. Non-compliance with or violation of the conditions herein set forth by a specific project may result in revocation of this General Certification for the project and may also result in criminal and/or civil penalties.
6. The Director of the North Carolina Division of Water Resources may require submission of a formal application for Individual Certification for any project in this category of activity if it is deemed in the public's best interest or determined that the project is likely to have a significant adverse effect upon water quality, including state or federally listed endangered or threatened aquatic species, or degrade the waters so that existing uses of the water or downstream waters are precluded.

History Note: Water Quality Certification (WQC) Number 4135 issued December 1, 2017 replaces WQC Number 4088 issued March 3, 2017; WQC 3886 issued March 12, 2012; WQC Number 3820 issued April 6, 2010; WQC Number 3627 issued March 2007; WQC Number 3404 issued March 2003; WQC Number 3375 issued March 18, 2002; WQC Number 3289 issued June 1, 2000; WQC Number 3103 issued February 11, 1997; WQC Number 2732 issued May 1, 1992; WQC Number 2666 issued January 21, 1992; WQC Number 2177 issued November 5, 1987.

See Sheet 1A For Interchange Details

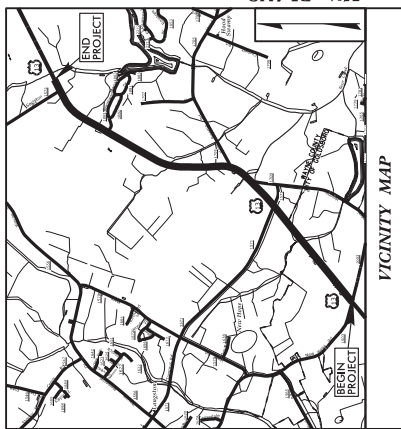

STATE OF NORTH CAROLINA
DIVISION OF HIGHWAYS

WAYNE COUNTY

LOCATION: U.S. 13 (BERKELEY BOULEVARD) FROM
SR 1003 (NEW HOPE ROAD) TO
SR 1572 (SAULSTON ROAD)

TYPE OF WORK: GRADING, PAVING, DRAINAGE
CULVERT & SIGNALS

PERMIT DRAWING
SHEET 1 OF 14

STATE	N.C.	FEDERAL PROJECT DOCUMENT NO.	U-3609B
DATE	39026.1.2	PROJECT NUMBER	39026.2.2
DESIGNER	PE	CONTRACT NO.	
CONTRACTOR	UTIL. B.W.	PROJECT TITLE	
PROJECT		PROJECT SHEET	1
REVISIONS			

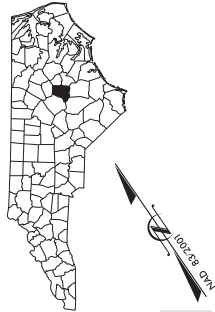

WETLAND AND SURFACE WATER IMPACTS PERMIT

END TIP PROJECT U-3609B
-L- POT STA 125+00.00

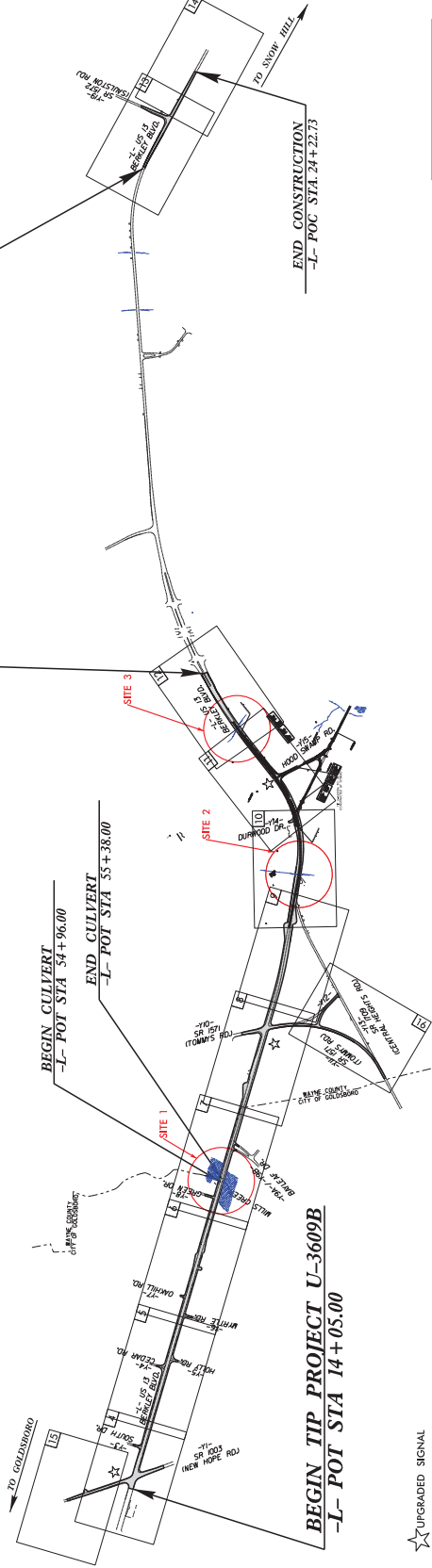

★ UPGRADED SIGNAL
CLEARING ON THIS PROJECT SHALL BE PERFORMED TO THE LIMITS ESTABLISHED BY METHOD III.
A PORTION OF THIS PROJECT IS WITHIN THE MUNICIPAL BOUNDARIES OF THE CITY OF GOLDSBORO.

GRAPHIC SCALES

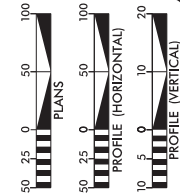

DESIGN DATA

ADT 2019 = 16,000
ADT 2040 = 18,600
K = 9 %
D = 55 %
T = 3 % *
V = 50/60 MPH
FUNC CLASS = DUAL = 2%
AND MINOR ARTERIAL
STATEWIDE TIER

PROJECT LENGTH

LENGTH ROADWAY TIP PROJECT U-3609B = 3.378 miles
LENGTH STRUCTURES TIP PROJECT U-3609B = 0.008 miles
TOTAL LENGTH TIP PROJECT U-3609B = 3.386 miles

Prepared in the Office of
Stantec



1000 Peachtree Street, N.E.
Atlanta, Georgia 30309
Tel: 404.521.8600
Fax: 404.521.8601
www.stantec.com

2018 STANDARD SPECIFICATIONS

RIGHT OF WAY DATE: 2/21/2020

LETTING DATE: 7/16/2024
(PROJ. START DATE)

PROJECT ENGINEER: STEVE SMALLWOOD, P.E.

PROJECT ENGINEER: ADDISON GAINNEY, P.E.

PROJECT ENGINEER: ADDISON GAINNEY, P.E.

HYDRAULICS ENGINEER

PROJECT ENGINEER: STEVE SMALLWOOD, P.E.

PROJECT ENGINEER: ADDISON GAINNEY, P.E.

PROJECT ENGINEER: ADDISON GAINNEY, P.E.

PROJECT ENGINEER: ADDISON GAINNEY, P.E.

PROJECT ENGINEER: ADDISON GAINNEY, P.E.



DOCUMENT NOT CONSIDERED FINAL
UNLESS ALL SIGNATURES COMPLETED

TIP PROJECT: U-3609B

CONTRACT:

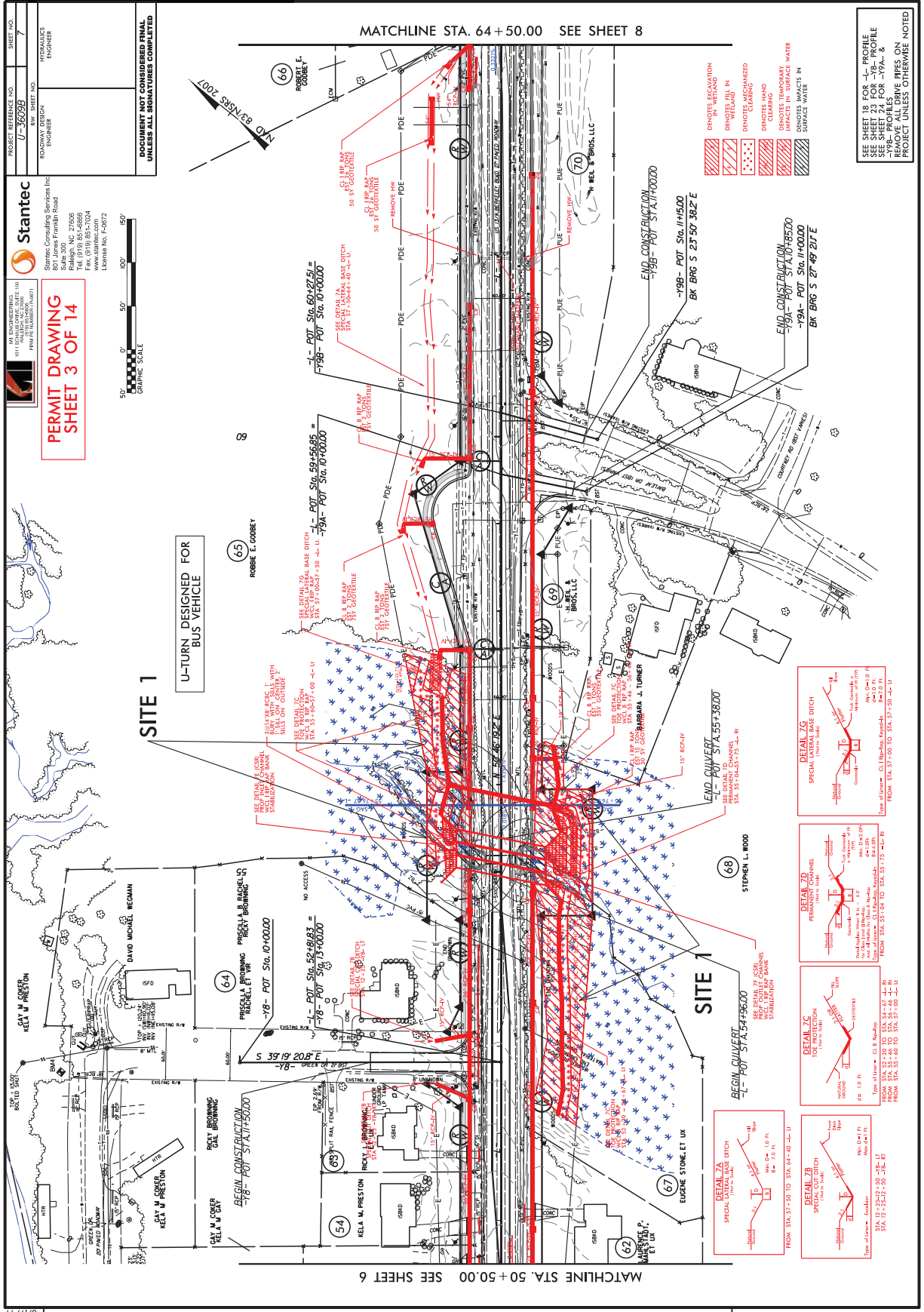

PROJECT REFERENCE NO.	U-36099
ROW SHEET NO.	7
ROW DESIGN ENGINEER	ROBERT E. COBBET
ROW DESIGNER	ROBERT E. COBBET

Stantec
 Stantec Consulting Services Inc.
 801 Jones Franklin Road
 Raleigh, NC 27605
 TEL: (919) 851-4888
 FAX: (919) 851-4889
 www.stantec.com
 License No. E-0572

PERMIT DRAWING SHEET 3 OF 14

50' 0" 50' 0" 100' 0" 150' 0" 200' 0" 250' 0" 300' 0" 350' 0" 400' 0" 450' 0" 500' 0" 550' 0" 600' 0" 650' 0" 700' 0" 750' 0" 800' 0" 850' 0" 900' 0" 950' 0" 1000' 0"

GRAPHIC SCALE

DOCUMENT NOT CONSIDERED FINAL UNLESS ALL SIGNATURES COMPLETED

SEE SHEET 18 FOR -L- PROFILE
 SEE SHEET 24 FOR -VA- PROFILE
 -YB- PROFILES ARE BASED ON PROJECT UNLESS OTHERWISE NOTED

END CONSTRUCTION -198- POT STA. 1145.00 BK BRG S 23' 50' 38.2' E

END CONSTRUCTION -199- POT STA. 1140.00 BK BRG S 27' 49' 20.7' E

END CONSTRUCTION -198- POT STA. 1145.00 BK BRG S 23' 50' 38.2' E

END CONSTRUCTION -199- POT STA. 1140.00 BK BRG S 27' 49' 20.7' E

END CONSTRUCTION -198- POT STA. 1145.00 BK BRG S 23' 50' 38.2' E

END CONSTRUCTION -199- POT STA. 1140.00 BK BRG S 27' 49' 20.7' E

END CONSTRUCTION -198- POT STA. 1145.00 BK BRG S 23' 50' 38.2' E

END CONSTRUCTION -199- POT STA. 1140.00 BK BRG S 27' 49' 20.7' E

END CONSTRUCTION -198- POT STA. 1145.00 BK BRG S 23' 50' 38.2' E

END CONSTRUCTION -199- POT STA. 1140.00 BK BRG S 27' 49' 20.7' E

ROW REV #3: ADDED CURB CUT ON PARCEL 65-07552022 SS

ROW REV #3: ADDED CURB CUT ON PARCEL 65-07552022 SS

ROW REV #3: ADDED CURB CUT ON PARCEL 65-07552022 SS

PROJECT REFERENCE NO.	U-3609B	SHEET NO.	12
ROW DESIGN ENGINEER	STANTEC	ROW SHEET NO.	12
ROW DESIGNER	STANTEC	ROW SHEET NO.	12
ROW CHECKER	STANTEC	ROW SHEET NO.	12

Stantec
 Stantec Consulting Services Inc.
 801 Jones Franklin Road
 Raleigh, NC 27605
 Tel: 919.851-6888
 Fax: 919.851-6889
 www.stantec.com
 License No. E-0972

PERMIT DRAWING SHEET 7 OF 14

ME ENGINEERING
 1001 S. WILSON ST. SUITE 200
 RAYLEIGH, NC 27605
 (919) 851-6888
 www.stantec.com

GRAPHIC SCALE
 0' 50' 100' 150'

NAD 83/NSRS 2007

DOCUMENT NOT CONSIDERED FINAL
 UNLESS ALL SIGNATURES COMPLETED

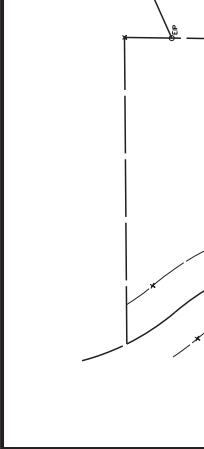

MATCHLINE STA. 115+00.00 SEE SHEET 11

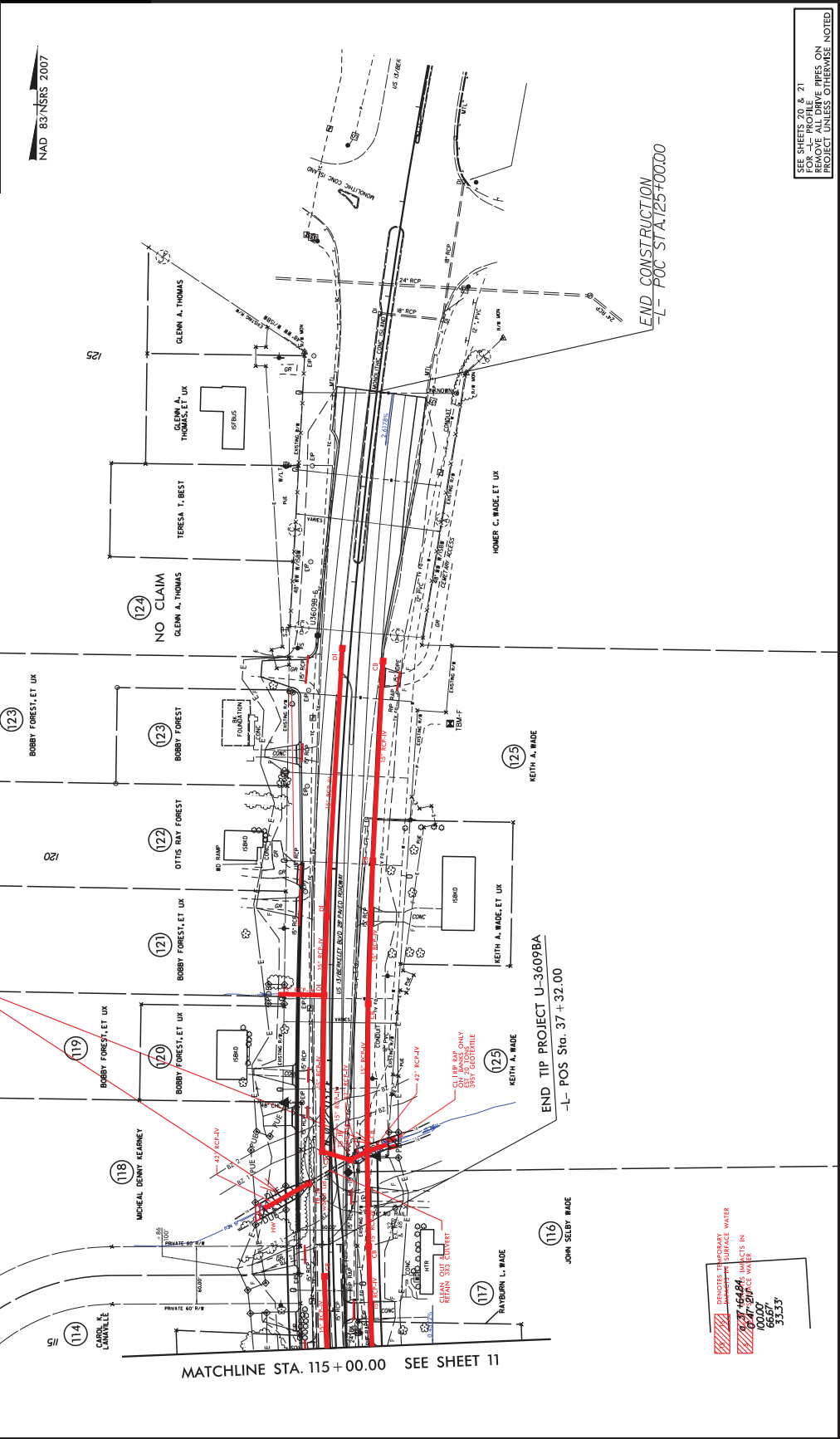

END TIP PROJECT U-3609BA
 -L- POS Sta. 37+32.00

END CONSTRUCTION
 -L- POC STA. 125+00.00

SEE SHEETS 20 & 21 FOR --L- PROFILE REMOVE ALL DRIVE PIPES ON PROJECT UNLESS OTHERWISE NOTED

LEGEND:
 Hatched area: INDICATES TEMPORARY SURFACE WATER
 6.27' 4.6484' IMPACTS IN 100' SURFACE WATER
 66.65' 33.33'

REV. 1: REVISIONS
 ROW REV. 4: ELIMINATE IMPACT ON PARCEL 124 ADDED NO CLAIM 118 AND 120.03/23/2020 SS.
 ROW REV. 3: REVISED PUE. ASSESSMENT AND ADDED DRIVE ON PARCEL 118 AND 120.03/23/2020 SS.
 B/17/19

PROJECT REFERENCE NO.	U-3609B	SHEET NO.	12
ROW DESIGN ENGINEER	STANTEC CONSULTING SERVICES INC.	ROW SHEET NO.	12
ROW DESIGNER	801 Jones Franklin Road Raleigh, NC 27606 Tel: 919.851-6888 www.stantec.com	DATE	12/11/2020
ROW ENGINEER	801 Jones Franklin Road Raleigh, NC 27606 Tel: 919.851-6888 www.stantec.com	DATE	12/11/2020

Stantec
Stantec Consulting Services Inc.
801 Jones Franklin Road
Raleigh, NC 27606
Tel: 919.851-6888
www.stantec.com

PERMIT DRAWING SHEET 8 OF 14

ME ENGINEERING
1011 S. WILSON ST. SUITE 200
RALEIGH, NC 27605
PHONE: 919.851.6888
FAX: 919.851.6889
WWW.STANTEC.COM

PROJECT REFERENCE NO. U-3609B
ROW SHEET NO. 12
DATE 12/11/2020

DOCUMENT NOT CONSIDERED FINAL
UNLESS ALL SIGNATURES COMPLETED

NAD 83/NSRS 2007

GRAPHIC SCALE
0' 50' 100' 150'

END TIP PROJECT U-3609BA
-L- POS Sta. 37+32.00

END CONSTRUCTION
-L- POC STA. 125+00.00

SEE SHEETS 20 & 21
FOR --L- PROFILE
REMOVE ALL DRIVE PIPES ON
PROJECT UNLESS OTHERWISE NOTED

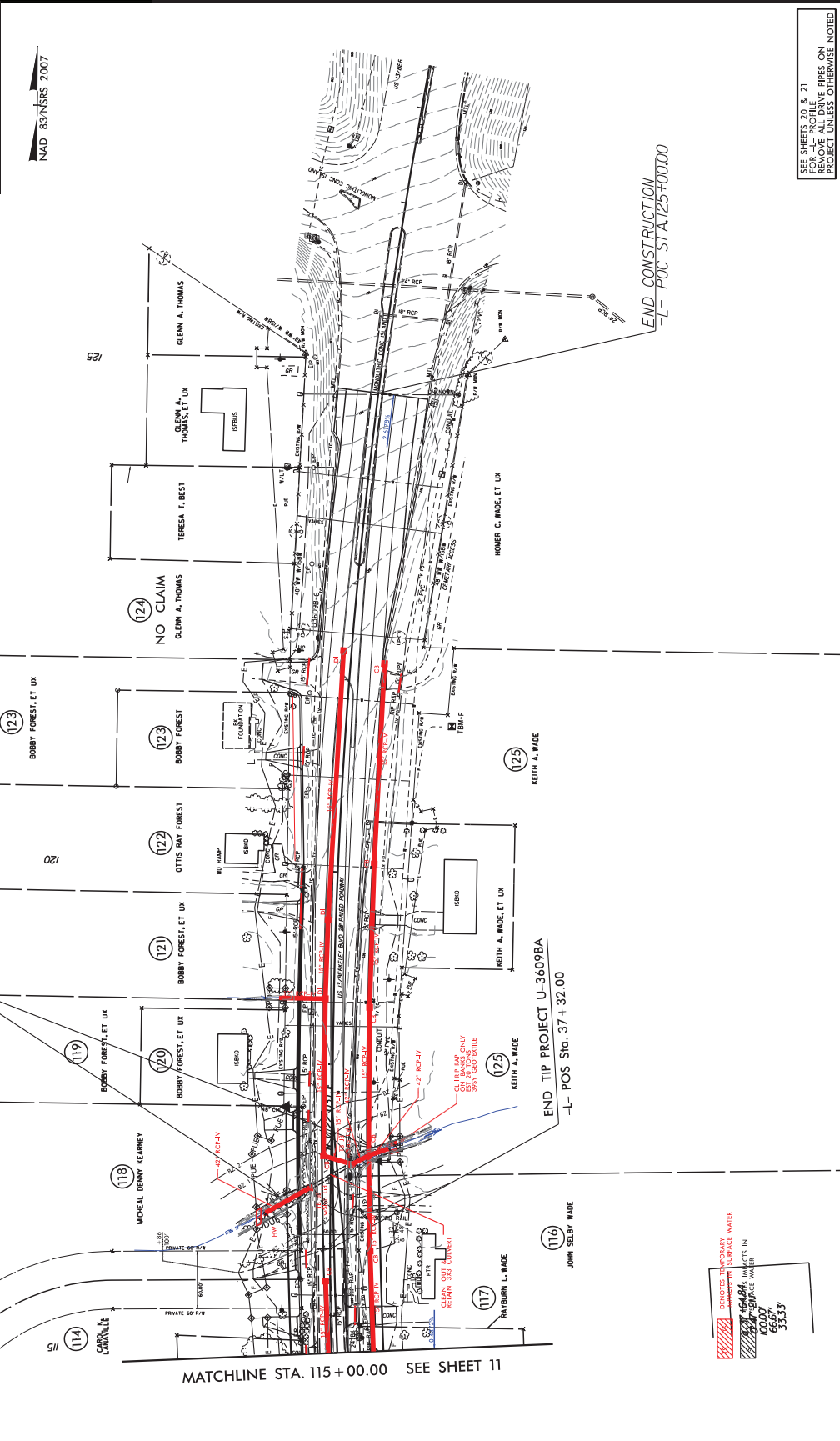

MATCHLINE STA. 115+00.00 SEE SHEET 11

REVISIONS
ROW REV. *4* ELIMINATE IMPACT ON PARCEL 124 ADDED NO CLAIM 118 AND 120.03/23/2020 SS.
ROW REV. *3* REVISED PUE. ASSESSMENT AND ADDED DRIVE ON PARCEL 118 AND 120.03/23/2020 SS.

B/17/99

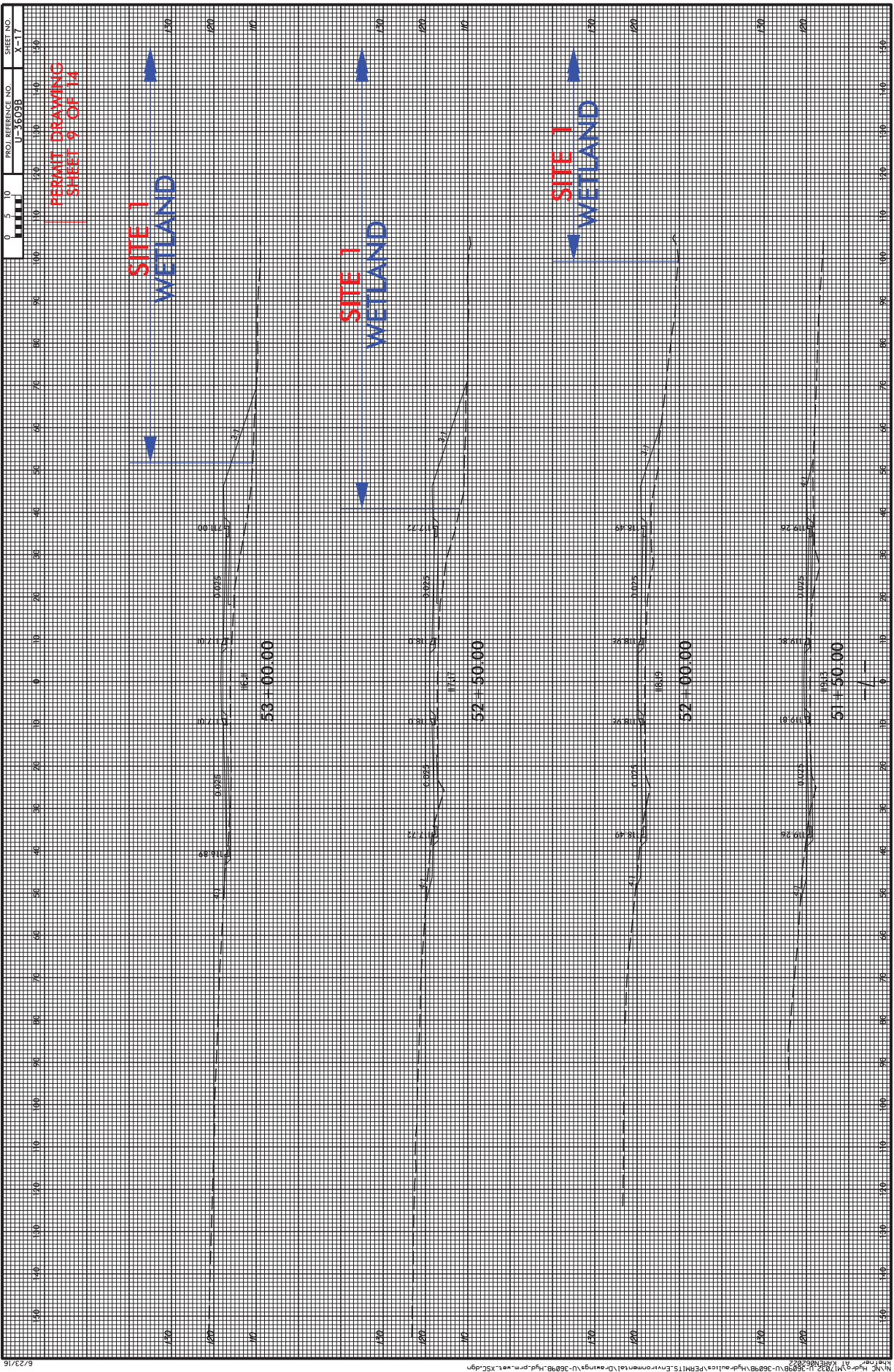

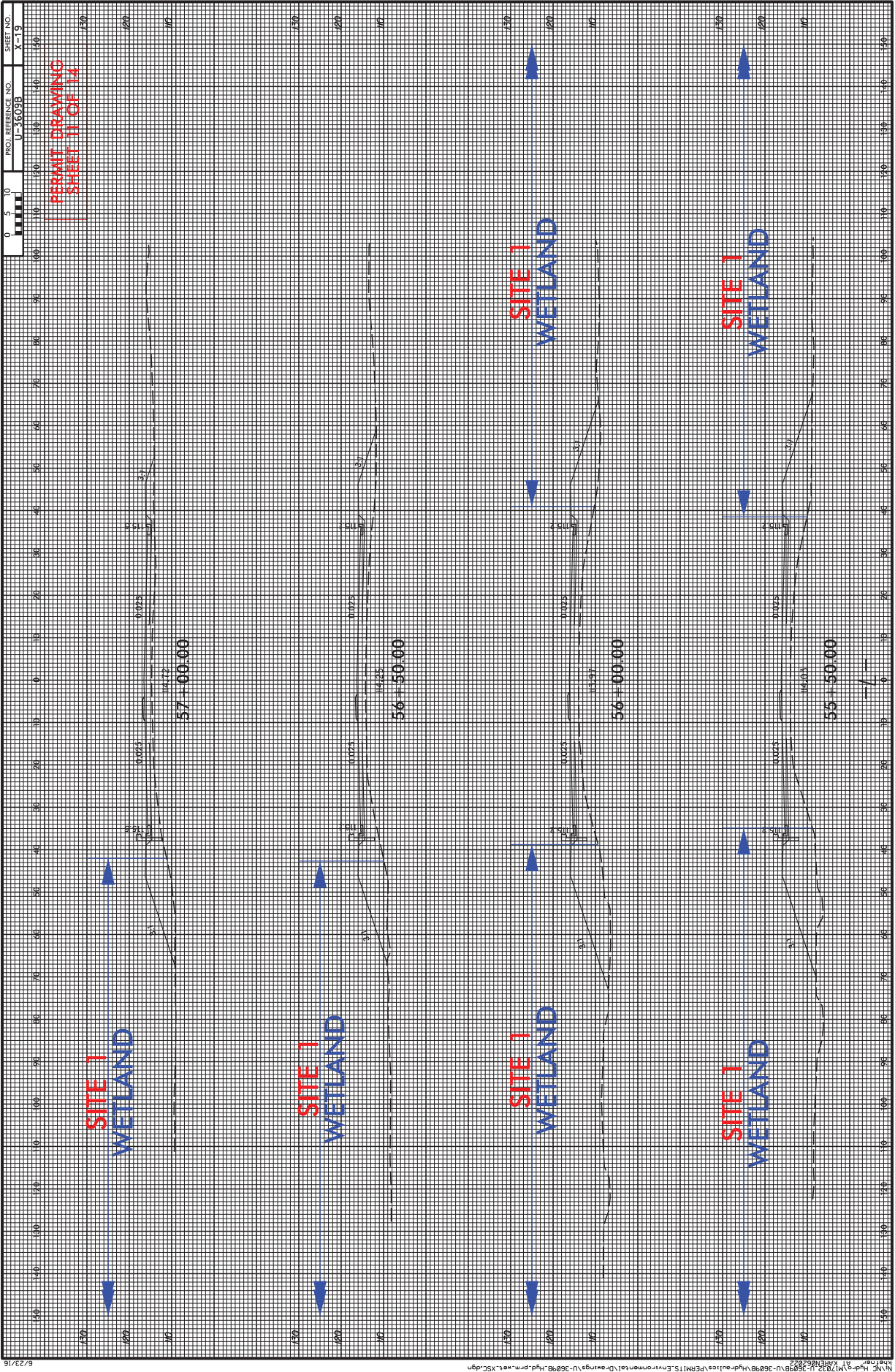

PROJ. REFERENCE NO. U-3609B
SHEET NO. X-19

PERMIT DRAWING
SHEET 11 OF 14

6/23/16

20 JUN 2016 10:23 AM
C:\Users\kare\Documents\Projects\3609B\Hydro\3609B-Hydro\3609B-Hydro\3609B-Hydro.dwg
kare

PROJECT REFERENCE NO. U-3609B	SHEET NO.
ROW SHEET NO.	
ROADWAY DESIGN ENGINEER	REGISTERED PROFESSIONAL ENGINEER
INCOMPLETE PLANS DO NOT USE FOR ADMINISTRATION	
DOCUMENT NOT CONSIDERED FINAL UNLESS ALL SIGNATURES COMPLETED	

PERMIT DRAWING
SHEET 13 OF 14

SITE 1

**CONVERT HYDRAULIC DATA
(INCLUDES 36" RCP OVERTOPPING)**

DESIGN AREA = 60 AC
 DESIGN FREQUENCY = 50 YRS
 DESIGN HW ELEVATION = 113.8 FT
 BASE DISCHARGE = 1430 CFS
 BASE FREQUENCY = 100 YRS
 BASE HW ELEVATION = 115.1 FT
 OVERTOPPING DISCHARGE = 2320 CFS
 OVERTOPPING FREQUENCY = 500 YRS
 OVERTOPPING ELEVATION = 116.5 FT

SITE 2

PIPE HYDRAULIC DATA

205" RCP -L- Sta. 16+95+62.5

DRAINAGE AREA = 166 AC
 DESIGN FREQUENCY = 50 YRS
 DESIGN DISCHARGE = 170 CFS
 DESIGN HW ELEVATION = 120.4 FT
 100 YEAR HW ELEVATION = 123.36 FT
 100 YEAR DISCHARGE = 100 YRS
 OVERTOPPING DISCHARGE = 197 CFS
 OVERTOPPING ELEVATION = 119.36 FT

SITE 3

PIPE HYDRAULIC DATA

42" RCP -L- Sta. 16+65

DRAINAGE AREA = 60.4 AC
 DESIGN FREQUENCY = 50 YRS
 DESIGN DISCHARGE = 150 CFS
 DESIGN HW ELEVATION = 119.7 FT
 100 YEAR DISCHARGE = 55 CFS
 100 YEAR HW ELEVATION = 119.37 FT
 OVERTOPPING DISCHARGE = 1500 CFS
 OVERTOPPING FREQUENCY = 100 YRS
 OVERTOPPING ELEVATION = 122.51 FT

See Sheet 1A For Inter of Sheets

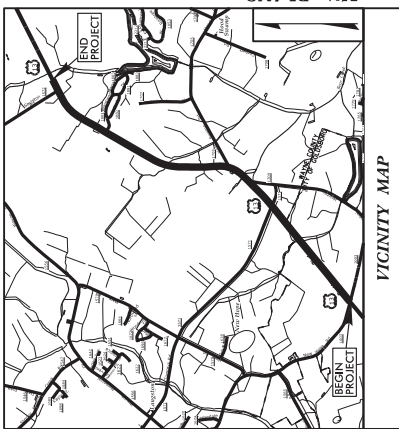

STATE OF NORTH CAROLINA
DIVISION OF HIGHWAYS

WAYNE COUNTY

LOCATION: U.S. 13 (BERKELEY BOULEVARD) FROM
SR 1003 (NEW HOPE ROAD) TO
SR 1572 (SAULSTON ROAD)

TYPE OF WORK: GRADING, PAVING, DRAINAGE
CULVERT & SIGNALS

BUFFER IMPACTS PERMIT

END TIP PROJECT U-3609B
-L- POT STA 125+00.00

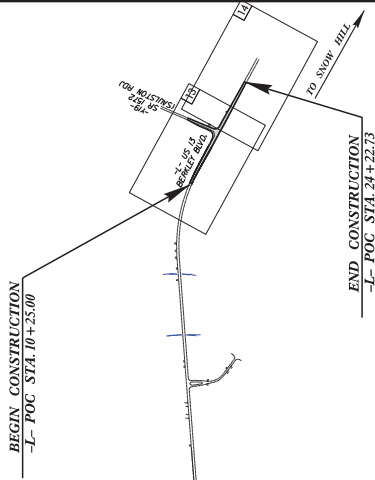
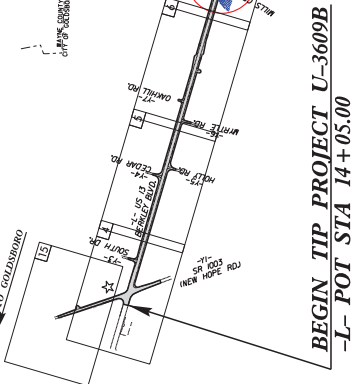

STATE	N.C.	PROJECT NUMBER	U-3609B
DATE	3/9/2020	PROJECT NAME	U.S. 13
DESIGNER	PE	PROJECT TYPE	UTIL. R/W
CHECKER	PE	PROJECT STATUS	
DATE		PROJECT COST	
SCALE		PROJECT LENGTH	
SHEET NO.	1	TOTAL SHEETS	

BUFFER DRAWING
SHEET 1 OF 9

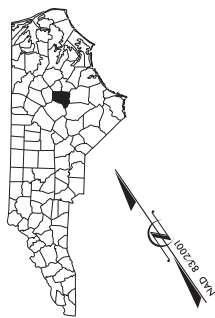

CLEARING ON THIS PROJECT SHALL BE PERFORMED TO THE LIMITS ESTABLISHED BY METHOD III.
A PORTION OF THIS PROJECT IS WITHIN THE MUNICIPAL BOUNDARIES OF THE CITY OF GOLDSBORO.

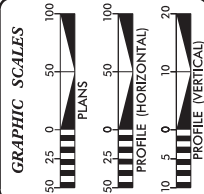

DESIGN DATA

ADT 2019	= 16,000
ADT 2040	= 18,600
K	= 9%
D	= 55%
T	= 3%
V	= 50/60 MPH
FUNC CLASS	= PRINCIPAL AND MINOR ARTERIAL
STATEWIDE TIER	

* TTST = 1% DUAL = 2%

PROJECT LENGTH

LENGTH ROADWAY TIP PROJECT U-3609B = 3.378 miles
LENGTH STRUCTURES TIP PROJECT U-3609B = 0.008 miles
TOTAL LENGTH TIP PROJECT U-3609B = 3.386 miles

Prepared in the Office of
Stantec
10000 University Blvd., Suite 100
Charlotte, NC 28226
TEL: 704.366.1000 FAX: 704.366.1001
WWW.STANTEC.COM

RIGHT OF WAY DATE: 2/21/2020
LETTING DATE: 7/16/2024
(PROJ. START DATE)

PROJECT ENGINEER: STEVE SMALLWOOD, P.E.
PROJECT ENGINEER: ADDISON GAINNEY, P.E.
PROJECT ENGINEER: ADDISON GAINNEY, P.E.

HYDRAULICS ENGINEER: _____ P.E.
ROADWAY DESIGN ENGINEER: _____ P.E.



DOCUMENT NOT CONSIDERED FINAL
UNLESS ALL SIGNATURES COMPLETED

TIP PROJECT: U-3609B

CONTRACT:

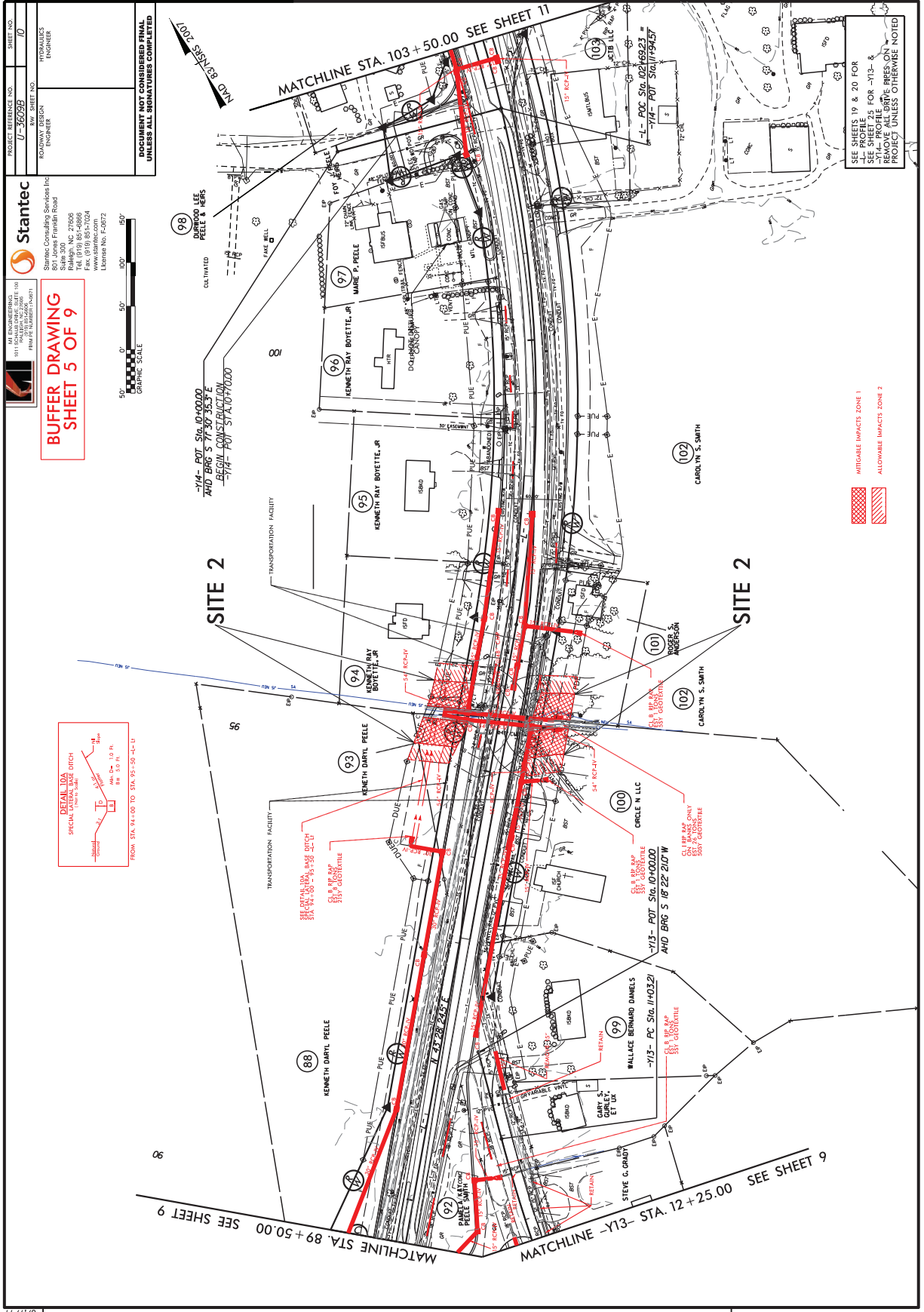

PROJECT REFERENCE NO.	U-36099	SHEET NO.	10
ROW SHEET NO.		ROW SHEET NO.	
DESIGNER	Stantec	ENGINEER	
OWNER	Stantec Consulting Services Inc	OWNER'S ENGINEER	
801 Jones Franklin Road Raleigh, NC 27606 P.O. Box 10000 Raleigh, NC 27602 License No. E-0072			

Stantec
 Stantec Consulting Services Inc
 801 Jones Franklin Road
 Raleigh, NC 27606
 P.O. Box 10000
 Raleigh, NC 27602
 License No. E-0072

ME ENGINEERING
 1001 S. Salisbury Street
 Raleigh, NC 27605
 License No. E-0072

ME ENGINEERING
 1001 S. Salisbury Street
 Raleigh, NC 27605
 License No. E-0072

ME ENGINEERING
 1001 S. Salisbury Street
 Raleigh, NC 27605
 License No. E-0072

ME ENGINEERING
 1001 S. Salisbury Street
 Raleigh, NC 27605
 License No. E-0072

SEE SHEETS 19 & 20 FOR
 SEE SHEETS 19 & 20 FOR
 SEE SHEETS 19 & 20 FOR
 SEE SHEETS 19 & 20 FOR

SEE SHEETS 19 & 20 FOR
 SEE SHEETS 19 & 20 FOR
 SEE SHEETS 19 & 20 FOR
 SEE SHEETS 19 & 20 FOR

SEE SHEETS 19 & 20 FOR
 SEE SHEETS 19 & 20 FOR
 SEE SHEETS 19 & 20 FOR
 SEE SHEETS 19 & 20 FOR

SEE SHEETS 19 & 20 FOR
 SEE SHEETS 19 & 20 FOR
 SEE SHEETS 19 & 20 FOR
 SEE SHEETS 19 & 20 FOR

SEE SHEETS 19 & 20 FOR
 SEE SHEETS 19 & 20 FOR
 SEE SHEETS 19 & 20 FOR
 SEE SHEETS 19 & 20 FOR

SEE SHEETS 19 & 20 FOR
 SEE SHEETS 19 & 20 FOR
 SEE SHEETS 19 & 20 FOR
 SEE SHEETS 19 & 20 FOR

SEE SHEETS 19 & 20 FOR
 SEE SHEETS 19 & 20 FOR
 SEE SHEETS 19 & 20 FOR
 SEE SHEETS 19 & 20 FOR

SEE SHEETS 19 & 20 FOR
 SEE SHEETS 19 & 20 FOR
 SEE SHEETS 19 & 20 FOR
 SEE SHEETS 19 & 20 FOR

SEE SHEETS 19 & 20 FOR
 SEE SHEETS 19 & 20 FOR
 SEE SHEETS 19 & 20 FOR
 SEE SHEETS 19 & 20 FOR

ROW REVISION #2: REVISED PDE & TCE STATION FLAG ON PARCEL 100, 101, & 102 -L- SS 2/16/2021

REVISIONS

REVISIONS

REVISIONS

REVISIONS

PROJECT REFERENCE NO. U-36099
 SHEET NO. 12

STANTEC CONSULTING SERVICES INC.
 801 Jones Franklin Road
 Raleigh, NC 27605
 TEL: 919.851-6888
 WWW.STANTEC.COM
 LICENSE NO. E-0972

REGISTERED PROFESSIONAL ENGINEER

DOCUMENT NOT CONSIDERED FINAL
 UNLESS ALL SIGNATURES COMPLETED

Stantec

ME ENGINEERING
 1001 S. HARRIS ST. SUITE 200
 RALEIGH, NC 27601
 PHONE: 919.851.6888

**BUFFER DRAWING
 SHEET 7 OF 9**

GRAPHIC SCALE
 0' 50' 100'

NAD 83 NSRS 2007



REVISIONS

ROW REV. REVISED PUE. ASSESSMENT AND ADDED DRIVE ON PARCEL 118 AND 120.03/23/2020 SS.

ROW REV. ELIMINATE IMPACT ON PARCEL 124. ADDED NO CLAIM. 04/22/2022 SS.

B/17/19

SEE SHEETS 20 & 21
 FOR --L- PROFILE
 REMOVE ALL DRIVE PIPES ON
 PROJECT UNLESS OTHERWISE NOTED

County: WAYNE

Line #	Item Number	Sec #	Description	Quantity	Unit Cost	Amount
ROADWAY ITEMS						
0001	0000100000-N	800	MOBILIZATION	Lump Sum	L.S.	
0002	0000400000-N	801	CONSTRUCTION SURVEYING	Lump Sum	L.S.	
0003	0050000000-E	226	SUPPLEMENTARY CLEARING & GRUBBING	1 ACR		
0004	0057000000-E	226	UNDERCUT EXCAVATION	2,350 CY		
0005	0063000000-N	SP	GRADING	Lump Sum	L.S.	
0006	0106000000-E	230	BORROW EXCAVATION	61,400 CY		
0007	0134000000-E	240	DRAINAGE DITCH EXCAVATION	200 CY		
0008	0195000000-E	265	SELECT GRANULAR MATERIAL	2,350 CY		
0009	0196000000-E	270	GEOTEXTILE FOR SOIL STABILIZATION	3,750 SY		
0010	0199000000-E	SP	TEMPORARY SHORING	450 SF		
0011	0255000000-E	SP	GENERIC GRADING ITEM HAULING AND DISPOSAL OF PETROLEUM CONTAMINATED SOIL	60 TON		
0012	0318000000-E	300	FOUNDATION CONDITIONING MATERIAL, MINOR STRUCTURES	2,360 TON		
0013	0321000000-E	300	FOUNDATION CONDITIONING GEOTEXTILE	7,400 SY		
0014	0342000000-E	310	*** SIDE DRAIN PIPE (54")	44 LF		
0015	0343000000-E	310	15" SIDE DRAIN PIPE	838 LF		
0016	0372000000-E	310	18" RC PIPE CULVERTS, CLASS III	18 LF		
0017	0378000000-E	310	24" RC PIPE CULVERTS, CLASS III	96 LF		

County: WAYNE

Line #	Item Number	Sec #	Description	Quantity	Unit Cost	Amount
0018	0390000000-E	310	36" RC PIPE CULVERTS, CLASS III	48 LF		
0019	0396000000-E	310	42" RC PIPE CULVERTS, CLASS III	16 LF		
0020	0448000000-E	310	***** RC PIPE CULVERTS, CLASS IV (54")	228 LF		
0021	0448200000-E	310	15" RC PIPE CULVERTS, CLASS IV	10,726 LF		
0022	0448300000-E	310	18" RC PIPE CULVERTS, CLASS IV	1,452 LF		
0023	0448400000-E	310	24" RC PIPE CULVERTS, CLASS IV	3,744 LF		
0024	0448500000-E	310	30" RC PIPE CULVERTS, CLASS IV	1,816 LF		
0025	0448600000-E	310	36" RC PIPE CULVERTS, CLASS IV	2,796 LF		
0026	0448700000-E	310	42" RC PIPE CULVERTS, CLASS IV	112 LF		
0027	0449000000-E	310	*** RC PIPE CULVERTS, CLASS V (15")	64 LF		
0028	0449000000-E	310	*** RC PIPE CULVERTS, CLASS V (54")	176 LF		
0029	0995000000-E	340	PIPE REMOVAL	5,507 LF		
0030	0996000000-N	350	PIPE CLEAN OUT	2 EA		
0031	1099500000-E	505	SHALLOW UNDERCUT	3,750 CY		
0032	1099700000-E	505	CLASS IV SUBGRADE STABILIZATION	9,075 TON		
0033	1111000000-E	SP	CLASS IV AGGREGATE STABILIZATION	300 TON		
0034	1112000000-E	505	GEOTEXTILE FOR SUBGRADE STABILIZATION	13,575 SY		

County: WAYNE

Line #	Item Number	Sec #	Description	Quantity	Unit Cost	Amount
0035	1220000000-E	545	INCIDENTAL STONE BASE	1,000 TON		
0036	1297000000-E	607	MILLING ASPHALT PAVEMENT, **** DEPTH (2-1/2")	46,075 SY		
0037	1330000000-E	607	INCIDENTAL MILLING	4,400 SY		
0038	1491000000-E	610	ASPHALT CONC BASE COURSE, TYPE B25.0C	21,100 TON		
0039	1503000000-E	610	ASPHALT CONC INTERMEDIATE COURSE, TYPE I19.0C	26,500 TON		
0040	1519000000-E	610	ASPHALT CONC SURFACE COURSE, TYPE S9.5B	1,800 TON		
0041	1523000000-E	610	ASPHALT CONC SURFACE COURSE, TYPE S9.5C	19,000 TON		
0042	1575000000-E	620	ASPHALT BINDER FOR PLANT MIX	3,460 TON		
0043	1693000000-E	654	ASPHALT PLANT MIX, PAVEMENT REPAIR	500 TON		
0044	1880000000-E	SP	GENERIC PAVING ITEM JOINT REPAIR	200 TON		
0045	2022000000-E	815	SUBDRAIN EXCAVATION	807 CY		
0046	2026000000-E	815	GEOTEXTILE FOR SUBSURFACE DRAINS	3,600 SY		
0047	2036000000-E	815	SUBDRAIN COARSE AGGREGATE	605 CY		
0048	2044000000-E	815	6" PERFORATED SUBDRAIN PIPE	3,600 LF		
0049	2070000000-N	815	SUBDRAIN PIPE OUTLET	8 EA		
0050	2077000000-E	815	6" OUTLET PIPE	48 LF		
0051	2209000000-E	838	ENDWALLS	29.3 CY		

County: WAYNE

Line #	Item Number	Sec #	Description	Quantity	Unit Cost	Amount
0052	2220000000-E	838	REINFORCED ENDWALLS	17.1 CY		
0053	2253000000-E	840	PIPE COLLARS	0.893 CY		
0054	2275000000-E	SP	FLOWABLE FILL	13 CY		
0055	2286000000-N	840	MASONRY DRAINAGE STRUCTURES	196 EA		
0056	2297000000-E	840	MASONRY DRAINAGE STRUCTURES	6.717 CY		
0057	2308000000-E	840	MASONRY DRAINAGE STRUCTURES	22.6 LF		
0058	2364000000-N	840	FRAME WITH TWO GRATES, STD 840.16	36 EA		
0059	2366000000-N	840	FRAME WITH TWO GRATES, STD 840.24	1 EA		
0060	2367000000-N	840	FRAME WITH TWO GRATES, STD 840.29	2 EA		
0061	2374000000-N	840	FRAME WITH GRATE & HOOD, STD 840.03, TYPE ** (E)	27 EA		
0062	2374000000-N	840	FRAME WITH GRATE & HOOD, STD 840.03, TYPE ** (F)	73 EA		
0063	2374000000-N	840	FRAME WITH GRATE & HOOD, STD 840.03, TYPE ** (G)	61 EA		
0064	2396000000-N	840	FRAME WITH COVER, STD 840.54	5 EA		
0065	2440000000-N	852	CONCRETE TRANSITIONAL SECTION FOR CATCH BASIN	15 EA		
0066	2451000000-N	852	CONCRETE TRANSITIONAL SECTION FOR DROP INLET	9 EA		
0067	2535000000-E	846	*** X *** CONCRETE CURB (8" X 12")	770 LF		
0068	2542000000-E	846	1'-6" CONCRETE CURB & GUTTER	6,700 LF		

County: WAYNE

Line #	Item Number	Sec #	Description	Quantity	Unit Cost	Amount
0069	2549000000-E	846	2'-6" CONCRETE CURB & GUTTER	23,550 LF		
0070	2591000000-E	848	4" CONCRETE SIDEWALK	2,900 SY		
0071	2605000000-N	848	CONCRETE CURB RAMPS	17 EA		
0072	2612000000-E	848	6" CONCRETE DRIVEWAY	3,120 SY		
0073	2655000000-E	852	5" MONOLITHIC CONCRETE ISLANDS (KEYED IN)	5,925 SY		
0074	2830000000-N	858	ADJUSTMENT OF MANHOLES	1 EA		
0075	3030000000-E	862	STEEL BEAM GUARDRAIL	412.5 LF		
0076	3105000000-N	862	STEEL BEAM GUARDRAIL TERMINAL SECTIONS	2 EA		
0077	3150000000-N	862	ADDITIONAL GUARDRAIL POSTS	5 EA		
0078	3210000000-N	862	GUARDRAIL END UNITS, TYPE CAT-1	2 EA		
0079	3287000000-N	862	GUARDRAIL END UNITS, TYPE TL-3	2 EA		
0080	3360000000-E	863	REMOVE EXISTING GUARDRAIL	400 LF		
0081	3628000000-E	876	RIP RAP, CLASS I	410 TON		
0082	3649000000-E	876	RIP RAP, CLASS B	150 TON		
0083	3656000000-E	876	GEOTEXTILE FOR DRAINAGE	2,900 SY		
0084	4072000000-E	903	SUPPORTS, 3-LB STEEL U-CHANNEL	3,185 LF		
0085	4096000000-N	904	SIGN ERECTION, TYPE D	1 EA		

County: WAYNE

Line #	Item Number	Sec #	Description	Quantity	Unit Cost	Amount
0086	4102000000-N	904	SIGN ERECTION, TYPE E	119 EA		
0087	4108000000-N	904	SIGN ERECTION, TYPE F	22 EA		
0088	4116100000-N	904	SIGN ERECTION, RELOCATE TYPE **** (GROUND MOUNTED) (D)	5 EA		
0089	4116100000-N	904	SIGN ERECTION, RELOCATE TYPE **** (GROUND MOUNTED) (E)	8 EA		
0090	4116100000-N	904	SIGN ERECTION, RELOCATE TYPE **** (GROUND MOUNTED) (F)	1 EA		
0091	4141000000-N	907	DISPOSAL OF SUPPORT, WOOD	1 EA		
0092	4155000000-N	907	DISPOSAL OF SIGN SYSTEM, U- CHANNEL	53 EA		
0093	4158000000-N	907	DISPOSAL OF SIGN SYSTEM, WOOD	1 EA		
0094	4192000000-N	907	DISPOSAL OF SUPPORT, U-CHANNEL	14 EA		
0095	4400000000-E	1110	WORK ZONE SIGNS (STATIONARY)	1,716 SF		
0096	4405000000-E	1110	WORK ZONE SIGNS (PORTABLE)	180 SF		
0097	4410000000-E	1110	WORK ZONE SIGNS (BARRICADE MOUNTED)	252 SF		
0098	4420000000-N	1120	PORTABLE CHANGEABLE MESSAGE SIGN	2 EA		
0099	4430000000-N	1130	DRUMS	1,500 EA		
0100	4435000000-N	1135	CONES	500 EA		
0101	4445000000-E	1145	BARRICADES (TYPE III)	488 LF		
0102	4455000000-N	1150	FLAGGER	1,080 DAY		

County: WAYNE

Line #	Item Number	Sec #	Description	Quantity	Unit Cost	Amount
0103	4465000000-N	1160	TEMPORARY CRASH CUSHIONS	2 EA		
0104	4485000000-E	1170	PORTABLE CONCRETE BARRIER	120 LF		
0105	4507000000-E	1170	WATER FILLED BARRIER	500 LF		
0106	4510000000-N	1190	LAW ENFORCEMENT	120 HR		
0107	4650000000-N	1251	TEMPORARY RAISED PAVEMENT MARKERS	630 EA		
0108	4688000000-E	1205	THERMOPLASTIC PAVEMENT MARKING LINES (6", 90 MILS)	50,234 LF		
0109	4700000000-E	1205	THERMOPLASTIC PAVEMENT MARKING LINES (12", 90 MILS)	8,118 LF		
0110	4709000000-E	1205	THERMOPLASTIC PAVEMENT MARKING LINES (24", 90 MILS)	785 LF		
0111	4725000000-E	1205	THERMOPLASTIC PAVEMENT MARKING SYMBOL (90 MILS)	115 EA		
0112	4810000000-E	1205	PAINT PAVEMENT MARKING LINES (4")	250,335 LF		
0113	4820000000-E	1205	PAINT PAVEMENT MARKING LINES (8")	12,220 LF		
0114	4835000000-E	1205	PAINT PAVEMENT MARKING LINES (24")	1,590 LF		
0115	4845000000-N	1205	PAINT PAVEMENT MARKING SYMBOL	378 EA		
0116	4850000000-E	1205	REMOVAL OF PAVEMENT MARKING LINES (4")	500 LF		
0117	4860000000-E	1205	REMOVAL OF PAVEMENT MARKING LINES (8")	249 LF		
0118	4875000000-N	1205	REMOVAL OF PAVEMENT MARKING SYMBOLS & CHARACTERS	13 EA		
0119	4890000000-E	SP	GENERIC PAVEMENT MARKING ITEM YIELD LINE PAINT PAVEMENT MARKING (24")	100 LF		

County: WAYNE

Line #	Item Number	Sec #	Description	Quantity	Unit Cost	Amount
0120	4890000000-E	SP	GENERIC PAVEMENT MARKING ITEM YIELD LINE THERMOPLASTIC PAVEMENT MARKING (24", 90MILS)	40 LF		
0121	4895000000-N	SP	GENERIC PAVEMENT MARKING ITEM POLYCARBONATE H-SHAPED MARKERS	1,775 EA		
0122	5325000000-E	1510	*** WATER LINE (18")	296 LF		
0123	5325600000-E	1510	6" WATER LINE	20 LF		
0124	5325800000-E	1510	8" WATER LINE	323 LF		
0125	5326600000-E	1510	16" WATER LINE	5,063 LF		
0126	5329000000-E	1510	DUCTILE IRON WATER PIPE FITTINGS	19,855 LB		
0127	5540000000-E	1515	6" VALVE	12 EA		
0128	5546000000-E	1515	8" VALVE	7 EA		
0129	5558600000-E	1515	16" VALVE	11 EA		
0130	5648000000-N	1515	RELOCATE WATER METER	68 EA		
0131	5649000000-N	1515	RECONNECT WATER METER	11 EA		
0132	5666000000-N	1515	FIRE HYDRANT	11 EA		
0133	5673000000-E	1515	FIRE HYDRANT LEG	76 LF		
0134	5678600000-E	1515	8" LINE STOP	4 EA		
0135	5686000000-E	1515	*** WATER SERVICE LINE (2")	197 LF		
0136	5686500000-E	1515	WATER SERVICE LINE	2,339 LF		

County: WAYNE

Line #	Item Number	Sec #	Description	Quantity	Unit Cost	Amount
0137	5768000000-N	1520	SANITARY SEWER CLEAN-OUT	17 EA		
0138	5801000000-E	1530	ABANDON 8" UTILITY PIPE	235 LF		
0139	5810000000-E	1530	ABANDON 16" UTILITY PIPE	5,323 LF		
0140	5815500000-N	1530	REMOVE FIRE HYDRANT	11 EA		
0141	5872600000-E	1550	DIRECTIONAL DRILLING OF *** (18")	211 LF		
0142	6000000000-E	1605	TEMPORARY SILT FENCE	45,690 LF		
0143	6006000000-E	1610	STONE FOR EROSION CONTROL, CLASS A	1,120 TON		
0144	6009000000-E	1610	STONE FOR EROSION CONTROL, CLASS B	4,010 TON		
0145	6012000000-E	1610	SEDIMENT CONTROL STONE	3,680 TON		
0146	6015000000-E	1615	TEMPORARY MULCHING	40.5 ACR		
0147	6018000000-E	1620	SEED FOR TEMPORARY SEEDING	2,100 LB		
0148	6021000000-E	1620	FERTILIZER FOR TEMPORARY SEEDING	11 TON		
0149	6024000000-E	1622	TEMPORARY SLOPE DRAINS	585 LF		
0150	6029000000-E	SP	SAFETY FENCE	1,120 LF		
0151	6030000000-E	1630	SILT EXCAVATION	23,370 CY		
0152	6036000000-E	1631	MATTING FOR EROSION CONTROL	20,500 SY		
0153	6037000000-E	1629	COIR FIBER MAT	920 SY		

County: WAYNE

Line #	Item Number	Sec #	Description	Quantity	Unit Cost	Amount
0154	6042000000-E	1632	1/4" HARDWARE CLOTH	10,650 LF		
0155	6070000000-N	1639	SPECIAL STILLING BASINS	4 EA		
0156	6071002000-E	1642	FLOCCULANT	5,390 LB		
0157	6071012000-E	1642	COIR FIBER WATTLE	8,360 LF		
0158	6071030000-E	1640	COIR FIBER BAFFLE	3,760 LF		
0159	6071050000-E	1644	*** SKIMMER (1-1/2")	18 EA		
0160	6071050000-E	1644	*** SKIMMER (2")	3 EA		
0161	6071050000-E	1644	*** SKIMMER (2-1/2")	4 EA		
0162	6084000000-E	1660	SEEDING & MULCHING	50 ACR		
0163	6087000000-E	1660	MOWING	27 ACR		
0164	6090000000-E	1661	SEED FOR REPAIR SEEDING	450 LB		
0165	6093000000-E	1661	FERTILIZER FOR REPAIR SEEDING	2 TON		
0166	6096000000-E	1662	SEED FOR SUPPLEMENTAL SEEDING	725 LB		
0167	6108000000-E	1665	FERTILIZER TOPDRESSING	21.5 TON		
0168	6111000000-E	SP	IMPERVIOUS DIKE	445 LF		
0169	6114500000-N	1667	SPECIALIZED HAND MOWING	10 MHR		
0170	6114800000-N	SP	MANUAL LITTER REMOVAL	15 MHR		

County: WAYNE

Line #	Item Number	Sec #	Description	Quantity	Unit Cost	Amount
0171	6114900000-E	SP	LITTER DISPOSAL	4 TON		
0172	6117000000-N	1675	RESPONSE FOR EROSION CONTROL	100 EA		
0173	6117500000-N	SP	CONCRETE WASHOUT STRUCTURE	2 EA		
0174	6120000000-E	SP	CULVERT DIVERSION CHANNEL	192 CY		
0175	6123000000-E	1670	REFORESTATION	0.1 ACR		
0176	6132000000-N	SP	GENERIC EROSION CONTROL ITEM PREFABRICATED CONCRETE WASHOUT	12 EA		
0177	7048500000-E	1705	PEDESTRIAN SIGNAL HEAD (16", 1 SECTION W/COUNTDOWN)	2 EA		
0178	7060000000-E	1705	SIGNAL CABLE	8,970 LF		
0179	7120000000-E	1705	VEHICLE SIGNAL HEAD (12", 3 SECTION)	56 EA		
0180	7132000000-E	1705	VEHICLE SIGNAL HEAD (12", 4 SECTION)	8 EA		
0181	7144000000-E	1705	VEHICLE SIGNAL HEAD (12", 5 SECTION)	1 EA		
0182	7252000000-E	1710	MESSENGER CABLE (1/4")	2,160 LF		
0183	7264000000-E	1710	MESSENGER CABLE (3/8")	3,270 LF		
0184	7279000000-E	1715	TRACER WIRE	3,770 LF		
0185	7300000000-E	1715	UNPAVED TRENCHING (***** (1, 2")	850 LF		
0186	7300000000-E	1715	UNPAVED TRENCHING (***** (2, 2")	2,720 LF		
0187	7300000000-E	1715	UNPAVED TRENCHING (***** (3, 2")	40 LF		

County: WAYNE

Line #	Item Number	Sec #	Description	Quantity	Unit Cost	Amount
0188	7301000000-E	1715	DIRECTIONAL DRILL (***** (2, 2"))	1,427 LF		
0189	7312000000-N	1716	JUNCTION BOX (***** (SPECIAL OVER-SIZED, HEAVY DUTY)	2 EA		
0190	7324000000-N	1716	JUNCTION BOX (STANDARD SIZE)	19 EA		
0191	7348000000-N	1716	JUNCTION BOX (OVER-SIZED, HEAVY DUTY)	17 EA		
0192	7360000000-N	1720	WOOD POLE	13 EA		
0193	7372000000-N	1721	GUY ASSEMBLY	34 EA		
0194	7408000000-E	1722	1" RISER WITH WEATHERHEAD	3 EA		
0195	7420000000-E	1722	2" RISER WITH WEATHERHEAD	8 EA		
0196	7432000000-E	1722	2" RISER WITH HEAT SHRINK TUBING	5 EA		
0197	7444000000-E	1725	INDUCTIVE LOOP SAWCUT	600 LF		
0198	7456100000-E	1726	LEAD-IN CABLE (14-2)	2,110 LF		
0199	7516000000-E	1730	COMMUNICATIONS CABLE (** FIBER) (24)	12,699 LF		
0200	7528000000-E	1730	DROP CABLE	305 LF		
0201	7540000000-N	1731	SPLICE ENCLOSURE	3 EA		
0202	7541000000-N	1731	MODIFY SPLICE ENCLOSURE	1 EA		
0203	7552000000-N	1731	INTERCONNECT CENTER	4 EA		
0204	7566000000-N	1733	DELINEATOR MARKER	18 EA		

County: WAYNE

Line #	Item Number	Sec #	Description	Quantity	Unit Cost	Amount
0205	7575142060-N	1737	MODIFY RADIO INSTALLATION	1 EA		
0206	7576000000-N	SP	METAL STRAIN SIGNAL POLE	9 EA		
0207	7613000000-N	SP	SOIL TEST	9 EA		
0208	7614100000-E	SP	DRILLED PIER FOUNDATION	67.5 CY		
0209	7636000000-N	1745	SIGN FOR SIGNALS	6 EA		
0210	7642200000-N	1743	TYPE II PEDESTAL WITH FOUNDATION	2 EA		
0211	7684000000-N	1750	SIGNAL CABINET FOUNDATION	3 EA		
0212	7696000000-N	1751	CONTROLLERS WITH CABINET (*****) (TYPE 2070LX, BASE MOUNTED)	5 EA		
0213	7744000000-N	1751	DETECTOR CARD (TYPE 170)	12 EA		
0214	7901000000-N	1753	CABINET BASE EXTENDER	5 EA		
0215	7960000000-N	SP	METAL POLE FOUNDATION REMOVAL	1 EA		
0216	7972000000-N	SP	METAL POLE REMOVAL	1 EA		
0217	7980000000-N	SP	GENERIC SIGNAL ITEM ETHERNET EDGE SWITCH	3 EA		
0218	7980000000-N	SP	GENERIC SIGNAL ITEM MICROWAVE VEHICLE DETECTION SYSTEM - MULTIPLE ZONES	15 EA		
CULVERT ITEMS						
0219	8056000000-N	402	REMOVAL OF EXISTING STRUCTURE AT STATION ***** (55+17.00 -L-)	Lump Sum	L.S.	
0220	8130000000-N	414	BOX CULVERT EXCAVATION, STA ***** (55+17.00 -L-)	Lump Sum	L.S.	

County: WAYNE

Line #	Item Number	Sec #	Description	Quantity	Unit Cost	Amount
0221	8133000000-E	414	FOUNDATION CONDITIONING MATERIAL, BOX CULVERT	355 TON		
0222	8196000000-E	420	CLASS A CONCRETE (CULVERT)	594.3 CY		
0223	8245000000-E	425	REINFORCING STEEL (CULVERT)	85,862 LB		

1225/Jan12/Q945692.01/D980382436060/E223

Total Amount Of Bid For Entire Project :

Vendor 1 of 8: BRANCH CIVIL INC (3697)
Call Order 003 (Proposal: C205035)

Bid Information

Proposal County: WAYNE	Bid Checksum: B126266D97
Vendor Address: P.O. Box 40004 ROANOKE , VA , 24022	Bid Total: \$30,715,185.00
Signature Check: Michael Andrew Colbert	Items Total: \$30,715,185.00
Time Bid Received: February 17, 2026 12:13 PM	Time Total: \$0.00
Amendment Count: 0	

Bidding Errors:
None.

Vendor 1 of 8: BRANCH CIVIL INC (3697)
Call Order 003 (Proposal: C205035)

Bid Bond Information

Projects:	Bond Maximum:
Counties:	State of Incorporation:
Bond ID: SNC0205392041	Agency Execution Date: 02/05/2026 01:19:24 PM
Paid by Check: No	Surety Name: Surety2000
Bond Percent: 5%	Bond Agency Name: Hartford Fire Insurance Company

BondID: SNC0205392041
Surety Registry Agency: Surety2000
Verified?: 1
Surety Agency: Hartford Fire Insurance Company
Bond Execution Date: 02/05/2026 01:19:24 PM

Line Number	Item Number	Quantity	Unit	Unit Price	Extension Price
Section 0001 ROADWAY ITEMS					
0001	0000100000-N MOBILIZATION	1.000	LS	\$1,380,830.0000	\$1,380,830.00
0002	0000400000-N CONSTRUCTION SURVEYING	1.000	LS	\$313,490.0000	\$313,490.00
0003	0050000000-E SUPPLEMENTARY CLEARING & GRUBBING	1.000	ACR	\$11,177.0000	\$11,177.00
0004	0057000000-E UNDERCUT EXCAVATION	2350.000	CY	\$22.4500	\$52,757.50
0005	0063000000-N GRADING	1.000	LS	\$1,628,381.8400	\$1,628,381.84
0006	0106000000-E BORROW EXCAVATION	61400.000	CY	\$25.5000	\$1,565,700.00
0007	0134000000-E DRAINAGE DITCH EXCAVATION	200.000	CY	\$31.0500	\$6,210.00
0008	0195000000-E SELECT GRANULAR MATERIAL	2350.000	CY	\$25.5000	\$59,925.00
0009	0196000000-E GEOTEXTILE FOR SOIL STABILIZATION	3750.000	SY	\$3.5000	\$13,125.00
0010	0199000000-E TEMPORARY SHORING	450.000	SF	\$130.0000	\$58,500.00
0011	0255000000-E GENERIC GRADING ITEM HAULING AND DISPOSAL OF PETROLEUM CONTAMINATED SOIL	60.000	TON	\$89.5000	\$5,370.00
0012	0318000000-E FOUNDATION CONDITIONING MATERIAL, MINOR STRUCTURES	2360.000	TON	\$86.5000	\$204,140.00
0013	0321000000-E FOUNDATION CONDITIONING GEOTEXTILE	7400.000	SY	\$2.6500	\$19,610.00
0014	0342000000-E *** SIDE DRAIN PIPE (54")	44.000	LF	\$242.0000	\$10,648.00
0015	0343000000-E 15" SIDE DRAIN PIPE	838.000	LF	\$65.5000	\$54,889.00
0016	0372000000-E 18" RC PIPE CULVERTS, CLASS III	18.000	LF	\$155.0000	\$2,790.00
0017	0378000000-E 24" RC PIPE CULVERTS, CLASS III	96.000	LF	\$141.0000	\$13,536.00
0018	0390000000-E 36" RC PIPE CULVERTS, CLASS III	48.000	LF	\$258.0000	\$12,384.00
0019	0396000000-E 42" RC PIPE CULVERTS, CLASS III	16.000	LF	\$511.0000	\$8,176.00
0020	0448000000-E **** RC PIPE CULVERTS, CLASS IV (54")	228.000	LF	\$725.0000	\$165,300.00
0021	0448200000-E 15" RC PIPE CULVERTS, CLASS IV	10726.000	LF	\$93.7500	\$1,005,562.50
0022	0448300000-E 18" RC PIPE CULVERTS, CLASS IV	1452.000	LF	\$110.0000	\$159,720.00
0023	0448400000-E 24" RC PIPE CULVERTS, CLASS IV	3744.000	LF	\$164.0000	\$614,016.00

0024	0448500000-E	1816.000	LF	\$230.0000	\$417,680.00
	30" RC PIPE CULVERTS, CLASS IV				
0025	0448600000-E	2796.000	LF	\$309.0000	\$863,964.00
	36" RC PIPE CULVERTS, CLASS IV				
0026	0448700000-E	112.000	LF	\$454.0000	\$50,848.00
	42" RC PIPE CULVERTS, CLASS IV				
0027	0449000000-E	64.000	LF	\$116.0000	\$7,424.00
	*** RC PIPE CULVERTS, CLASS V (15")				
0028	0449000000-E	176.000	LF	\$846.0000	\$148,896.00
	*** RC PIPE CULVERTS, CLASS V (54")				
0029	0995000000-E	5507.000	LF	\$47.0000	\$258,829.00
	PIPE REMOVAL				
0030	0996000000-N	2.000	EA	\$29,985.0000	\$59,970.00
	PIPE CLEAN OUT				
0031	1099500000-E	3750.000	CY	\$20.4000	\$76,500.00
	SHALLOW UNDERCUT				
0032	1099700000-E	9075.000	TON	\$55.0000	\$499,125.00
	CLASS IV SUBGRADE STABILIZATION				
0033	1111000000-E	300.000	TON	\$55.0000	\$16,500.00
	CLASS IV AGGREGATE STABILIZATION				
0034	1112000000-E	13575.000	SY	\$4.4500	\$60,408.75
	GEOTEXTILE FOR SUBGRADE STABILIZATION				
0035	1220000000-E	1000.000	TON	\$61.5000	\$61,500.00
	INCIDENTAL STONE BASE				
0036	1297000000-E	46075.000	SY	\$2.7000	\$124,402.50
	MILLING ASPHALT PAVEMENT, ***" DEPTH (2-1/2")				
0037	1330000000-E	4400.000	SY	\$8.4000	\$36,960.00
	INCIDENTAL MILLING				
0038	1491000000-E	21100.000	TON	\$93.0000	\$1,962,300.00
	ASPHALT CONC BASE COURSE, TYPE B25.0C				
0039	1503000000-E	26500.000	TON	\$93.0000	\$2,464,500.00
	ASPHALT CONC INTERMEDIATE COURSE, TYPE I19.0C				
0040	1519000000-E	1800.000	TON	\$146.0000	\$262,800.00
	ASPHALT CONC SURFACE COURSE, TYPE S9.5B				
0041	1523000000-E	19000.000	TON	\$106.0000	\$2,014,000.00
	ASPHALT CONC SURFACE COURSE, TYPE S9.5C				
0042	1575000000-E	3460.000	TON	\$598.0000	\$2,069,080.00
	ASPHALT BINDER FOR PLANT MIX				
0043	1693000000-E	500.000	TON	\$266.0000	\$133,000.00
	ASPHALT PLANT MIX, PAVEMENT REPAIR				
0044	1880000000-E	200.000	TON	\$447.0000	\$89,400.00
	GENERIC PAVING ITEM JOINT REPAIR				
0045	2022000000-E	807.000	CY	\$32.2000	\$25,985.40
	SUBDRAIN EXCAVATION				
0046	2026000000-E	3600.000	SY	\$5.9000	\$21,240.00
	GEOTEXTILE FOR SUBSURFACE DRAINS				
0047	2036000000-E	605.000	CY	\$137.0000	\$82,885.00
	SUBDRAIN COARSE AGGREGATE				
0048	2044000000-E	3600.000	LF	\$13.7500	\$49,500.00

6" PERFORATED SUBDRAIN PIPE

0049	2070000000-N	8.000 EA	\$1,271.0000	\$10,168.00
	SUBDRAIN PIPE OUTLET			
0050	2077000000-E	48.000 LF	\$105.0000	\$5,040.00
	6" OUTLET PIPE			
0051	2209000000-E	29.300 CY	\$1,946.0000	\$57,017.80
	ENDWALLS			
0052	2220000000-E	17.100 CY	\$3,761.0000	\$64,313.10
	REINFORCED ENDWALLS			
0053	2253000000-E	0.893 CY	\$7,743.0000	\$6,914.50
	PIPE COLLARS			
0054	2275000000-E	13.000 CY	\$1,241.0000	\$16,133.00
	FLOWABLE FILL			
0055	2286000000-N	196.000 EA	\$3,725.0000	\$730,100.00
	MASONRY DRAINAGE STRUCTURES			
0056	2297000000-E	6.717 CY	\$8,690.0000	\$58,370.73
	MASONRY DRAINAGE STRUCTURES			
0057	2308000000-E	22.600 LF	\$1,502.0000	\$33,945.20
	MASONRY DRAINAGE STRUCTURES			
0058	2364000000-N	36.000 EA	\$1,935.0000	\$69,660.00
	FRAME WITH TWO GRATES, STD 840.16			
0059	2366000000-N	1.000 EA	\$1,740.0000	\$1,740.00
	FRAME WITH TWO GRATES, STD 840.24			
0060	2367000000-N	2.000 EA	\$1,777.0000	\$3,554.00
	FRAME WITH TWO GRATES, STD 840.29			
0061	2374000000-N	27.000 EA	\$2,044.0000	\$55,188.00
	FRAME WITH GRATE & HOOD, STD 840.03, TYPE ** (E)			
0062	2374000000-N	73.000 EA	\$2,106.0000	\$153,738.00
	FRAME WITH GRATE & HOOD, STD 840.03, TYPE ** (F)			
0063	2374000000-N	61.000 EA	\$2,106.0000	\$128,466.00
	FRAME WITH GRATE & HOOD, STD 840.03, TYPE ** (G)			
0064	2396000000-N	5.000 EA	\$1,269.0000	\$6,345.00
	FRAME WITH COVER, STD 840.54			
0065	2440000000-N	15.000 EA	\$1,248.0000	\$18,720.00
	CONCRETE TRANSITIONAL SECTION FOR CATCH BASIN			
0066	2451000000-N	9.000 EA	\$1,248.0000	\$11,232.00
	CONCRETE TRANSITIONAL SECTION FOR DROP INLET			
0067	2535000000-E	770.000 LF	\$31.1000	\$23,947.00
	*** X *** CONCRETE CURB (8" X 12")			
0068	2542000000-E	6700.000 LF	\$31.1000	\$208,370.00
	1'-6" CONCRETE CURB & GUTTER			
0069	2549000000-E	23550.000 LF	\$36.7000	\$864,285.00
	2'-6" CONCRETE CURB & GUTTER			
0070	2591000000-E	2900.000 SY	\$64.0000	\$185,600.00
	4" CONCRETE SIDEWALK			
0071	2605000000-N	17.000 EA	\$2,837.0000	\$48,229.00
	CONCRETE CURB RAMPS			
0072	2612000000-E	3120.000 SY	\$87.7500	\$273,780.00
	6" CONCRETE DRIVEWAY			

0073	2655000000-E	5925.000 SY	\$87.7500	\$519,918.75
	5" MONOLITHIC CONCRETE ISLANDS (KEYED IN)			
0074	2830000000-N	1.000 EA	\$384.0000	\$384.00
	ADJUSTMENT OF MANHOLES			
0075	3030000000-E	412.500 LF	\$42.2500	\$17,428.13
	STEEL BEAM GUARDRAIL			
0076	3105000000-N	2.000 EA	\$112.0000	\$224.00
	STEEL BEAM GUARDRAIL TERMINAL SECTIONS			
0077	3150000000-N	5.000 EA	\$49.2000	\$246.00
	ADDITIONAL GUARDRAIL POSTS			
0078	3210000000-N	2.000 EA	\$1,062.0000	\$2,124.00
	GUARDRAIL END UNITS, TYPE CAT-1			
0079	3287000000-N	2.000 EA	\$3,744.0000	\$7,488.00
	GUARDRAIL END UNITS, TYPE TL-3			
0080	3360000000-E	400.000 LF	\$1.1000	\$440.00
	REMOVE EXISTING GUARDRAIL			
0081	3628000000-E	410.000 TON	\$127.0000	\$52,070.00
	RIP RAP, CLASS I			
0082	3649000000-E	150.000 TON	\$109.0000	\$16,350.00
	RIP RAP, CLASS B			
0083	3656000000-E	2900.000 SY	\$4.3500	\$12,615.00
	GEOTEXTILE FOR DRAINAGE			
0084	4072000000-E	3185.000 LF	\$10.7000	\$34,079.50
	SUPPORTS, 3-LB STEEL U-CHANNEL			
0085	4096000000-N	1.000 EA	\$178.0000	\$178.00
	SIGN ERECTION, TYPE D			
0086	4102000000-N	119.000 EA	\$88.7500	\$10,561.25
	SIGN ERECTION, TYPE E			
0087	4108000000-N	22.000 EA	\$118.0000	\$2,596.00
	SIGN ERECTION, TYPE F			
0088	4116100000-N	5.000 EA	\$178.0000	\$890.00
	SIGN ERECTION, RELOCATE TYPE **** (GROUND MOUNTED) (D)			
0089	4116100000-N	8.000 EA	\$178.0000	\$1,424.00
	SIGN ERECTION, RELOCATE TYPE **** (GROUND MOUNTED) (E)			
0090	4116100000-N	1.000 EA	\$178.0000	\$178.00
	SIGN ERECTION, RELOCATE TYPE **** (GROUND MOUNTED) (F)			
0091	4141000000-N	1.000 EA	\$59.2500	\$59.25
	DISPOSAL OF SUPPORT, WOOD			
0092	4155000000-N	53.000 EA	\$2.3500	\$124.55
	DISPOSAL OF SIGN SYSTEM, U-CHANNEL			
0093	4158000000-N	1.000 EA	\$2.3500	\$2.35
	DISPOSAL OF SIGN SYSTEM, WOOD			
0094	4192000000-N	14.000 EA	\$2.3500	\$32.90
	DISPOSAL OF SUPPORT, U-CHANNEL			
0095	4400000000-E	1716.000 SF	\$13.9000	\$23,852.40
	WORK ZONE SIGNS (STATIONARY)			
0096	4405000000-E	180.000 SF	\$11.0000	\$1,980.00
	WORK ZONE SIGNS (PORTABLE)			
0097	4410000000-E	252.000 SF	\$9.2500	\$2,331.00

WORK ZONE SIGNS (BARRICADE MOUNTED)

0098	4420000000-N	2.000 EA	\$4,423.0000	\$8,846.00
	PORTABLE CHANGEABLE MESSAGE SIGN			
0099	4430000000-N	1500.000 EA	\$48.7500	\$73,125.00
	DRUMS			
0100	4435000000-N	500.000 EA	\$25.4500	\$12,725.00
	CONES			
0101	4445000000-E	488.000 LF	\$25.4500	\$12,419.60
	BARRICADES (TYPE III)			
0102	4455000000-N	1080.000 DAY	\$510.0000	\$550,800.00
	FLAGGER			
0103	4465000000-N	2.000 EA	\$6,159.0000	\$12,318.00
	TEMPORARY CRASH CUSHIONS			
0104	4485000000-E	120.000 LF	\$83.7500	\$10,050.00
	PORTABLE CONCRETE BARRIER			
0105	4507000000-E	500.000 LF	\$75.2500	\$37,625.00
	WATER FILLED BARRIER			
0106	4510000000-N	120.000 HR	\$112.0000	\$13,440.00
	LAW ENFORCEMENT			
0107	4650000000-N	630.000 EA	\$9.5000	\$5,985.00
	TEMPORARY RAISED PAVEMENT MARKERS			
0108	4688000000-E	50234.000 LF	\$0.7000	\$35,163.80
	THERMOPLASTIC PAVEMENT MARKING LINES (6", 90 MILS)			
0109	4700000000-E	8118.000 LF	\$1.5000	\$12,177.00
	THERMOPLASTIC PAVEMENT MARKING LINES (12", 90 MILS)			
0110	4709000000-E	785.000 LF	\$11.2000	\$8,792.00
	THERMOPLASTIC PAVEMENT MARKING LINES (24", 90 MILS)			
0111	4725000000-E	115.000 EA	\$106.0000	\$12,190.00
	THERMOPLASTIC PAVEMENT MARKING SYMBOL (90 MILS)			
0112	4810000000-E	250335.000 LF	\$0.1500	\$37,550.25
	PAINT PAVEMENT MARKING LINES (4")			
0113	4820000000-E	12220.000 LF	\$0.3000	\$3,666.00
	PAINT PAVEMENT MARKING LINES (8")			
0114	4835000000-E	1590.000 LF	\$5.8500	\$9,301.50
	PAINT PAVEMENT MARKING LINES (24")			
0115	4845000000-N	378.000 EA	\$72.7500	\$27,499.50
	PAINT PAVEMENT MARKING SYMBOL			
0116	4850000000-E	500.000 LF	\$2.2500	\$1,125.00
	REMOVAL OF PAVEMENT MARKING LINES (4")			
0117	4860000000-E	249.000 LF	\$4.4500	\$1,108.05
	REMOVAL OF PAVEMENT MARKING LINES (8")			
0118	4875000000-N	13.000 EA	\$58.0000	\$754.00
	REMOVAL OF PAVEMENT MARKING SYMBOLS & CHARACTERS			
0119	4890000000-E	100.000 LF	\$27.9500	\$2,795.00
	GENERIC PAVEMENT MARKING ITEM YIELD LINE PAINT PAVEMENT MARKING (24")			
0120	4890000000-E	40.000 LF	\$27.9500	\$1,118.00
	GENERIC PAVEMENT MARKING ITEM YIELD LINE THERMOPLASTIC PAVEMENT MARKING (24", 90MILS)			
0121	4895000000-N	1775.000 EA	\$49.7500	\$88,306.25

GENERIC PAVEMENT MARKING ITEM POLYCARBONATE H-SHAPED MARKERS

0122	5325000000-E	296.000	LF	\$191.0000	\$56,536.00
	*** WATER LINE (18")				
0123	5325600000-E	20.000	LF	\$84.2500	\$1,685.00
	6" WATER LINE				
0124	5325800000-E	323.000	LF	\$63.7500	\$20,591.25
	8" WATER LINE				
0125	5326600000-E	5063.000	LF	\$242.0000	\$1,225,246.00
	16" WATER LINE				
0126	5329000000-E	19855.000	LB	\$19.6500	\$390,150.75
	DUCTILE IRON WATER PIPE FITTINGS				
0127	5540000000-E	12.000	EA	\$3,223.0000	\$38,676.00
	6" VALVE				
0128	5546000000-E	7.000	EA	\$4,188.0000	\$29,316.00
	8" VALVE				
0129	5558600000-E	11.000	EA	\$18,613.0000	\$204,743.00
	16" VALVE				
0130	5648000000-N	68.000	EA	\$3,632.0000	\$246,976.00
	RELOCATE WATER METER				
0131	5649000000-N	11.000	EA	\$2,690.0000	\$29,590.00
	RECONNECT WATER METER				
0132	5666000000-N	11.000	EA	\$7,979.0000	\$87,769.00
	FIRE HYDRANT				
0133	5673000000-E	76.000	LF	\$111.0000	\$8,436.00
	FIRE HYDRANT LEG				
0134	5678600000-E	4.000	EA	\$16,332.0000	\$65,328.00
	8" LINE STOP				
0135	5686000000-E	197.000	LF	\$118.0000	\$23,246.00
	*** WATER SERVICE LINE (2")				
0136	5686500000-E	2339.000	LF	\$81.0000	\$189,459.00
	WATER SERVICE LINE				
0137	5768000000-N	17.000	EA	\$1,498.0000	\$25,466.00
	SANITARY SEWER CLEAN-OUT				
0138	5801000000-E	235.000	LF	\$47.6500	\$11,197.75
	ABANDON 8" UTILITY PIPE				
0139	5810000000-E	5323.000	LF	\$22.4500	\$119,501.35
	ABANDON 16" UTILITY PIPE				
0140	5815500000-N	11.000	EA	\$1,884.0000	\$20,724.00
	REMOVE FIRE HYDRANT				
0141	5872600000-E	211.000	LF	\$163.0000	\$34,393.00
	DIRECTIONAL DRILLING OF *** (18")				
0142	6000000000-E	45690.000	LF	\$3.0500	\$139,354.50
	TEMPORARY SILT FENCE				
0143	6006000000-E	1120.000	TON	\$0.0100	\$11.20
	STONE FOR EROSION CONTROL, CLASS A				
0144	6009000000-E	4010.000	TON	\$102.0000	\$409,020.00
	STONE FOR EROSION CONTROL, CLASS B				
0145	6012000000-E	3680.000	TON	\$96.2500	\$354,200.00
	SEDIMENT CONTROL STONE				

0146	6015000000-E	40.500	ACR	\$1,806.0000	\$73,143.00
	TEMPORARY MULCHING				
0147	6018000000-E	2100.000	LB	\$2.2500	\$4,725.00
	SEED FOR TEMPORARY SEEDING				
0148	6021000000-E	11.000	TON	\$960.0000	\$10,560.00
	FERTILIZER FOR TEMPORARY SEEDING				
0149	6024000000-E	585.000	LF	\$112.2500	\$65,666.25
	TEMPORARY SLOPE DRAINS				
0150	6029000000-E	1120.000	LF	\$2.8000	\$3,136.00
	SAFETY FENCE				
0151	6030000000-E	23370.000	CY	\$1.0000	\$23,370.00
	SILT EXCAVATION				
0152	6036000000-E	20500.000	SY	\$1.8000	\$36,900.00
	MATTING FOR EROSION CONTROL				
0153	6037000000-E	920.000	SY	\$7.1000	\$6,532.00
	COIR FIBER MAT				
0154	6042000000-E	10650.000	LF	\$6.7500	\$71,887.50
	1/4" HARDWARE CLOTH				
0155	6070000000-N	4.000	EA	\$1,960.0000	\$7,840.00
	SPECIAL STILLING BASINS				
0156	6071002000-E	5390.000	LB	\$8.1000	\$43,659.00
	FLOCCULANT				
0157	6071012000-E	8360.000	LF	\$9.0500	\$75,658.00
	COIR FIBER WATTLE				
0158	6071030000-E	3760.000	LF	\$7.7500	\$29,140.00
	COIR FIBER BAFFLE				
0159	6071050000-E	18.000	EA	\$5,848.0000	\$105,264.00
	*** SKIMMER (1-1/2")				
0160	6071050000-E	3.000	EA	\$6,131.0000	\$18,393.00
	*** SKIMMER (2")				
0161	6071050000-E	4.000	EA	\$6,414.0000	\$25,656.00
	*** SKIMMER (2-1/2")				
0162	6084000000-E	50.000	ACR	\$2,935.0000	\$146,750.00
	SEEDING & MULCHING				
0163	6087000000-E	27.000	ACR	\$169.0000	\$4,563.00
	MOWING				
0164	6090000000-E	450.000	LB	\$4.5000	\$2,025.00
	SEED FOR REPAIR SEEDING				
0165	6093000000-E	2.000	TON	\$1,129.0000	\$2,258.00
	FERTILIZER FOR REPAIR SEEDING				
0166	6096000000-E	725.000	LB	\$4.5000	\$3,262.50
	SEED FOR SUPPLEMENTAL SEEDING				
0167	6108000000-E	21.500	TON	\$1,016.0000	\$21,844.00
	FERTILIZER TOPDRESSING				
0168	6111000000-E	445.000	LF	\$92.0000	\$40,940.00
	IMPERVIOUS DIKE				
0169	6114500000-N	10.000	MHR	\$169.0000	\$1,690.00
	SPECIALIZED HAND MOWING				
0170	6114800000-N	15.000	MHR	\$169.0000	\$2,535.00

MANUAL LITTER REMOVAL

0171	6114900000-E	4.000 TON	\$226.0000	\$904.00
	LITTER DISPOSAL			
0172	6117000000-N	100.000 EA	\$141.0000	\$14,100.00
	RESPONSE FOR EROSION CONTROL			
0173	6117500000-N	2.000 EA	\$1,136.0000	\$2,272.00
	CONCRETE WASHOUT STRUCTURE			
0174	6120000000-E	192.000 CY	\$58.0000	\$11,136.00
	CULVERT DIVERSION CHANNEL			
0175	6123000000-E	0.100 ACR	\$28,224.0000	\$2,822.40
	REFORESTATION			
0176	6132000000-N	12.000 EA	\$1,069.0000	\$12,828.00
	GENERIC EROSION CONTROL ITEM PREFABRICATED CONCRETE WASHOUT			
0177	7048500000-E	2.000 EA	\$1,205.0000	\$2,410.00
	PEDESTRIAN SIGNAL HEAD (16", 1 SECTION W/COUNTDOWN)			
0178	7060000000-E	8970.000 LF	\$4.5500	\$40,813.50
	SIGNAL CABLE			
0179	7120000000-E	56.000 EA	\$1,417.0000	\$79,352.00
	VEHICLE SIGNAL HEAD (12", 3 SECTION)			
0180	7132000000-E	8.000 EA	\$1,688.0000	\$13,504.00
	VEHICLE SIGNAL HEAD (12", 4 SECTION)			
0181	7144000000-E	1.000 EA	\$2,039.0000	\$2,039.00
	VEHICLE SIGNAL HEAD (12", 5 SECTION)			
0182	7252000000-E	2160.000 LF	\$5.7500	\$12,420.00
	MESSENGER CABLE (1/4")			
0183	7264000000-E	3270.000 LF	\$3.5000	\$11,445.00
	MESSENGER CABLE (3/8")			
0184	7279000000-E	3770.000 LF	\$1.6000	\$6,032.00
	TRACER WIRE			
0185	7300000000-E	850.000 LF	\$12.8000	\$10,880.00
	UNPAVED TRENCHING (***** (1, 2"))			
0186	7300000000-E	2720.000 LF	\$20.3500	\$55,352.00
	UNPAVED TRENCHING (***** (2, 2"))			
0187	7300000000-E	40.000 LF	\$30.5500	\$1,222.00
	UNPAVED TRENCHING (***** (3, 2"))			
0188	7301000000-E	1427.000 LF	\$35.0500	\$50,016.35
	DIRECTIONAL DRILL (***** (2, 2"))			
0189	7312000000-N	2.000 EA	\$1,245.0000	\$2,490.00
	JUNCTION BOX (***** (SPECIAL OVER-SIZED, HEAVY DUTY)			
0190	7324000000-N	19.000 EA	\$463.0000	\$8,797.00
	JUNCTION BOX (STANDARD SIZE)			
0191	7348000000-N	17.000 EA	\$799.0000	\$13,583.00
	JUNCTION BOX (OVER-SIZED, HEAVY DUTY)			
0192	7360000000-N	13.000 EA	\$1,245.0000	\$16,185.00
	WOOD POLE			
0193	7372000000-N	34.000 EA	\$665.0000	\$22,610.00
	GUY ASSEMBLY			
0194	7408000000-E	3.000 EA	\$508.0000	\$1,524.00
	1" RISER WITH WEATHERHEAD			

0195	7420000000-E	8.000 EA	\$720.0000	\$5,760.00
	2" RISER WITH WEATHERHEAD			
0196	7432000000-E	5.000 EA	\$1,042.0000	\$5,210.00
	2" RISER WITH HEAT SHRINK TUBING			
0197	7444000000-E	600.000 LF	\$9.8500	\$5,910.00
	INDUCTIVE LOOP SAWCUT			
0198	7456100000-E	2110.000 LF	\$3.6000	\$7,596.00
	LEAD-IN CABLE (14-2)			
0199	7516000000-E	12699.000 LF	\$5.6500	\$71,749.35
	COMMUNICATIONS CABLE (** FIBER) (24)			
0200	7528000000-E	305.000 LF	\$5.6500	\$1,723.25
	DROP CABLE			
0201	7540000000-N	3.000 EA	\$2,661.0000	\$7,983.00
	SPLICE ENCLOSURE			
0202	7541000000-N	1.000 EA	\$2,332.0000	\$2,332.00
	MODIFY SPLICE ENCLOSURE			
0203	7552000000-N	4.000 EA	\$3,085.0000	\$12,340.00
	INTERCONNECT CENTER			
0204	7566000000-N	18.000 EA	\$197.0000	\$3,546.00
	DELINEATOR MARKER			
0205	7575142060-N	1.000 EA	\$1,183.0000	\$1,183.00
	MODIFY RADIO INSTALLATION			
0206	7576000000-N	9.000 EA	\$18,083.0000	\$162,747.00
	METAL STRAIN SIGNAL POLE			
0207	7613000000-N	9.000 EA	\$4,710.0000	\$42,390.00
	SOIL TEST			
0208	7614100000-E	67.500 CY	\$1,797.0000	\$121,297.50
	DRILLED PIER FOUNDATION			
0209	7636000000-N	6.000 EA	\$635.0000	\$3,810.00
	SIGN FOR SIGNALS			
0210	7642200000-N	2.000 EA	\$3,393.0000	\$6,786.00
	TYPE II PEDESTAL WITH FOUNDATION			
0211	7684000000-N	3.000 EA	\$1,134.0000	\$3,402.00
	SIGNAL CABINET FOUNDATION			
0212	7696000000-N	5.000 EA	\$26,592.0000	\$132,960.00
	CONTROLLERS WITH CABINET (***** (TYPE 2070LX, BASE MOUNTED)			
0213	7744000000-N	12.000 EA	\$260.0000	\$3,120.00
	DETECTOR CARD (TYPE 170)			
0214	7901000000-N	5.000 EA	\$619.0000	\$3,095.00
	CABINET BASE EXTENDER			
0215	7960000000-N	1.000 EA	\$2,111.0000	\$2,111.00
	METAL POLE FOUNDATION REMOVAL			
0216	7972000000-N	1.000 EA	\$855.0000	\$855.00
	METAL POLE REMOVAL			
0217	7980000000-N	3.000 EA	\$2,618.0000	\$7,854.00
	GENERIC SIGNAL ITEM ETHERNET EDGE SWITCH			
0218	7980000000-N	15.000 EA	\$16,749.0000	\$251,235.00
	GENERIC SIGNAL ITEM MICROWAVE VEHICLE DETECTION SYSTEM - MULTIPLE ZONES			

Section 0001 Total \$29,765,994.25

Section 0002
 CULVERT ITEMS

0219	8056000000-N	1.000 LS	\$58,036.0000	\$58,036.00
	REMOVAL OF EXISTING STRUCTURE AT STATION ***** (55+17.00 -L-)			
0220	8130000000-N	1.000 LS	\$175,450.0000	\$175,450.00
	BOX CULVERT EXCAVATION, STA ***** (55+17.00 -L-)			
0221	8133000000-E	355.000 TON	\$98.7500	\$35,056.25
	FOUNDATION CONDITIONING MATERIAL, BOX CULVERT			
0222	8196000000-E	594.300 CY	\$813.0000	\$483,165.90
	CLASS A CONCRETE (CULVERT)			
0223	8245000000-E	85862.000 LB	\$2.3000	\$197,482.60
	REINFORCING STEEL (CULVERT)			

Section 0002 Total \$949,190.75

Item Total \$30,715,185.00

ELECTRONIC BID SUBMISSION

By submitting this bid electronically, I hereby acknowledge that all requirements included in the hard copy proposal, addendum, amendments, plans, standard specifications, supplemental specifications and special provisions are part of the bid and contract. Further, I acknowledge that I have read, understand, accept, acknowledge and agree to comply with all statements in this electronic bid.

=====

NON-COLLUSION, DEBARMENT AND GIFT BAN CERTIFICATION

The prequalified bidder declares (or certifies, verifies, or states) under penalty of perjury under the laws of the United States that neither he, nor any official, agent or employee has entered into any agreement, participated in any collusion, or otherwise taken any action which is in restraint of free competitive bidding in connection with any bid or contract, that the prequalified bidder has not been convicted of violating N.C.G.S. §133-24 within the last three years, and that the prequalified bidder intends to do the work with his own bonafide employees or subcontractors and will not bid for the benefit of another contractor.

By submitting this non-collusion, debarment and gift ban certification, the Contractor is attesting his status under penalty of perjury under the laws of the United States in accordance with the Debarment Certification attached, provided that the Debarment Certification also includes any required statements concerning exceptions that are applicable.

N.C.G.S. §133-32 and Executive Order 24 prohibit the offer to, or acceptance by, any State Employee of any gift from anyone with a contract with the State, or from any person seeking to do business with the State. By execution of any response in this procurement, you attest, for your entire organization and its employees or agents, that you are not aware that any such gift has been offered, accepted, or promised by any employees of your organization.

DEBARMENT CERTIFICATION OF PREQUALIFIED BIDDER

Conditions for certification:

1. The prequalified bidder shall provide immediate written notice to the Department if at any time the bidder learns that his certification was erroneous when he submitted his debarment certification or explanation that is file with the Department, or has become erroneous because of changed circumstances.
2. The terms covered transaction, debarred, suspended, ineligible, lower tier

covered transaction, participant, person, primary covered transaction, principal, proposal, and voluntarily excluded, as used in this provision, have the meanings set out in the Definitions and Coverage sections of the rules implementing Executive Order 12549. A copy of the Federal Rules requiring this certification and detailing the definitions and coverages may be obtained from the Contract Officer of the Department.

3. The prequalified bidder agrees by submitting this form, that he will not knowingly enter into any lower tier covered transaction with a person who is debarred, suspended, declared ineligible, or voluntarily excluded from participation in NCDOT contracts, unless authorized by the Department.

4. For Federal Aid projects, the prequalified bidder further agrees that by submitting this form he will include the Federal- Aid Provision titled Required Contract Provisions Federal-Aid Construction Contract (Form FHWA PR 1273) provided by the Department, without subsequent modification, in all lower tier covered transactions.

5. The prequalified bidder may rely upon a certification of a participant in a lower tier covered transaction that he is not debarred, suspended, ineligible, or voluntarily excluded from the covered transaction, unless he knows that the certification is erroneous. The bidder may decide the method and frequency by which he will determine the eligibility of his subcontractors.

6. Nothing contained in the foregoing shall be construed to require establishment of a system of records in order to render in good faith the certification required by this provision. The knowledge and information of a participant is not required to exceed that which is normally possessed by a prudent person in the ordinary course of business dealings.

7. Except as authorized in paragraph 6 herein, the Department may terminate any contract if the bidder knowingly enters into a lower tier covered transaction with a person who is suspended, debarred, ineligible, or voluntarily excluded from participation in this transaction, in addition to other remedies available by the Federal Government.

DEBARMENT CERTIFICATION

The prequalified bidder certifies to the best of his knowledge and belief, that he and his principals:

a. Are not presently debarred, suspended, proposed for debarment, declared ineligible, or voluntarily excluded from covered transactions by any Federal department or agency;

b. Have not within a three-year period preceding this proposal been convicted of or had a civil judgment rendered against them for commission of fraud or a criminal offense in connection with obtaining, attempting to obtain, or performing a public (Federal, State or local) transaction or contract under a public transaction; violation of Federal or State antitrust statutes or

commission of embezzlement, theft, forgery, bribery, falsification or destruction of records; making false statements; or receiving stolen property;

c. Are not presently indicted for or otherwise criminally or civilly charged by a governmental entity (Federal, State or local) with commission of any of the offenses enumerated in paragraph b. of this certification; and

d. Have not within a three-year period preceding this proposal had one or more public transactions (Federal, State or local) terminated for cause or default.

e. Will submit a revised Debarment Certification immediately if his status changes and will show in his bid proposal an explanation for the change in status.

If the prequalified bidder cannot certify that he is not debarred, he shall provide an explanation with this submittal. An explanation will not necessarily result in denial of participation in a contract.

Failure to submit a non-collusion and debarment certification will result in the prequalified bidder's bid being considered non-responsive.

EXPLANATION:

=====

Award Limits on Multiple Projects

By answering YES to this statement, the bidder acknowledges that they are using the award limits on multiple projects? **Yes** **No**

A bidder who desires to bid on more than one project on which bids are to be opened on the same date, and who also desires to avoid receiving an award of more projects than he is equipped to handle, may bid on any number of projects but may limit the total amount of work awarded to him on selected projects by completing the AWARD LIMITS ON MULTIPLE PROJECTS.

The Award Limits on Multiple Projects must be filled in on each project bid for which the Bidder desires protection.

It is the desire of the Bidder to be awarded contracts, the value of which will not exceed a total of for those

projects indicated herein, for which bids will be opened on (MM/DD/YY)

The Award Limits shall apply to the following projects:

Contract Number
County

Contract Number
County

Contract Number
County

Contract Number
County

Contract Number
County

Contract Number
County

It is agreed that if I am (we are) the low Bidder(s) on indicated projects, the total value of which is more than the above stipulated award limits, the Board of Transportation will award me (us) projects from among those indicated

that have a total value not to exceed the award limit and will result in the lowest total bids to the Department of Transportation.

THIS PROPOSAL CONTAINS THE FOLLOWING ERRORS/WARNINGS (IF ANY)

This Bid contains 0 amendment files

Electronic Bid Submission

By submitting this bid electronically, I hereby acknowledge that all requirements included in the hard copy proposal, addendum, amendments, plans, standard specifications, supplemental specifications and special provisions are part of the bid and contract. Further, I acknowledge that I have read, understand, accept, acknowledge and agree to comply with all statements in this electronic bid.

I hereby certify that I have the authority to submit this bid.

Signature _____

Agency _____

Date _____

Signature _____

Agency _____

Date _____

Signature _____

Agency _____

Date _____

Attachments

Failure to complete and attach the Fuel Usage Factor Adjustment Form will result in using 2.90 gallons per ton as the Fuel Usage Factor for Diesel for the asphalt items included on the form. The contractor will not be permitted to change the option after the bids are submitted.

NOTE: The maximum upload limit is 5 MB.

Verify

Line #	ItemNumber	Sec #	Description	Quantity Unit	Unit Bid Price	Amount Bid
ROADWAY ITEMS						
0001	0000100000-N	800	MOBILIZATION	LUMP SUM	1,380,830.00	1,380,830.00
0002	0000400000-N	801	CONSTRUCTION SURVEYING	LUMP SUM	313,490.00	313,490.00
0003	0050000000-E	226	SUPPLEMENTARY CLEARING & GRUBBING	1 ACR	11,177.00	11,177.00
0004	0057000000-E	226	UNDERCUT EXCAVATION	2,350 CY	22.45	52,757.50
0005	0063000000-N	SP	GRADING	LUMP SUM	1,628,381.84	1,628,381.84
0006	0106000000-E	230	BORROW EXCAVATION	61,400 CY	25.50	1,565,700.00
0007	0134000000-E	240	DRAINAGE DITCH EXCAVATION	200 CY	31.05	6,210.00
0008	0195000000-E	265	SELECT GRANULAR MATERIAL	2,350 CY	25.50	59,925.00
0009	0196000000-E	270	GEOTEXTILE FOR SOIL STABILIZATION	3,750 SY	3.50	13,125.00
0010	0199000000-E	SP	TEMPORARY SHORING	450 SF	130.00	58,500.00
0011	0255000000-E	SP	GENERIC GRADING ITEM HAULING AND DISPOSAL OF PETROLEUM CONTAMINATED SOIL	60 TON	89.50	5,370.00
0012	0318000000-E	300	FOUNDATION CONDITIONING MATERIAL, MINOR STRUCTURES	2,360 TON	86.50	204,140.00
0013	0321000000-E	300	FOUNDATION CONDITIONING GEOTEXTILE	7,400 SY	2.65	19,610.00
0014	0342000000-E	310	*** SIDE DRAIN PIPE (54")	44 LF	242.00	10,648.00
0015	0343000000-E	310	15" SIDE DRAIN PIPE	838 LF	65.50	54,889.00
0016	0372000000-E	310	18" RC PIPE CULVERTS, CLASS III	18 LF	155.00	2,790.00
0017	0378000000-E	310	24" RC PIPE CULVERTS, CLASS III	96 LF	141.00	13,536.00
0018	0390000000-E	310	36" RC PIPE CULVERTS, CLASS III	48 LF	258.00	12,384.00
0019	0396000000-E	310	42" RC PIPE CULVERTS, CLASS III	16 LF	511.00	8,176.00
0020	0448000000-E	310	***** RC PIPE CULVERTS, CLASS IV (54")	228 LF	725.00	165,300.00
0021	0448200000-E	310	15" RC PIPE CULVERTS, CLASS IV	10,726 LF	93.75	1,005,562.50
0022	0448300000-E	310	18" RC PIPE CULVERTS, CLASS IV	1,452 LF	110.00	159,720.00

Line #	ItemNumber	Sec #	Description	Quantity Unit	Unit Bid Price	Amount Bid
ROADWAY ITEMS						
0023	0448400000-E	310	24" RC PIPE CULVERTS, CLASS IV	3,744 LF	164.00	614,016.00
0024	0448500000-E	310	30" RC PIPE CULVERTS, CLASS IV	1,816 LF	230.00	417,680.00
0025	0448600000-E	310	36" RC PIPE CULVERTS, CLASS IV	2,796 LF	309.00	863,964.00
0026	0448700000-E	310	42" RC PIPE CULVERTS, CLASS IV	112 LF	454.00	50,848.00
0027	0449000000-E	310	*** RC PIPE CULVERTS, CLASS V (15")	64 LF	116.00	7,424.00
0028	0449000000-E	310	*** RC PIPE CULVERTS, CLASS V (54")	176 LF	846.00	148,896.00
0029	0995000000-E	340	PIPE REMOVAL	5,507 LF	47.00	258,829.00
0030	0996000000-N	350	PIPE CLEAN OUT	2 EA	29,985.00	59,970.00
0031	1099500000-E	505	SHALLOW UNDERCUT	3,750 CY	20.40	76,500.00
0032	1099700000-E	505	CLASS IV SUBGRADE STABILIZATION	9,075 TON	55.00	499,125.00
0033	1111000000-E	SP	CLASS IV AGGREGATE STABILIZATION	300 TON	55.00	16,500.00
0034	1112000000-E	505	GEOTEXTILE FOR SUBGRADE STABILIZATION	13,575 SY	4.45	60,408.75
0035	1220000000-E	545	INCIDENTAL STONE BASE	1,000 TON	61.50	61,500.00
0036	1297000000-E	607	MILLING ASPHALT PAVEMENT, **** DEPTH (2-1/2")	46,075 SY	2.70	124,402.50
0037	1330000000-E	607	INCIDENTAL MILLING	4,400 SY	8.40	36,960.00
0038	1491000000-E	610	ASPHALT CONC BASE COURSE, TYPE B25.0C	21,100 TON	93.00	1,962,300.00
0039	1503000000-E	610	ASPHALT CONC INTERMEDIATE COURSE, TYPE I19.0C	26,500 TON	93.00	2,464,500.00
0040	1519000000-E	610	ASPHALT CONC SURFACE COURSE, TYPE S9.5B	1,800 TON	146.00	262,800.00
0041	1523000000-E	610	ASPHALT CONC SURFACE COURSE, TYPE S9.5C	19,000 TON	106.00	2,014,000.00
0042	1575000000-E	620	ASPHALT BINDER FOR PLANT MIX	3,460 TON	598.00	2,069,080.00
0043	1693000000-E	654	ASPHALT PLANT MIX, PAVEMENT REPAIR	500 TON	266.00	133,000.00
0044	1880000000-E	SP	GENERIC PAVING ITEM JOINT REPAIR	200 TON	447.00	89,400.00

Line #	ItemNumber	Sec #	Description	Quantity Unit	Unit Bid Price	Amount Bid
ROADWAY ITEMS						
0045	2022000000-E	815	SUBDRAIN EXCAVATION	807 CY	32.20	25,985.40
0046	2026000000-E	815	GEOTEXTILE FOR SUBSURFACE DRAINS	3,600 SY	5.90	21,240.00
0047	2036000000-E	815	SUBDRAIN COARSE AGGREGATE	605 CY	137.00	82,885.00
0048	2044000000-E	815	6" PERFORATED SUBDRAIN PIPE	3,600 LF	13.75	49,500.00
0049	2070000000-N	815	SUBDRAIN PIPE OUTLET	8 EA	1,271.00	10,168.00
0050	2077000000-E	815	6" OUTLET PIPE	48 LF	105.00	5,040.00
0051	2209000000-E	838	ENDWALLS	29.3 CY	1,946.00	57,017.80
0052	2220000000-E	838	REINFORCED ENDWALLS	17.1 CY	3,761.00	64,313.10
0053	2253000000-E	840	PIPE COLLARS	0.89 CY	7,743.00	6,914.50
0054	2275000000-E	SP	FLOWABLE FILL	13 CY	1,241.00	16,133.00
0055	2286000000-N	840	MASONRY DRAINAGE STRUCTURES	196 EA	3,725.00	730,100.00
0056	2297000000-E	840	MASONRY DRAINAGE STRUCTURES	6.72 CY	8,690.00	58,370.73
0057	2308000000-E	840	MASONRY DRAINAGE STRUCTURES	22.6 LF	1,502.00	33,945.20
0058	2364000000-N	840	FRAME WITH TWO GRATES, STD 840.16	36 EA	1,935.00	69,660.00
0059	2366000000-N	840	FRAME WITH TWO GRATES, STD 840.24	1 EA	1,740.00	1,740.00
0060	2367000000-N	840	FRAME WITH TWO GRATES, STD 840.29	2 EA	1,777.00	3,554.00
0061	2374000000-N	840	FRAME WITH GRATE & HOOD, STD 840.03, TYPE ** (E)	27 EA	2,044.00	55,188.00
0062	2374000000-N	840	FRAME WITH GRATE & HOOD, STD 840.03, TYPE ** (F)	73 EA	2,106.00	153,738.00
0063	2374000000-N	840	FRAME WITH GRATE & HOOD, STD 840.03, TYPE ** (G)	61 EA	2,106.00	128,466.00
0064	2396000000-N	840	FRAME WITH COVER, STD 840.54	5 EA	1,269.00	6,345.00
0065	2440000000-N	852	CONCRETE TRANSITIONAL SECTION FOR CATCH BASIN	15 EA	1,248.00	18,720.00

Line #	ItemNumber	Sec #	Description	Quantity Unit	Unit Bid Price	Amount Bid
ROADWAY ITEMS						
0066	2451000000-N	852	CONCRETE TRANSITIONAL SECTION FOR DROP INLET	9 EA	1,248.00	11,232.00
0067	2535000000-E	846	*** X *** CONCRETE CURB (8" X 12")	770 LF	31.10	23,947.00
0068	2542000000-E	846	1'-6" CONCRETE CURB & GUTTER	6,700 LF	31.10	208,370.00
0069	2549000000-E	846	2'-6" CONCRETE CURB & GUTTER	23,550 LF	36.70	864,285.00
0070	2591000000-E	848	4" CONCRETE SIDEWALK	2,900 SY	64.00	185,600.00
0071	2605000000-N	848	CONCRETE CURB RAMPS	17 EA	2,837.00	48,229.00
0072	2612000000-E	848	6" CONCRETE DRIVEWAY	3,120 SY	87.75	273,780.00
0073	2655000000-E	852	5" MONOLITHIC CONCRETE ISLANDS (KEYED IN)	5,925 SY	87.75	519,918.75
0074	2830000000-N	858	ADJUSTMENT OF MANHOLES	1 EA	384.00	384.00
0075	3030000000-E	862	STEEL BEAM GUARDRAIL	412.5 LF	42.25	17,428.13
0076	3105000000-N	862	STEEL BEAM GUARDRAIL TERMINAL SECTIONS	2 EA	112.00	224.00
0077	3150000000-N	862	ADDITIONAL GUARDRAIL POSTS	5 EA	49.20	246.00
0078	3210000000-N	862	GUARDRAIL END UNITS, TYPE CAT-1	2 EA	1,062.00	2,124.00
0079	3287000000-N	862	GUARDRAIL END UNITS, TYPE TL-3	2 EA	3,744.00	7,488.00
0080	3360000000-E	863	REMOVE EXISTING GUARDRAIL	400 LF	1.10	440.00
0081	3628000000-E	876	RIP RAP, CLASS I	410 TON	127.00	52,070.00
0082	3649000000-E	876	RIP RAP, CLASS B	150 TON	109.00	16,350.00
0083	3656000000-E	876	GEOTEXTILE FOR DRAINAGE	2,900 SY	4.35	12,615.00
0084	4072000000-E	903	SUPPORTS, 3-LB STEEL U-CHANNEL	3,185 LF	10.70	34,079.50
0085	4096000000-N	904	SIGN ERECTION, TYPE D	1 EA	178.00	178.00
0086	4102000000-N	904	SIGN ERECTION, TYPE E	119 EA	88.75	10,561.25
0087	4108000000-N	904	SIGN ERECTION, TYPE F	22 EA	118.00	2,596.00

Line #	ItemNumber	Sec #	Description	Quantity Unit	Unit Bid Price	Amount Bid
ROADWAY ITEMS						
0088	4116100000-N	904	SIGN ERECTION, RELOCATE TYPE **** (GROUND MOUNTED) (D)	5 EA	178.00	890.00
0089	4116100000-N	904	SIGN ERECTION, RELOCATE TYPE **** (GROUND MOUNTED) (E)	8 EA	178.00	1,424.00
0090	4116100000-N	904	SIGN ERECTION, RELOCATE TYPE **** (GROUND MOUNTED) (F)	1 EA	178.00	178.00
0091	4141000000-N	907	DISPOSAL OF SUPPORT, WOOD	1 EA	59.25	59.25
0092	4155000000-N	907	DISPOSAL OF SIGN SYSTEM, U- CHANNEL	53 EA	2.35	124.55
0093	4158000000-N	907	DISPOSAL OF SIGN SYSTEM, WOOD	1 EA	2.35	2.35
0094	4192000000-N	907	DISPOSAL OF SUPPORT, U-CHANNEL	14 EA	2.35	32.90
0095	4400000000-E	1110	WORK ZONE SIGNS (STATIONARY)	1,716 SF	13.90	23,852.40
0096	4405000000-E	1110	WORK ZONE SIGNS (PORTABLE)	180 SF	11.00	1,980.00
0097	4410000000-E	1110	WORK ZONE SIGNS (BARRICADE MOUNTED)	252 SF	9.25	2,331.00
0098	4420000000-N	1120	PORTABLE CHANGEABLE MESSAGE SIGN	2 EA	4,423.00	8,846.00
0099	4430000000-N	1130	DRUMS	1,500 EA	48.75	73,125.00
0100	4435000000-N	1135	CONES	500 EA	25.45	12,725.00
0101	4445000000-E	1145	BARRICADES (TYPE III)	488 LF	25.45	12,419.60
0102	4455000000-N	1150	FLAGGER	1,080 DAY	510.00	550,800.00
0103	4465000000-N	1160	TEMPORARY CRASH CUSHIONS	2 EA	6,159.00	12,318.00
0104	4485000000-E	1170	PORTABLE CONCRETE BARRIER	120 LF	83.75	10,050.00
0105	4507000000-E	1170	WATER FILLED BARRIER	500 LF	75.25	37,625.00
0106	4510000000-N	1190	LAW ENFORCEMENT	120 HR	112.00	13,440.00
0107	4650000000-N	1251	TEMPORARY RAISED PAVEMENT MARKERS	630 EA	9.50	5,985.00
0108	4688000000-E	1205	THERMOPLASTIC PAVEMENT MARKING LINES (6", 90 MILS)	50,234 LF	0.70	35,163.80

Line #	ItemNumber	Sec #	Description	Quantity Unit	Unit Bid Price	Amount Bid
ROADWAY ITEMS						
0109	4700000000-E	1205	THERMOPLASTIC PAVEMENT MARKING LINES (12", 90 MILS)	8,118 LF	1.50	12,177.00
0110	4709000000-E	1205	THERMOPLASTIC PAVEMENT MARKING LINES (24", 90 MILS)	785 LF	11.20	8,792.00
0111	4725000000-E	1205	THERMOPLASTIC PAVEMENT MARKING SYMBOL (90 MILS)	115 EA	106.00	12,190.00
0112	4810000000-E	1205	PAINT PAVEMENT MARKING LINES (4")	250,335 LF	0.15	37,550.25
0113	4820000000-E	1205	PAINT PAVEMENT MARKING LINES (8")	12,220 LF	0.30	3,666.00
0114	4835000000-E	1205	PAINT PAVEMENT MARKING LINES (24")	1,590 LF	5.85	9,301.50
0115	4845000000-N	1205	PAINT PAVEMENT MARKING SYMBOL	378 EA	72.75	27,499.50
0116	4850000000-E	1205	REMOVAL OF PAVEMENT MARKING LINES (4")	500 LF	2.25	1,125.00
0117	4860000000-E	1205	REMOVAL OF PAVEMENT MARKING LINES (8")	249 LF	4.45	1,108.05
0118	4875000000-N	1205	REMOVAL OF PAVEMENT MARKING SYMBOLS & CHARACTERS	13 EA	58.00	754.00
0119	4890000000-E	SP	GENERIC PAVEMENT MARKING ITEM YIELD LINE PAINT PAVEMENT MARKING (24")	100 LF	27.95	2,795.00
0120	4890000000-E	SP	GENERIC PAVEMENT MARKING ITEM YIELD LINE THERMOPLASTIC PAVEMENT MARKING (24", 90MILS)	40 LF	27.95	1,118.00
0121	4895000000-N	SP	GENERIC PAVEMENT MARKING ITEM POLYCARBONATE H-SHAPED MARKERS	1,775 EA	49.75	88,306.25
0122	5325000000-E	1510	*** WATER LINE (18")	296 LF	191.00	56,536.00
0123	5325600000-E	1510	6" WATER LINE	20 LF	84.25	1,685.00
0124	5325800000-E	1510	8" WATER LINE	323 LF	63.75	20,591.25
0125	5326600000-E	1510	16" WATER LINE	5,063 LF	242.00	1,225,246.00
0126	5329000000-E	1510	DUCTILE IRON WATER PIPE FITTINGS	19,855 LB	19.65	390,150.75
0127	5540000000-E	1515	6" VALVE	12 EA	3,223.00	38,676.00
0128	5546000000-E	1515	8" VALVE	7 EA	4,188.00	29,316.00
0129	5558600000-E	1515	16" VALVE	11 EA	18,613.00	204,743.00

Line #	ItemNumber	Sec #	Description	Quantity Unit	Unit Bid Price	Amount Bid
ROADWAY ITEMS						
0130	5648000000-N	1515	RELOCATE WATER METER	68 EA	3,632.00	246,976.00
0131	5649000000-N	1515	RECONNECT WATER METER	11 EA	2,690.00	29,590.00
0132	5666000000-N	1515	FIRE HYDRANT	11 EA	7,979.00	87,769.00
0133	5673000000-E	1515	FIRE HYDRANT LEG	76 LF	111.00	8,436.00
0134	5678600000-E	1515	8" LINE STOP	4 EA	16,332.00	65,328.00
0135	5686000000-E	1515	*** WATER SERVICE LINE (2")	197 LF	118.00	23,246.00
0136	5686500000-E	1515	WATER SERVICE LINE	2,339 LF	81.00	189,459.00
0137	5768000000-N	1520	SANITARY SEWER CLEAN-OUT	17 EA	1,498.00	25,466.00
0138	5801000000-E	1530	ABANDON 8" UTILITY PIPE	235 LF	47.65	11,197.75
0139	5810000000-E	1530	ABANDON 16" UTILITY PIPE	5,323 LF	22.45	119,501.35
0140	5815500000-N	1530	REMOVE FIRE HYDRANT	11 EA	1,884.00	20,724.00
0141	5872600000-E	1550	DIRECTIONAL DRILLING OF *** (18")	211 LF	163.00	34,393.00
0142	6000000000-E	1605	TEMPORARY SILT FENCE	45,690 LF	3.05	139,354.50
0143	6006000000-E	1610	STONE FOR EROSION CONTROL, CLASS A	1,120 TON	0.01	11.20
0144	6009000000-E	1610	STONE FOR EROSION CONTROL, CLASS B	4,010 TON	102.00	409,020.00
0145	6012000000-E	1610	SEDIMENT CONTROL STONE	3,680 TON	96.25	354,200.00
0146	6015000000-E	1615	TEMPORARY MULCHING	40.5 ACR	1,806.00	73,143.00
0147	6018000000-E	1620	SEED FOR TEMPORARY SEEDING	2,100 LB	2.25	4,725.00
0148	6021000000-E	1620	FERTILIZER FOR TEMPORARY SEEDING	11 TON	960.00	10,560.00
0149	6024000000-E	1622	TEMPORARY SLOPE DRAINS	585 LF	112.25	65,666.25
0150	6029000000-E	SP	SAFETY FENCE	1,120 LF	2.80	3,136.00
0151	6030000000-E	1630	SILT EXCAVATION	23,370 CY	1.00	23,370.00

Line #	ItemNumber	Sec #	Description	Quantity Unit	Unit Bid Price	Amount Bid
ROADWAY ITEMS						
0152	6036000000-E	1631	MATTING FOR EROSION CONTROL	20,500 SY	1.80	36,900.00
0153	6037000000-E	1629	COIR FIBER MAT	920 SY	7.10	6,532.00
0154	6042000000-E	1632	1/4" HARDWARE CLOTH	10,650 LF	6.75	71,887.50
0155	6070000000-N	1639	SPECIAL STILLING BASINS	4 EA	1,960.00	7,840.00
0156	6071002000-E	1642	FLOCCULANT	5,390 LB	8.10	43,659.00
0157	6071012000-E	1642	COIR FIBER WATTLE	8,360 LF	9.05	75,658.00
0158	6071030000-E	1640	COIR FIBER BAFFLE	3,760 LF	7.75	29,140.00
0159	6071050000-E	1644	*** SKIMMER (1-1/2")	18 EA	5,848.00	105,264.00
0160	6071050000-E	1644	*** SKIMMER (2")	3 EA	6,131.00	18,393.00
0161	6071050000-E	1644	*** SKIMMER (2-1/2")	4 EA	6,414.00	25,656.00
0162	6084000000-E	1660	SEEDING & MULCHING	50 ACR	2,935.00	146,750.00
0163	6087000000-E	1660	MOWING	27 ACR	169.00	4,563.00
0164	6090000000-E	1661	SEED FOR REPAIR SEEDING	450 LB	4.50	2,025.00
0165	6093000000-E	1661	FERTILIZER FOR REPAIR SEEDING	2 TON	1,129.00	2,258.00
0166	6096000000-E	1662	SEED FOR SUPPLEMENTAL SEEDING	725 LB	4.50	3,262.50
0167	6108000000-E	1665	FERTILIZER TOPDRESSING	21.5 TON	1,016.00	21,844.00
0168	6111000000-E	SP	IMPERVIOUS DIKE	445 LF	92.00	40,940.00
0169	6114500000-N	1667	SPECIALIZED HAND MOWING	10 MHR	169.00	1,690.00
0170	6114800000-N	SP	MANUAL LITTER REMOVAL	15 MHR	169.00	2,535.00
0171	6114900000-E	SP	LITTER DISPOSAL	4 TON	226.00	904.00
0172	6117000000-N	1675	RESPONSE FOR EROSION CONTROL	100 EA	141.00	14,100.00
0173	6117500000-N	SP	CONCRETE WASHOUT STRUCTURE	2 EA	1,136.00	2,272.00

Line #	ItemNumber	Sec #	Description	Quantity Unit	Unit Bid Price	Amount Bid
ROADWAY ITEMS						
0174	612000000-E	SP	CULVERT DIVERSION CHANNEL	192 CY	58.00	11,136.00
0175	612300000-E	1670	REFORESTATION	0.1 ACR	28,224.00	2,822.40
0176	613200000-N	SP	GENERIC EROSION CONTROL ITEM PREFABRICATED CONCRETE WASHOUT	12 EA	1,069.00	12,828.00
0177	704850000-E	1705	PEDESTRIAN SIGNAL HEAD (16", 1 SECTION W/COUNTDOWN)	2 EA	1,205.00	2,410.00
0178	706000000-E	1705	SIGNAL CABLE	8,970 LF	4.55	40,813.50
0179	712000000-E	1705	VEHICLE SIGNAL HEAD (12", 3 SECTION)	56 EA	1,417.00	79,352.00
0180	713200000-E	1705	VEHICLE SIGNAL HEAD (12", 4 SECTION)	8 EA	1,688.00	13,504.00
0181	714400000-E	1705	VEHICLE SIGNAL HEAD (12", 5 SECTION)	1 EA	2,039.00	2,039.00
0182	725200000-E	1710	MESSENGER CABLE (1/4")	2,160 LF	5.75	12,420.00
0183	726400000-E	1710	MESSENGER CABLE (3/8")	3,270 LF	3.50	11,445.00
0184	727900000-E	1715	TRACER WIRE	3,770 LF	1.60	6,032.00
0185	730000000-E	1715	UNPAVED TRENCHING (***** (1, 2")	850 LF	12.80	10,880.00
0186	730000000-E	1715	UNPAVED TRENCHING (***** (2, 2")	2,720 LF	20.35	55,352.00
0187	730000000-E	1715	UNPAVED TRENCHING (***** (3, 2")	40 LF	30.55	1,222.00
0188	730100000-E	1715	DIRECTIONAL DRILL (***** (2, 2")	1,427 LF	35.05	50,016.35
0189	731200000-N	1716	JUNCTION BOX (***** (SPECIAL OVER-SIZED, HEAVY DUTY)	2 EA	1,245.00	2,490.00
0190	732400000-N	1716	JUNCTION BOX (STANDARD SIZE)	19 EA	463.00	8,797.00
0191	734800000-N	1716	JUNCTION BOX (OVER-SIZED, HEAVY DUTY)	17 EA	799.00	13,583.00
0192	736000000-N	1720	WOOD POLE	13 EA	1,245.00	16,185.00
0193	737200000-N	1721	GUY ASSEMBLY	34 EA	665.00	22,610.00
0194	740800000-E	1722	1" RISER WITH WEATHERHEAD	3 EA	508.00	1,524.00
0195	742000000-E	1722	2" RISER WITH WEATHERHEAD	8 EA	720.00	5,760.00

Line #	ItemNumber	Sec #	Description	Quantity Unit	Unit Bid Price	Amount Bid
ROADWAY ITEMS						
0196	7432000000-E	1722	2" RISER WITH HEAT SHRINK TUBING	5 EA	1,042.00	5,210.00
0197	7444000000-E	1725	INDUCTIVE LOOP SAWCUT	600 LF	9.85	5,910.00
0198	7456100000-E	1726	LEAD-IN CABLE (14-2)	2,110 LF	3.60	7,596.00
0199	7516000000-E	1730	COMMUNICATIONS CABLE (** FIBER) (24)	12,699 LF	5.65	71,749.35
0200	7528000000-E	1730	DROP CABLE	305 LF	5.65	1,723.25
0201	7540000000-N	1731	SPLICE ENCLOSURE	3 EA	2,661.00	7,983.00
0202	7541000000-N	1731	MODIFY SPLICE ENCLOSURE	1 EA	2,332.00	2,332.00
0203	7552000000-N	1731	INTERCONNECT CENTER	4 EA	3,085.00	12,340.00
0204	7566000000-N	1733	DELINEATOR MARKER	18 EA	197.00	3,546.00
0205	7575142060-N	1737	MODIFY RADIO INSTALLATION	1 EA	1,183.00	1,183.00
0206	7576000000-N	SP	METAL STRAIN SIGNAL POLE	9 EA	18,083.00	162,747.00
0207	7613000000-N	SP	SOIL TEST	9 EA	4,710.00	42,390.00
0208	7614100000-E	SP	DRILLED PIER FOUNDATION	67.5 CY	1,797.00	121,297.50
0209	7636000000-N	1745	SIGN FOR SIGNALS	6 EA	635.00	3,810.00
0210	7642200000-N	1743	TYPE II PEDESTAL WITH FOUNDATION	2 EA	3,393.00	6,786.00
0211	7684000000-N	1750	SIGNAL CABINET FOUNDATION	3 EA	1,134.00	3,402.00
0212	7696000000-N	1751	CONTROLLERS WITH CABINET (*****) (TYPE 2070LX, BASE MOUNTED)	5 EA	26,592.00	132,960.00
0213	7744000000-N	1751	DETECTOR CARD (TYPE 170)	12 EA	260.00	3,120.00
0214	7901000000-N	1753	CABINET BASE EXTENDER	5 EA	619.00	3,095.00
0215	7960000000-N	SP	METAL POLE FOUNDATION REMOVAL	1 EA	2,111.00	2,111.00
0216	7972000000-N	SP	METAL POLE REMOVAL	1 EA	855.00	855.00
0217	7980000000-N	SP	GENERIC SIGNAL ITEM ETHERNET EDGE SWITCH	3 EA	2,618.00	7,854.00

Line #	ItemNumber	Sec #	Description	Quantity Unit	Unit Bid Price	Amount Bid
ROADWAY ITEMS						
0218	7980000000-N	SP	GENERIC SIGNAL ITEM MICROWAVE VEHICLE DETECTION SYSTEM - MULTIPLE ZONES	15 EA	16,749.00	251,235.00

Line #	ItemNumber	Sec #	Description	Quantity Unit	Unit Bid Price	Amount Bid
CULVERT ITEMS						
0219	8056000000-N	402	REMOVAL OF EXISTING STRUCTURE AT STATION ***** (55+17.00 -L-)	LUMP SUM	58,036.00	58,036.00
0220	8130000000-N	414	BOX CULVERT EXCAVATION, STA ***** (55+17.00 -L-)	LUMP SUM	175,450.00	175,450.00
0221	8133000000-E	414	FOUNDATION CONDITIONING MATERIAL, BOX CULVERT	355 TON	98.75	35,056.25
0222	8196000000-E	420	CLASS A CONCRETE (CULVERT)	594.3 CY	813.00	483,165.90
0223	8245000000-E	425	REINFORCING STEEL (CULVERT)	85,862 LB	2.30	197,482.60
TOTAL AMOUNT OF BID FOR ENTIRE PROJECT						\$30,715,185.00

Contract No. **C205035**
County Wayne

Rev. 10-31-24

**EXECUTION OF CONTRACT
NON-COLLUSION, DEBARMENT AND GIFT BAN CERTIFICATION**

CORPORATION

The Contractor declares (or certifies, verifies, or states) under penalty of perjury under the laws of the United States that neither he, nor any official, agent or employee has entered into any agreement, participated in any collusion, or otherwise taken any action which is in restraint of free competitive bidding in connection with this Contract, that the Contractor has not been convicted of violating N.C.G.S. § 133-24 within the last three years, and that the Contractor intends to do the work with its own bona fide employees or subcontractors and did not bid for the benefit of another contractor.

By submitting this Execution of Contract, non-collusion, debarment and gift ban certification, the Contractor is certifying his status under penalty of perjury under the laws of the United States in accordance with the Debarment Certification attached, provided that the Debarment Certification also includes any required statements concerning exceptions that are applicable.

N.C.G.S. § 133-32 and Executive Order 24 prohibit the offer to, or acceptance by, any State Employee of any gift from anyone with a contract with the State, or from any person seeking to do business with the State. By execution of any response in this procurement, you attest, for your entire organization and its employees or agents, that you are not aware that any such gift has been offered, accepted, or promised by any employees of your organization.

SIGNATURE OF CONTRACTOR

Branch Civil, Inc

Full name of Corporation

3635 Peters Creek Road, Roanoke, VA 24019

Address as prequalified

Attest 

Signature of Secretary, Assistant Secretary
Select appropriate title

Jeffrey M. Bourne

Print or type Signer's name

By 

Signature of President, Vice President, Assistant Vice President
Select appropriate title

BRIAN J QUINLAN

Print or type Signer's name



DEBARMENT CERTIFICATION

Conditions for certification:

1. The prequalified bidder shall provide immediate written notice to the Department if at any time the bidder learns that his certification was erroneous when he submitted his debarment certification or explanation filed with the Department, or has become erroneous because of changed circumstances.
2. The terms *covered transaction, debarred, suspended, ineligible, lower tier covered transaction, participant, person, primary covered transaction, principal, proposal, and voluntarily excluded*, as used in this provision, have the meanings set out in the Definitions and Coverage sections of the rules implementing Executive Order 12549. A copy of the Federal Rules requiring this certification and detailing the definitions and coverages may be obtained from the Contract Officer of the Department.
3. The prequalified bidder agrees by submitting this form, that he will not knowingly enter into any lower tier covered transaction with a person who is debarred, suspended, declared ineligible, or voluntarily excluded from participation in NCDOT contracts, unless authorized by the Department.
4. For Federal Aid projects, the prequalified bidder further agrees that by submitting this form he will include the Federal-Aid Provision titled *Required Contract Provisions Federal-Aid Construction Contract (Form FHWA PR 1273)* provided by the Department, without subsequent modification, in all lower tier covered transactions.
5. The prequalified bidder may rely upon a certification of a participant in a lower tier covered transaction that he is not debarred, suspended, ineligible, or voluntarily excluded from the covered transaction, unless he knows that the certification is erroneous. The bidder may decide the method and frequency by which he will determine the eligibility of his subcontractors.
6. Nothing contained in the foregoing shall be construed to require establishment of a system of records in order to render in good faith the certification required by this provision. The knowledge and information of a participant is not required to exceed that which is normally possessed by a prudent person in the ordinary course of business dealings.
7. Except as authorized in paragraph 6 herein, the Department may terminate any contract if the bidder knowingly enters into a lower tier covered transaction with a person who is suspended, debarred, ineligible, or voluntarily excluded from participation in this transaction, in addition to other remedies available by the Federal Government.

DEBARMENT CERTIFICATION

The prequalified bidder certifies to the best of his knowledge and belief, that he and his principals:

- a. Are not presently debarred, suspended, proposed for debarment, declared ineligible, or voluntarily excluded from covered transactions by any Federal department or agency;
- b. Have not within a three-year period preceding this proposal been convicted of or had a civil judgment rendered against them for commission of fraud or a criminal offense in connection with obtaining, attempting to obtain, or performing a public (Federal, State or local) transaction or contract under a public transaction; violation of Federal or State antitrust statutes or commission of embezzlement, theft, forgery, bribery, falsification or destruction of records; making false statements; or receiving stolen property;
- c. Are not presently indicted for or otherwise criminally or civilly charged by a governmental entity (Federal, State or local) with commission of any of the offenses enumerated in paragraph b. of this certification; and
- d. Have not within a three-year period preceding this proposal had one or more public transactions (Federal, State or local) terminated for cause or default.
- e. Will submit a revised Debarment Certification immediately if his status changes and will show in his bid proposal an explanation for the change in status.

If the prequalified bidder cannot certify that he is not debarred, he shall provide an explanation with this submittal. An explanation will not necessarily result in denial of participation in a contract.

Failure to submit a non-collusion and debarment certification will result in the prequalified bidder's bid being considered non-responsive.

Check here if an explanation is attached to this certification.

Contract No. **C205035**

County (ies): **Wayne**

ACCEPTED BY THE
DEPARTMENT OF TRANSPORTATION

Signed by:

Ronald E. Davenport, Jr.

52C46046381F443...

Contract Officer

03/31/2026

Date

Execution of Contract and Bonds
Approved as to Form:

Signed by:

Alan

8BD7716388C4431...

Attorney General

03/31/2026

Date

Signature Sheet (Bid - Acceptance by Department)

Contract No. C205035
County Wayne

Rev. 10-31-24

Bond Numbers:
Hartford Fire Insurance Company - 44BCSJK9419
Berkshire Hathaway Specialty Insurance Company - 47-SUR-300171-01-0103

CONTRACT PAYMENT BOND

Date of Payment Bond Execution March 4, 2026

Name of Principal Contractor Branch Civil, Inc.
Hartford Fire Insurance Company, One Hartford Plaza, Hartford, CT 06155

Name of Surety: Berkshire Hathaway Specialty Insurance Company, 1314 Douglas Street, Suite 1400, Omaha, NE 68102

Name of Contracting Body: North Carolina Department of Transportation
Raleigh, North Carolina
Thirty Million Seven Hundred Fifteen Thousand One Hundred Eighty-Five and 00/100 (\$30,715,185.00)

Amount of Bond:

Contract ID No.: C205035

County Name: Wayne

KNOW ALL MEN BY THESE PRESENTS, That we, the PRINCIPAL CONTRACTOR (hereafter, PRINCIPAL) and SURETY above named, are held and firmly bound unto the above named Contracting Body, hereinafter called the Contracting Body, in the penal sum of the amount stated above for the payment of which sum well and truly to be made, we bind ourselves, our heirs, executors, administrators, and successors, jointly and severally, firmly by these presents.

THE CONDITION OF THIS OBLIGATION IS SUCH, that whereas the principal entered into a certain contract with the Contracting Body, numbered as shown above and hereto attached:

NOW THEREFORE, if the principal shall promptly make payment to all persons supplying labor and material in the prosecution of the work provided for in said contract, and any and all duly authorized modifications of said contract that may hereafter be made, notice of which modifications to the surety being hereby waived, then this obligation to be void; otherwise to remain in full force and virtue.

IN WITNESS WHEREOF, the above-bound parties have executed this instrument under their several seals on the date indicated above, the name and corporate seal of each corporate party being hereto affixed and these presents duly signed by its undersigned representative, pursuant to authority of its governing body.

Contract No. C205035
County Wayne

Rev. 10-31-24

CONTRACT PAYMENT BOND

Hartford Fire Insurance Company NAIC #19682
Berkshire Hathaway Specialty Insurance Company NAIC #22276
Print or type Surety Company Name NAIC #

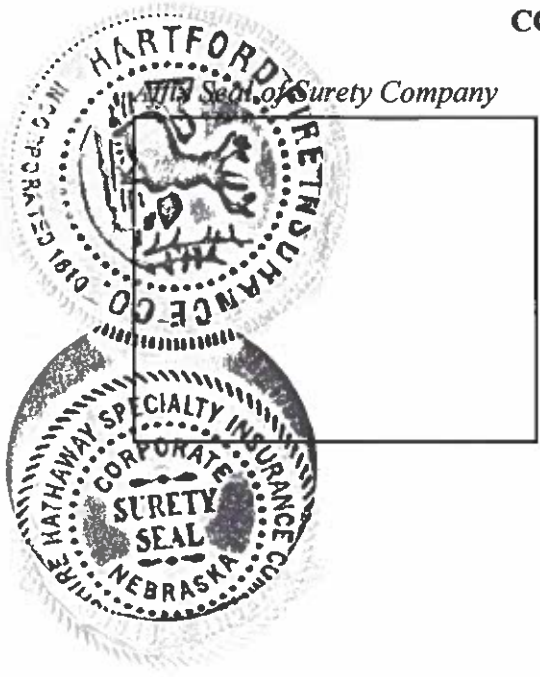

By Marisol Mojica, Attorney-in-Fact
Print, stamp or type name of Attorney-in-Fact

Marisol Mojica
Signature of Attorney-in-Fact

Cole
Signature of Witness

Cole Walinsky, Witness to Surety
Print or type Signer's name

One Hartford Plaza, Hartford, CT 06155
1314 Douglas Street, Suite 1400, Omaha, NE 68102
Address of Attorney-in-Fact

Contract No. C205035
County Wayne

Rev. 10-31-24

CONTRACT PAYMENT BOND

CORPORATION

SIGNATURE OF CONTRACTOR (Principal)

Branch Civil, Inc.
Full name of Corporation

3635 Peter's Creek Rd, Roanoke, VA 24019
Address as prequalified

By 
Signature of President Vice President, Assistant Vice President
Select appropriate title



Affix Corporate Seal

BRIAN J QUINLAN
Print or type Signer's name

Attest 
Signature of Secretary Assistant Secretary
Select appropriate title

Jeffrey M. Bourne
Print or type Signer's name

Contract No. C205035
County Wayne

Rev. 10-31-24

Bond Numbers:
Hartford Fire Insurance Company - 44BCSJK9419
Berkshire Hathaway Specialty Insurance Company - 47-SUR-300171-01-0103

CONTRACT PERFORMANCE BOND

Date of Performance Bond Execution: March 4, 2026

Name of Principal Contractor: Branch Civil, Inc.
Hartford Fire Insurance Company, One Hartford Plaza, Hartford, CT 06155

Name of Surety: Berkshire Hathaway Specialty Insurance Company, 1314 Douglas Street, Suite 1400, Omaha, NE 68102

Name of Contracting Body: North Carolina Department of Transportation
Raleigh, North Carolina
Thirty Million Seven Hundred Fifteen Thousand One Hundred Eighty-Five and 00/100 (\$30,715,185.00)

Amount of Bond: (\$30,715,185.00)

Contract ID No.: C205035

County Name: Wayne

KNOW ALL MEN BY THESE PRESENTS, That we, the PRINCIPAL CONTRACTOR (hereafter, PRINCIPAL) and SURETY above named, are held and firmly bound unto the above named Contracting Body, hereinafter called the Contracting Body, in the penal sum of the amount stated above for the payment of which sum well and truly to be made, we bind ourselves, our heirs, executors, administrators, and successors, jointly and severally, firmly by these presents.

THE CONDITION OF THIS OBLIGATION IS SUCH, that whereas the principal entered into a certain contract with the Contracting Body, numbered as shown above and hereto attached:

NOW THEREFORE, if the principal shall well and truly perform and fulfill all the undertakings, covenants, terms, conditions, and agreements of said contract during the original term of said contract and any extensions thereof that may be granted by the Contracting Body, with or without notice to the Surety, and during the life of any guaranty required under the contract, and shall also well and truly perform and fulfill all the undertakings, covenants, terms, conditions, and agreements of any and all duly authorized modifications of said contract that may hereafter be made, notice of which modifications to the surety being hereby waived, then this obligation to be void; otherwise to remain in full force and virtue.

IN WITNESS WHEREOF, the above-bound parties have executed this instrument under their several seals on the date indicated above, the name and corporate seal of each corporate party being hereto affixed and these presents duly signed by its undersigned representative, pursuant to authority of its governing body.

Contract No. C205035
County Wayne

Rev. 10-31-24

CONTRACT PERFORMANCE BOND

Hartford Fire Insurance Company NAIC #19682
Berkshire Hathaway Specialty Insurance Company NAIC #22276
Print or type Surety Company Name NAIC #



By Marisol Mojica, Attorney-in-Fact
Print, stamp or type name of Attorney-in-Fact

Marisol Mojica
Signature of Attorney-in-Fact

Cole Walinsky
Signature of Witness

Cole Walinsky, Witness to Surety
Print or type Signer's name

One Hartford Plaza, Hartford, CT 06155
1314 Douglas Street, Suite 1400, Omaha, NE 68102
Address of Attorney-in-Fact

Contract No. C205035
County Wayne

Rev. 10-31-24

CONTRACT PERFORMANCE BOND

CORPORATION

SIGNATURE OF CONTRACTOR (Principal)

Branch Civil, Inc.
Full name of Corporation

3635 Peter's Creek Rd, Roanoke, VA 24019
Address as prequalified

By 
Signature of President, Vice President, Assistant Vice President
Select appropriate title



Affix Corporate Seal

BRIAN J QUINLAN
Print or type Signer's name

Attest 
Signature of Secretary, Assistant Secretary
Select appropriate title

Jeffrey M. Bourne
Print or type Signer's name

POWER OF ATTORNEY

Direct Inquiries, Bond Authenticity
and Claims to:
THE HARTFORD
BOND, T-14
One Hartford Plaza
Hartford, Connecticut 06155
Bond.Claims@thehartford.com
call: 888-266-3488 or fax: 860-757-5835

KNOW ALL PERSONS BY THESE PRESENTS THAT:

Agency Name: AMERICAN GLOBAL LLC
Agency Code: 36-215890

- Hartford Fire Insurance Company**, a corporation duly organized under the laws of the State of Connecticut
- Hartford Casualty Insurance Company**, a corporation duly organized under the laws of the State of Indiana
- Hartford Accident and Indemnity Company**, a corporation duly organized under the laws of the State of Connecticut
- Hartford Insurance Company of the Midwest**, a corporation duly organized under the laws of the State of Indiana

having their home office in Hartford, Connecticut, (hereinafter collectively referred to as the "Companies") do hereby make, constitute and appoint, **up to the amount of** Unlimited :

Andrea E. Gorbett, Mariya Leonidov of Jericho NY, Ryan Gray, Jaclyn Maffey, Marisol Mojica, Andrea Moran, Krystal L. Stravato, Kevin T. Walsh, Jr., Dipal Savaliya of Whippany NJ, Nick Bokios, Diana Baker of Schaumburg IL, Ricardo Davila, William Grefe Griffin, Michael Marino, Torre Taylor of PLANTATION, Florida

their true and lawful Attorney(s)-in-Fact, each in their separate capacity if more than one is named above, to sign its name as surety(ies) only as delineated above by , and to execute, seal and acknowledge any and all bonds, undertakings, contracts and other written instruments in the nature thereof, on behalf of the Companies in their business of guaranteeing the fidelity of persons, guaranteeing the performance of contracts and executing or guaranteeing bonds and undertakings required or permitted in any actions or proceedings allowed by law.

In Witness Whereof, and as authorized by a Resolution of the Board of Directors of the Companies on May 23, 2016 the Companies have caused these presents to be signed by its Assistant Vice President and its corporate seals to be hereto affixed, duly attested by its Assistant Secretary. Further, pursuant to Resolution of the Board of Directors of the Companies, the Companies hereby unambiguously affirm that they are and will be bound by any mechanically applied signatures applied to this Power of Attorney.



Phyllis A. Clark

Phyllis A. Clark, Assistant Secretary

Joelle L. LaPierre

Joelle L. LaPierre, Assistant Vice President

STATE OF FLORIDA

COUNTY OF SEMINOLE

ss. Lake Mary

On this 1st day of March, 2024, before me personally came Joelle L. LaPierre, to me known, who being by me duly sworn, did depose and say: that (s)he resides in Seminole County, State of Florida; that (s)he is the Assistant Vice President of the Companies, the corporations described in and which executed the above instrument; that (s)he knows the seals of the said corporations; that the seals affixed to the said instrument are such corporate seals; that they were so affixed by authority of the Boards of Directors of said corporations and that (s)he signed his/her name thereto by like authority.



Mariluz Arce

Mariluz Arce
My Commission HH 287363
Expires July 13, 2026

I, the undersigned, Assistant Vice President of the Companies, DO HEREBY CERTIFY that the above and foregoing is a true and correct copy of the Power of Attorney executed by said Companies, which is still in full force effective as of March 4, 2026.

Signed and sealed in Lake Mary, Florida.



Keith D. Dozois

Keith D. Dozois, Assistant Vice President

Power Of Attorney

BERKSHIRE HATHAWAY SPECIALTY INSURANCE COMPANY NATIONAL INDEMNITY COMPANY / NATIONAL LIABILITY & FIRE INSURANCE COMPANY

Know all men by these presents, that **BERKSHIRE HATHAWAY SPECIALTY INSURANCE COMPANY** and **NATIONAL INDEMNITY COMPANY**, corporation existing under and by virtue of the laws of the State of Nebraska, and **NATIONAL LIABILITY & FIRE INSURANCE COMPANY**, a corporation existing under and by virtue of the laws of the State of Connecticut (hereinafter collectively the "Companies"), pursuant to and by the authority granted as set forth herein, do hereby name, constitute and appoint **Marisol Mojica, Kevin T. Walsh, Jr., Thomas MacDonald, Krystal L. Stravato, Andreah Moran, Ryan Gray, Dipal Savaliya, Jaclyn Maffey** located at **100 South Jefferson Road, Suite 101, of the city of Whippany, State of New Jersey** as their true and lawful attorney(s)-in-fact to make, execute, seal, acknowledge, and deliver, for and on their behalf as surety and as their act and deed, any and all undertakings, bonds, bid related commitments to include surety consents, surety consents for release or reduction of retained percentages, final estimates on engineering and construction contracts or other such writings obligatory in the nature thereof, in pursuance of these presents, the execution of which shall be as binding upon the Companies as if it has been duly signed and executed by their regularly elected officers in their own proper persons. This authority for the Attorney-in-Fact shall be limited to the execution of the attached bond(s) or other such related writings obligatory in the nature thereof as described herein.

In witness whereof, this Power of Attorney has been subscribed by an authorized officer of the Companies, and the corporate seals of the Companies have been affixed hereto this date 17th of September, 2025. This Power of Attorney is made and executed pursuant to and by authority of the Bylaws, Resolutions of the Board of Directors, and other Authorizations of **BERKSHIRE HATHAWAY SPECIALTY INSURANCE COMPANY**, **NATIONAL INDEMNITY COMPANY** and **NATIONAL LIABILITY & FIRE INSURANCE COMPANY**, which are in full force and effect, each reading as appears on the back page of this Power of Attorney, respectively. The following seals of the Companies and signatures by authorized officer of the Companies may be affixed by facsimile or digital format, which shall be deemed the equivalent of and constitute the written signatures of such officer of the Companies and original seals of the Companies for all purposes regarding this Power of Attorney, including satisfaction of any signature and seal requirements on any and all undertakings, bonds, or other such writings obligatory in the nature thereof, to which this Power of Attorney applies.



By: _____
David Fields, Executive Vice President



NATIONAL INDEMNITY COMPANY,
NATIONAL LIABILITY & FIRE
INSURANCE COMPANY,

[Signature]

By: _____
David Fields, Vice President



NOTARY

State of Massachusetts, County of Suffolk, ss:

On this 17th day of September, 2025 before me appeared David Fields, Executive Vice President of **BERKSHIRE HATHAWAY SPECIALTY INSURANCE COMPANY** and Vice President of **NATIONAL INDEMNITY COMPANY** and **NATIONAL LIABILITY & FIRE INSURANCE COMPANY**, who being duly sworn, says that his capacity is as designated above for such Companies; that he knows the corporate seals of the Companies; that the seals affixed to the foregoing instrument are such corporate seals; that they were affixed by order of the board of directors or other governing body of said Companies pursuant to its Bylaws, Resolutions and other Authorizations, and that he signed said instrument in that capacity of said Companies.

[Notary Seal]



CAITLIN NICOLE BOYDEN
Notary Public
Commonwealth of Massachusetts
My Commission Expires
September 7, 2029

[Signature]

Notary Public

I, **Ralph Tortorella III**, the undersigned, Officer of **BERKSHIRE HATHAWAY SPECIALTY INSURANCE COMPANY**, **NATIONAL INDEMNITY COMPANY** and **NATIONAL LIABILITY & FIRE INSURANCE COMPANY**, do hereby certify that the above and foregoing is a true and correct copy of the Power of Attorney executed by said Companies which is in full force and effect and has not been revoked. IN TESTIMONY WHEREOF, see hereunto affixed the seals of said Companies this March 4, 2026.

[Signature]

Ralph Tortorella III, Officer

To verify the authenticity of this Power of Attorney please contact us at: BHSI Surety Department, Berkshire Hathaway Specialty Insurance Company, 100 Federal Street, 7th Floor, Boston, MA 02110 | (770-625-2516) or by email at BHSI@andco.bhspci.com THIS POWER OF ATTORNEY IS VOID IF ALTERED

Notify us of a claim: 24-hour toll free number (855) 453-9675, email surety.net@bhspci.com, fax (617) 507-8259, or mail.